

0000-000-37161

SIGNAL\_1 COMP SIDE 2A1

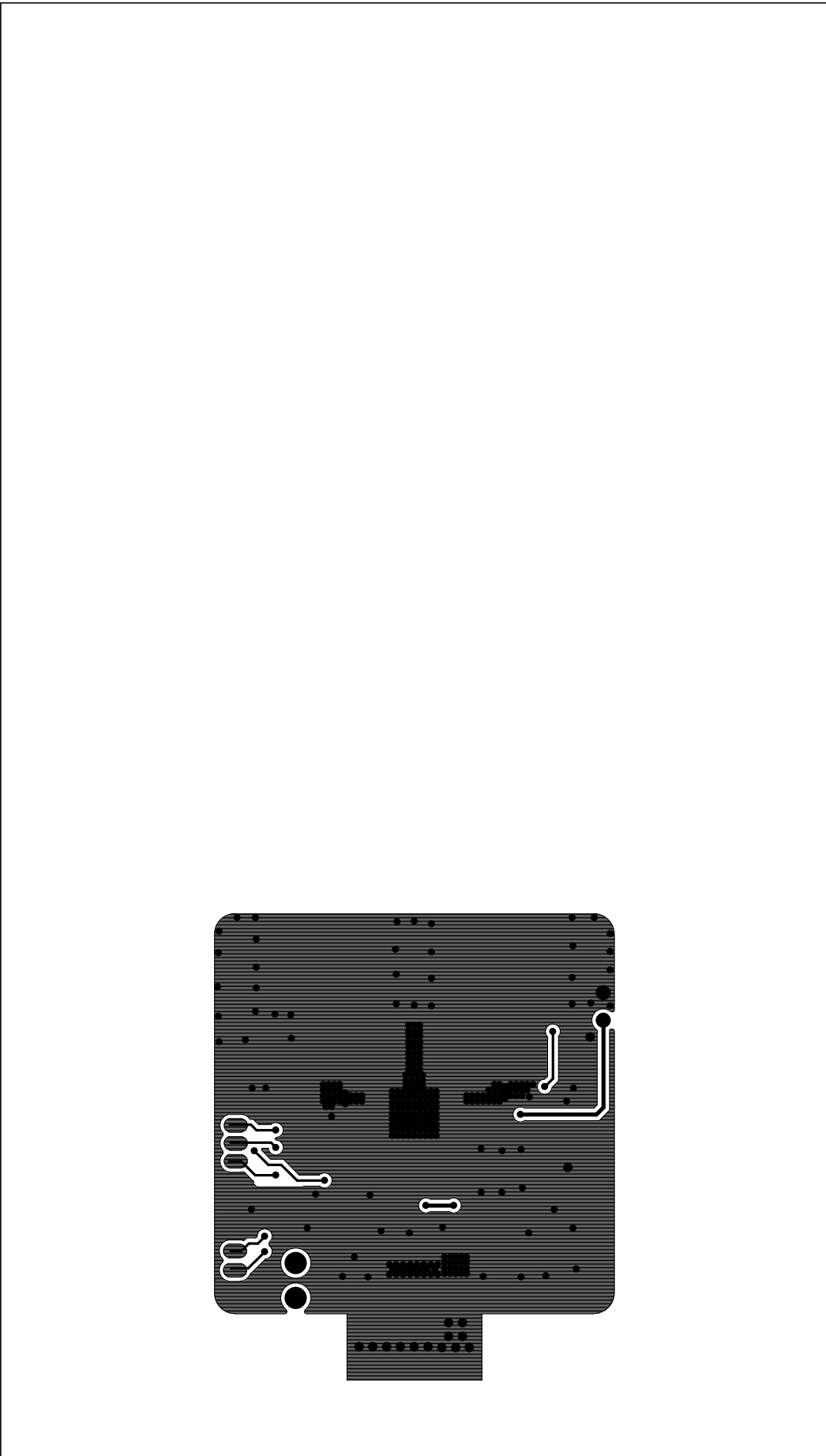

0000-000-37161

SIGNAL\_2 SOLDER SIDE 2A2

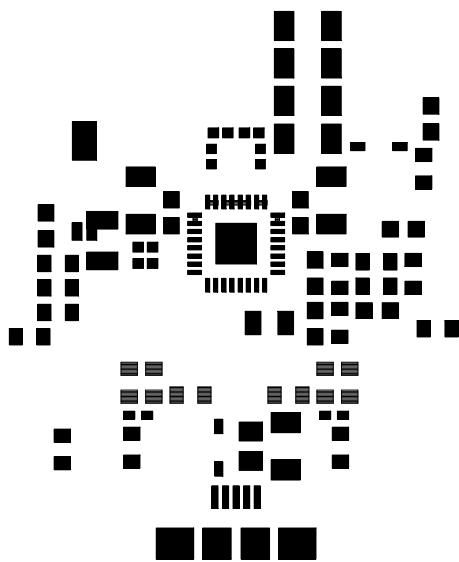

0000-000-37161

SOLDERPASTE\_1 COMP SIDE 2A0

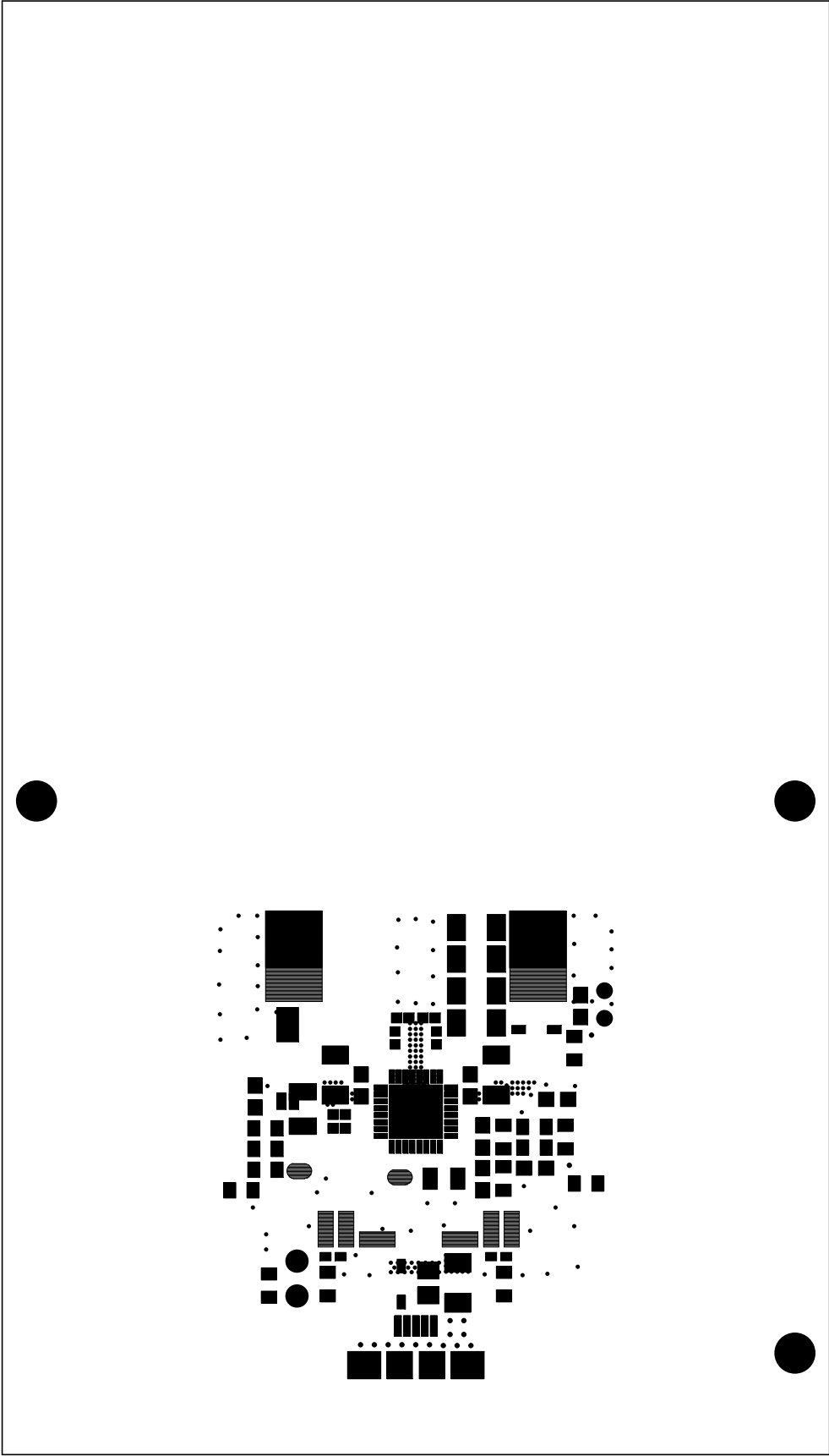

0000-000-37161

SOLDERMASK\_1 COMP SIDE 2A00

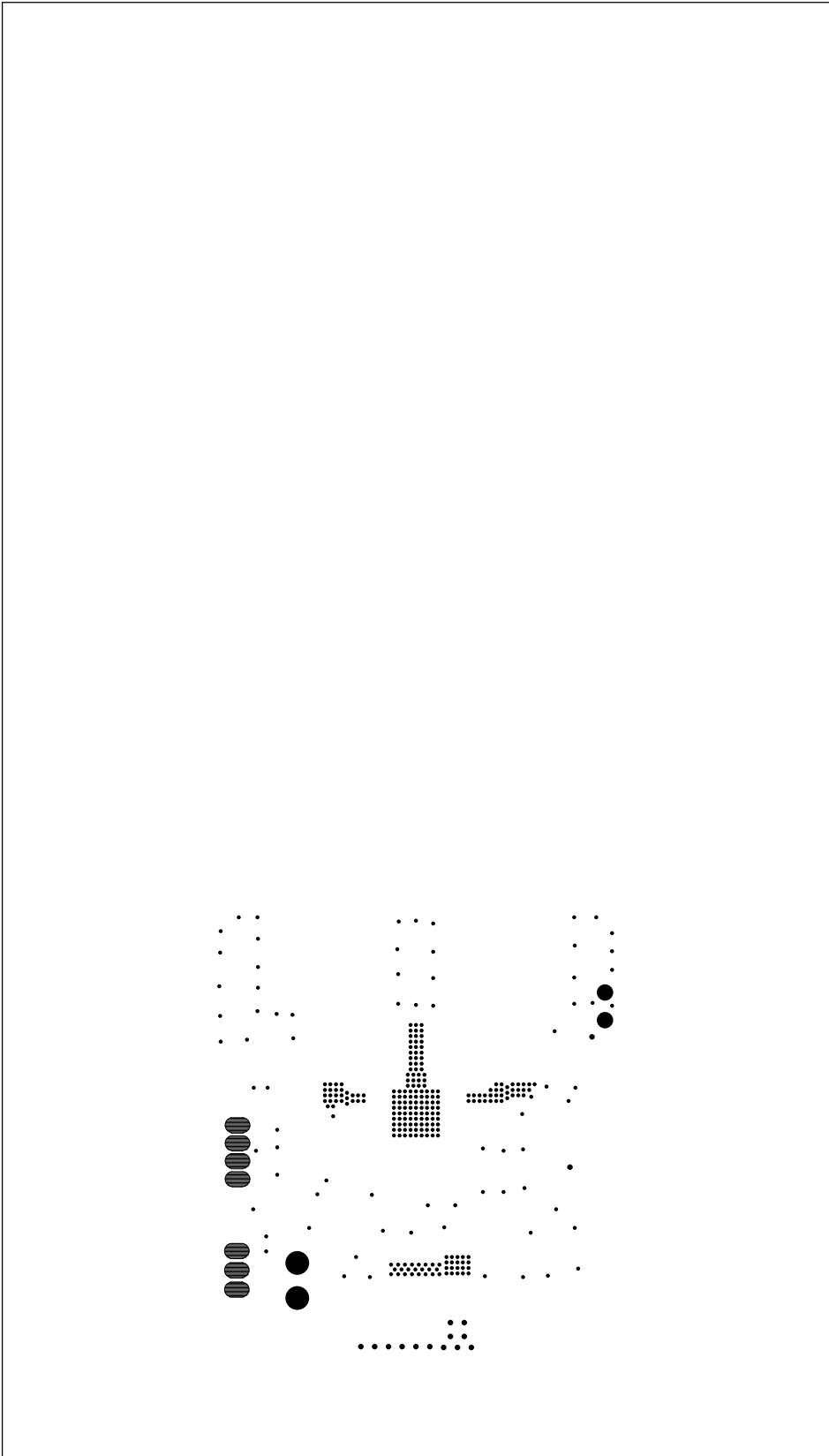

0000-000-37161

SOLDERMASK\_2 SOLDER SIDE 2B00

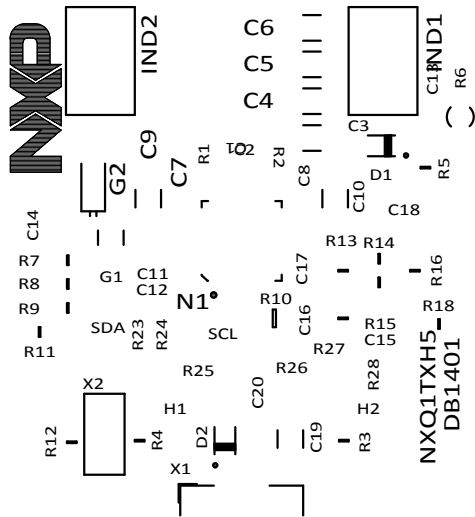
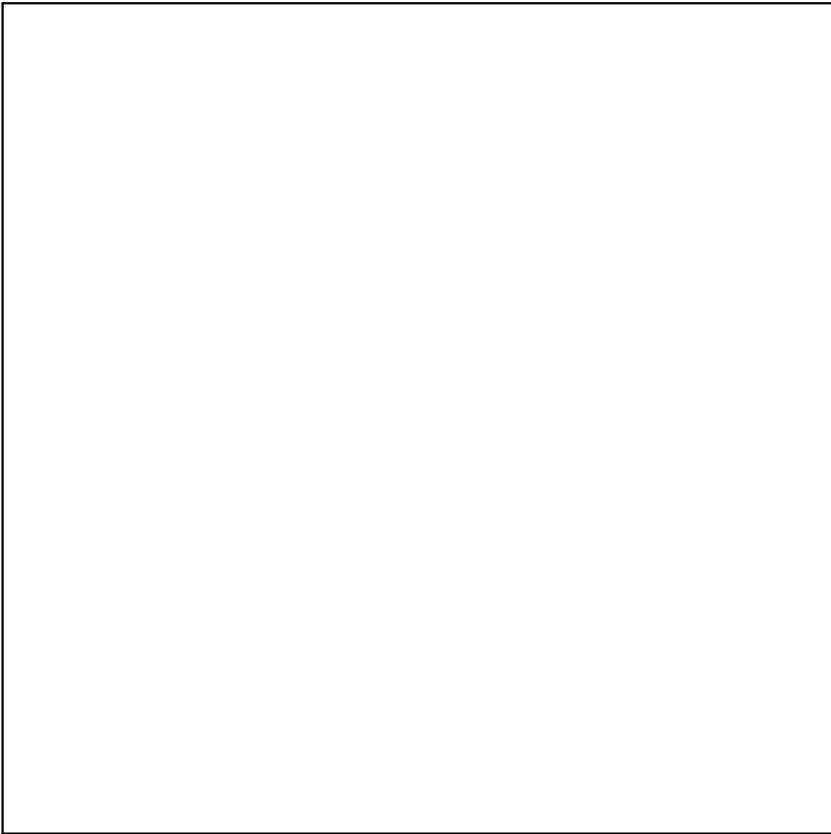

0000-000-37161

SILKSCREEN\_1 COMP SIDE 2A000

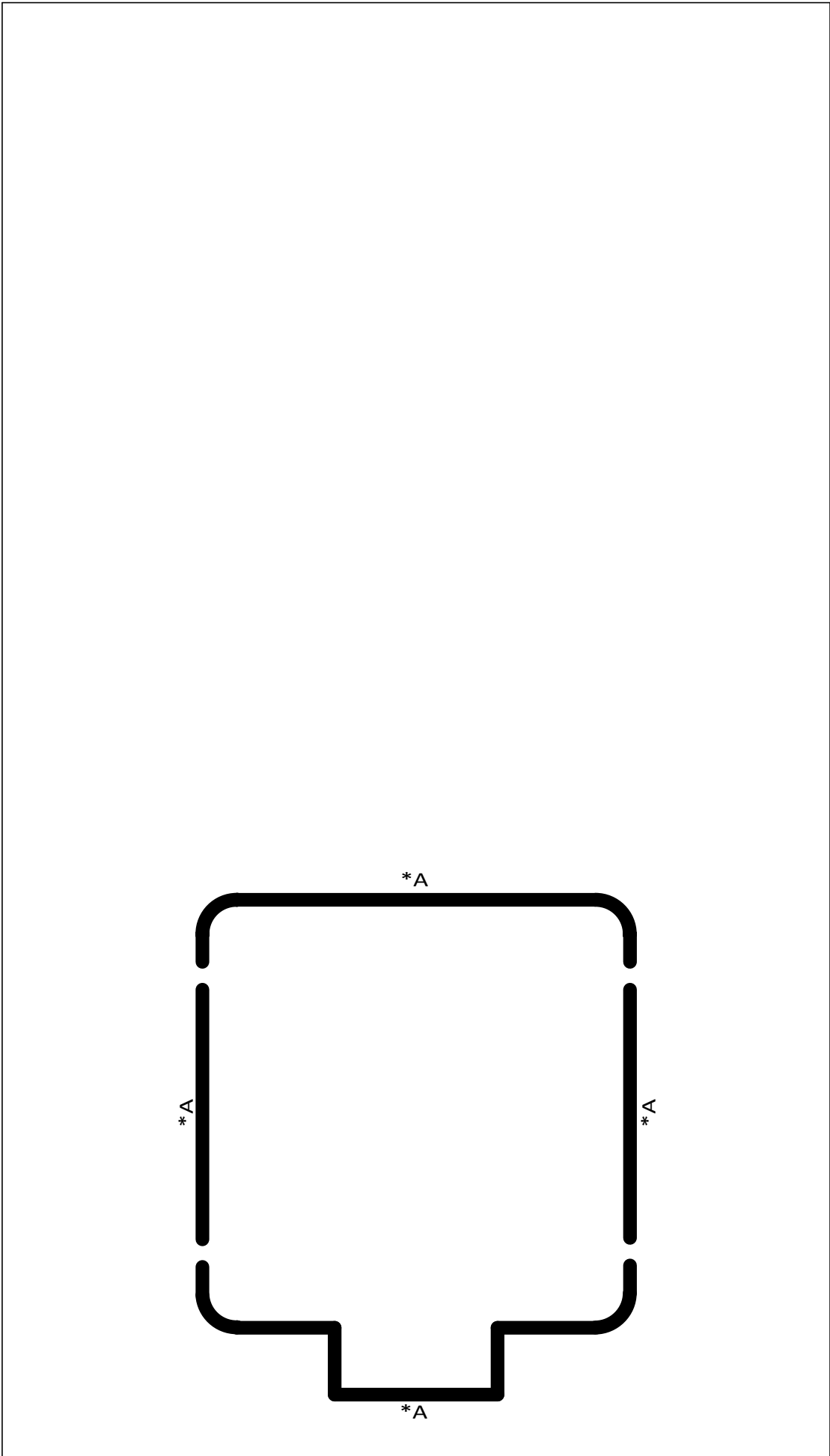

0000-000-37161

\*A) MILLING THICKNESS 1.00 +0.00MM \*A  
-0.10MM

MILLING NON PLATING

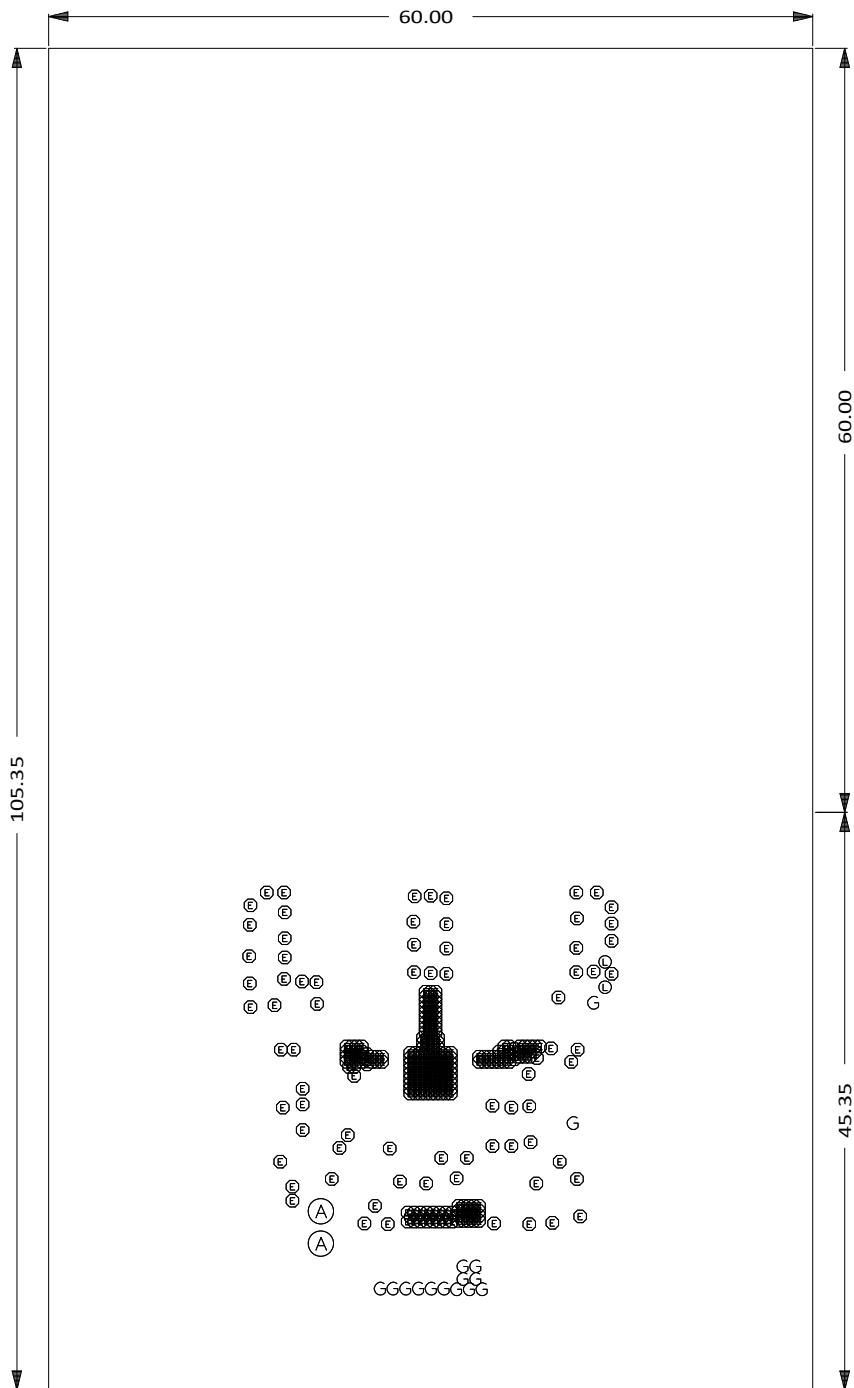

DRILL CHART: TOP to BOTTOM				
ALL UNITS ARE IN MILLIMETERS				
FIGURE	SIZE	PLATED	NONSTANDARD	QTY
E	0.2000	PLATED	FILLED AND CAPPED	300
G	0.3000	PLATED	-	15
L	0.5000	PLATED	-	2
A	1.0000	PLATED	-	2
TOTAL HOLES:				319

0000-000-37161 DRILL DRAWING



