

The mX-LPC11U14-S schematic and mX-LPC1343-Link schematic are included as two separate pages

Sheet: Sheet4D9482EB

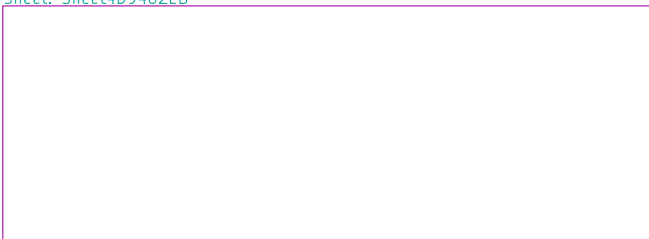

File: mX-LPC11U14-S.sch

mX-LPC11U14-S Schematic

Sheet: Sheet4D948308

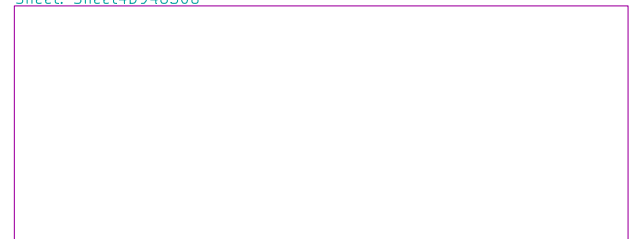

File: mX-LPC1343.sch

mX-LPC1343 Schematic

File: mX-LPC11U14.sch		
Sheet: /		
Title:		
Size: A4	Date: 29 apr 2011	Rev:
KiCad E.D.A. eeschema (2010-05-05 BZR 2356)-stable		Id: 1/3

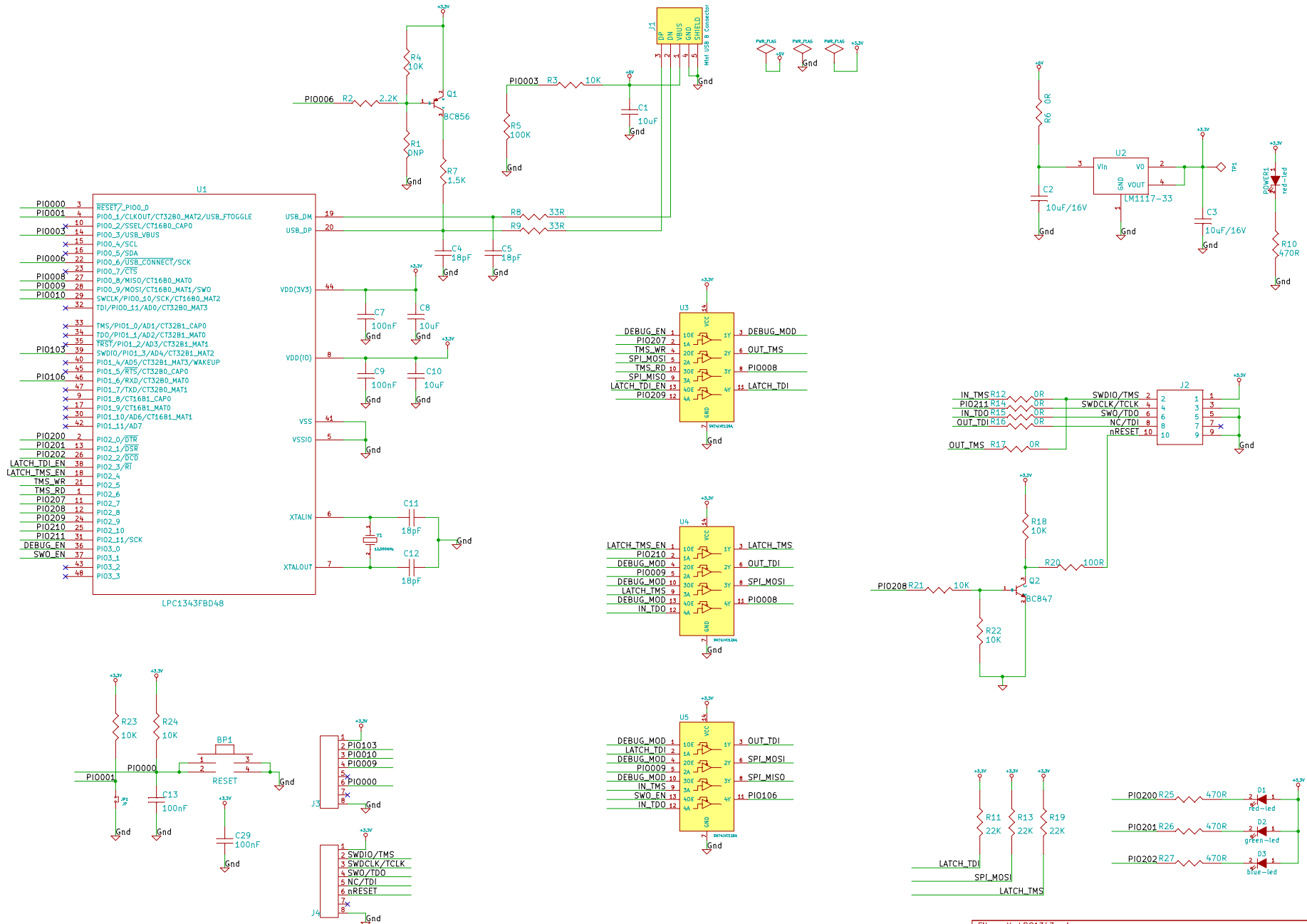

File: mX-LPC1343.sch			
Sheet: /Sheet4D948308/			
Title:			
Size: A3	Date: 29 apr 2011	Rev:	
KiCad E.D.A. eeschema (2010-05-05 BZR 2356) -stable		Id: 2/3	

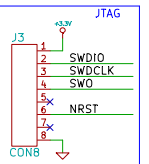
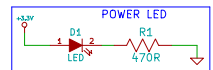

mX-BASE BOARD PIN OUT	mX-LPC11U14-S PIN OUT
GND	GND
VIN	VIN
VBAT	NC
RESET#	NRST
MOSI	SWO
MISO	PI00_8
SCK	PI01_29
SSEL	PI00_2
TXD	PI00_19
RXD	PI01_6
EXT_SW	PI00_7
TXD1	PI01_20
RXD1	PI01_21
VGA_R	PI00_11
VGA_G	PI00_12
VGA_B	PI00_13
AOUT	PI00_14
ADC	PI00_16
NC	PI00_17
NC	PI00_20
USB_CONNECT	PI00_6
SWCLK	SWDCLK
LCD_EN	PI01_13
LCD_RW	PI01_14
LCD_RS	PI01_15

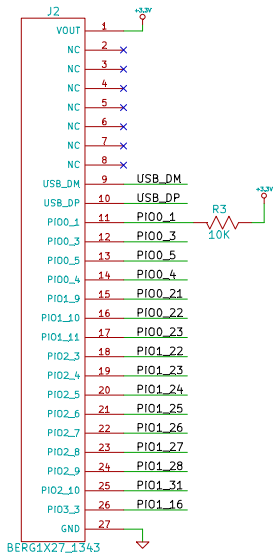
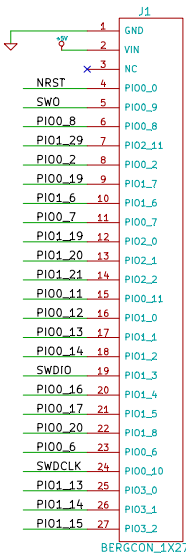

mX-LPC11U14-S PIN OUT	MX_BASE BOARD PIN OUT
+3.3V	+3.3V
NC	USB_5V
NC	NC
NC	NC
NC	NC
NC	E_RD-
NC	E_RD+
NC	E_TD-
NC	E_TD+
USB_DM	USB_DM
USB_DP	USB_DP
PI00_1	ISP
PI00_3	VBUS
PI00_5	SDA
PI00_4	SCL
PI00_21	VGA_VSYNC
PI00_22	VGA_HSYNC
PI00_23	BUZZER
PI01_22	PWM2
PI01_23	PS2_DATA
PI01_24	PS2_CLK
PI01_25	LCD_D4
PI01_26	LCD_D5
PI01_27	LCD_D6
PI01_28	LCD_D7
PI01_31	
PI01_16	
GND	GND