

UM11436

PCA9959 Evaluation board OMPCA9959LEDEV

Rev. 1.0 — 27 April 2020

User manual

Document information

Information	Content
Keywords	SPI-bus, PCA9959, RGB and White LEDs, 24-channel x 6-bit brightness, 64 grids for gradation control.
Abstract	The OMPCA9959LEDEV eval board allows test and design for the PCA9959, which is a 24-channel SPI 4-wire bus 63 mA/5.5V constant current LED driver. This eval board, along with the OM13089 MCU board, provides an easy to use evaluation platform.



Revision history

Revision history

Rev	Date	Description
v.1.0	20200427	Initial version

1 Introduction

The PCA9959 evaluation board features LEDs for color mixing, blinking and dimming demonstrations. A graphical interface allows the user to easily explore the different functions of the driver. The board can be connected in series with other SPI-bus demo-boards to create an evaluation system.

The IC communicates to the host via the industry standard SPI-bus port. The evaluation software runs under Microsoft Windows 7, 8, and 10 PC platform.

2 Features

- A complete evaluation platform for the PCA9959 24-channel SPI-bus 63 mA/5.5V constant current LED driver
- Easy to use GUI based software demonstrates the capabilities of the PCA9959.
- On-board Infrared, blue and RGB LEDs for variable experiments
- Convenient test points for easy scope measurements and signal access
- USB interface to the host PC
- Power supply from USB port (x2) or external power supply can be used to power PCA9959 evaluation board

3 Getting started

3.1 Assumptions

Familiarity with the SPI-bus is helpful but not required.

3.2 Static handling requirements

CAUTION



This device is sensitive to ElectroStatic Discharge (ESD). Therefore care should be taken during transport and handling. You must use a ground strap or touch the PC case or other grounded source before unpacking or handling the hardware.

3.3 Minimum system requirements

- PC Pentium processor (or equivalent)
- One USB port (either 3.0 or 2.0 or 1.1 compatible)
- Windows 7, 8, or 10
- OM13089 MCU board (www.nxp.com)

3.4 Power requirements

The OM13089 MCU board obtains power from the PC USB port, two USB parts can be connected to the OM13089 MCU board simultaneously. Please use external power supply option if exceeding the USB port current capabilities.

4 Hardware installation

4.1 OMPCA9959LEDEV EV board and OM13089 MCU board connection

OMPCA9959LEDEV evaluation board is connected to the OM13089 MCU board using two connectors (J1 & J2 on OMPCA9959LEDEV board and J1 & J8 on OM13089 board).

The OM13089 MCU board communicates with PCA9959 demo GUI through PC USB port and uses SPI bus to communicate to PCA9959.

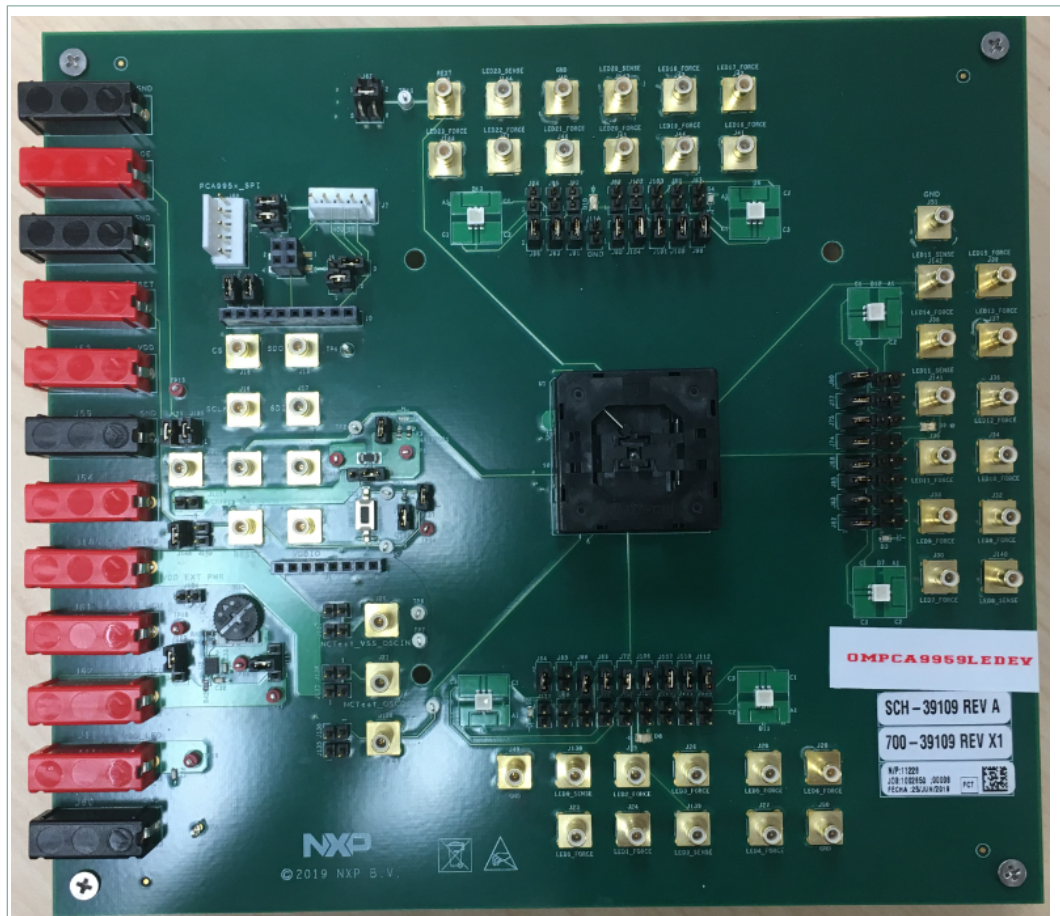

Figure 1. OMPCA9959LEDEV evaluation board

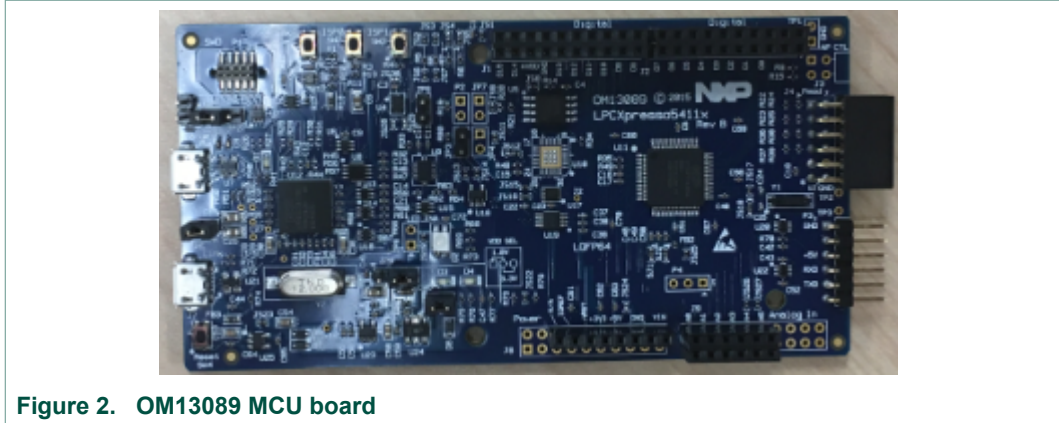
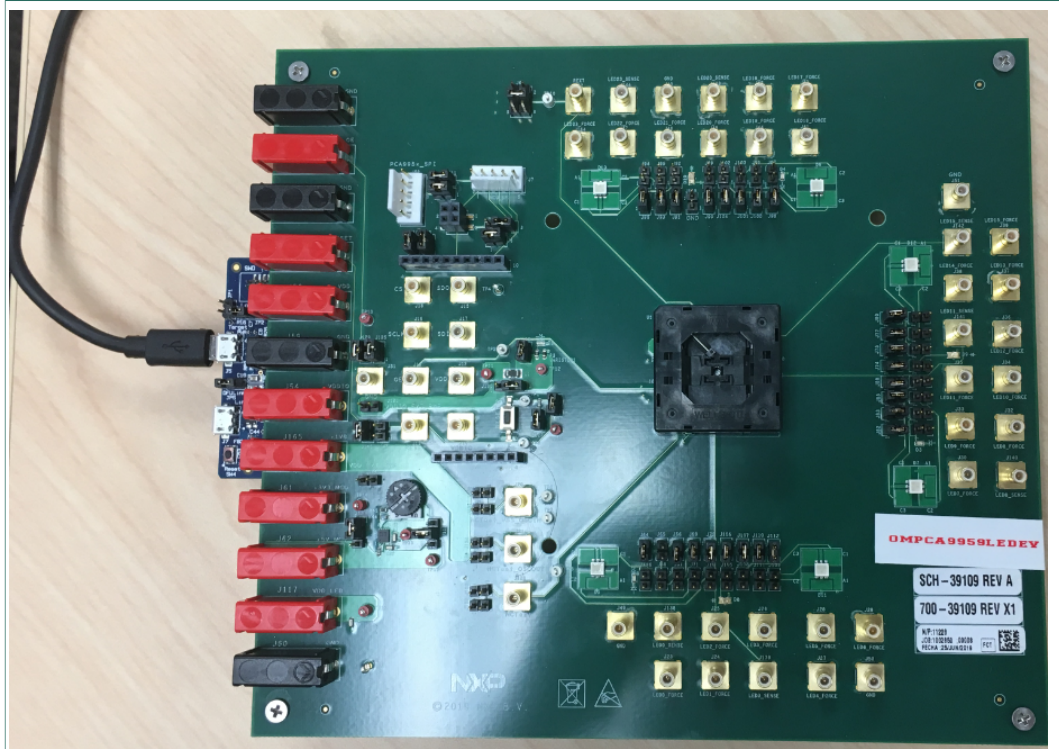

Figure 2. OM13089 MCU board

- OMPCA9959LEDEV evaluation board connecting to the OM13089 MCU board



- Use J5 (USB Micro-B connector) on OM13089 for power supply and GUI communication port.
- Use J7 (USB Micro-B connector) on OM13089 for additional power supply

Figure 3. OMPCA9959LEDEV evaluation board

5 Hardware description

- J1 and J2 are connected to the PM13089 MCU board.
- J123 selects PCA9959 VDD power supply.
- J120 selects PCA9959 VDDIO power supply.
- J113 selects LED power supply.

Table 1. OMPCA9959LEDEV EV board main components

Device	Description	Location
PCA9959	24-channel SPI-bus 32mA/5.5V constant current LED driver	U2
LP38502SD-ADJ	Adjustable output voltage LDO	U3
Green LED	Green LED for power supply indicator	D1
APT1608QBC/D	Blue LED	D2, D3, D4
SCM-013RT	Infrared LED	D8, D9, D10
LRTB GVSG	RGB LED	D5, D6, D7, D11, D12, D13

Table 2. Jumper settings for power supply

Jumper	Default setting	Comment
J123	1-2	1-2: Use +3V3 power supply for VDD 3-4: Use +5V power supply for VDD Open: Use external power supply from J124
J124	N/A	External power supply for VDD
J125	1-2	1-2: LED output enabled Open: LED disabled
J129	Open	1-2: LED output disabled Open: LED output enabled
J120	1-2	1-2: Use external power supply from J121 3-4: Use VDD_IN for VDDIO power supply
J121	N/A	External power supply for VDDIO
J118	1-2	1-2 : Not measuring VDD current Open: Use current meter to measure VDD current
J122	1-2	1-2 : Not measuring VDDIO current Open: Use current meter to measure VDDIO current
J137	1-2	1-2 : Use external POR circuit Open: Use internal POR circuit
J113	1-2	1-2: LED power supply from +5V_MCU 4-2: LED power supply from VOUT_ADJ 3-2: LED power supply from +3V3_MCU
J63	1-2	REXT = 1 kohm, Iref = 250 uA Output current = Iref * IREF_GRPx[7:0].

Table 3. Jumper settings Host interface

Jumper	Default setting	Comment
J1	N/A	Power supply from OM13089 MCU board

Jumper	Default setting	Comment
J2	N/A	SPI bus interface to the OM13089 MCU board
J3, J4	N/A	For OMPCA9959LEDEV SPI daisy chain test
J5	1-2	MISO
J6	1-2	MOSI
J7	N/A	SPI bus test points
J8,J9,J10,J11	1-2	SPI bus
J52	N/A	SPI bus test points

Table 4. Jumper settings for LEDs

Jumper	Default setting	Comment
J64	1-2	D2 - Blue LED 1-2: Not measuring D2 current Open: Use current meter to measure D2 current
J116	Open	D2 - Blue LED 1-2: Bypass D2 LED Open: Use D2 LED
J82	1-2	D3 - Blue LED 1-2: Not measuring D3 current Open: Use current meter to measure D3 current
J81	Open	D3 - Blue LED 1-2: Bypass D3 LED Open: Use D3 LED
J98	1-2	D4 - Blue LED 1-2: Not measuring D4 current Open: Use current meter to measure D4 current
J97	Open	D4 - Blue LED 1-2: Bypass D4 LED Open: Use D4 LED
J66, J69, J72	1-2	D5 - RGB LED 1-2: Not measuring D5 current Open: Use current meter to measure D5 current
J67, J70, J71	Open	D5 - RGB LED 1-2: Bypass D5 LED Open: Use D5 LED
J100, J101, J104	1-2	D6 - RGB LED 1-2: Not measuring D6 current Open: Use current meter to measure D6 current
J99, J102, J103	Open	D6 - RGB LED 1-2: Bypass D6 LED Open: Use D6 LED
J83, J85, J88	1-2	D7 - RGB LED 1-2: Not measuring D7 current Open: Use current meter to measure D7 current
J84, J86, J87	Open	D7 - RGB LED 1-2: Bypass D7 LED Open: Use D7 LED
J106	1-2	D8 - Infrared LED 1-2: Not measuring D8 current Open: Use current meter to measure D8 current
J105	Open	D8 - Infrared LED 1-2: Bypass D8 LED Open: Use D8 LED
J74	1-2	D9 - Infrared LED 1-2: Not measuring D9 current Open: Use current meter to measure D9 current
J73	Open	D9 - Infrared LED 1-2: Bypass D9 LED Open: Use D9 LED
J90	1-2	D10 - Infrared LED 1-2: Not measuring D10 current Open: Use current meter to measure D10 current
J89	Open	D10 - Infrared LED 1-2: Bypass D10 LED Open: Use D10 LED
J107, J110, J112	1-2	D11 - RGB LED 1-2: Not measuring D11 current Open: Use current meter to measure D11 current
J108, J109, J111	Open	D11 - RGB LED 1-2: Bypass D11 LED Open: Use D11 LED

Jumper	Default setting	Comment
J75, J77, J80	1-2	D12 - RGB LED 1-2: Not measuring D12 current Open: Use current meter to measure D12 current
J76, J78, J79	Open	D12 - RGB LED 1-2: Bypass D12 LED Open: Use D12 LED
J91, J93, J96	1-2	D13 - RGB LED 1-2: Not measuring D13 current Open: Use current meter to measure D13 current
J92, J94, J95	Open	D13 - RGB LED 1-2: Bypass D13 LED Open: Use D13 LED

Table 5. Jumper settings for SMB connectors

Jumper	Default setting	Comment
J12	N/A	VDD SMB connector
J13	N/A	/RESET pin SMB connector
J14	N/A	VDDIO SMB connector
J15	N/A	SDO pin SMB connector
J16	N/A	SCLK pin SMB connector
J17	N/A	SDI pin SMB connector
J18	N/A	/CS pin SMB connector
J19	N/A	/OE pin SMB connector
J20	N/A	NCTest_VSS_OSCIN SMB connector
J21	N/A	NCTest_OSCOUT SMB connector
J22	N/A	REXT pin SMB connector
J23 - J30	N/A	LED 0 - 7 pin SMB connector
J31, J40, J49-J51	N/A	GND SMB connector
J32 - J39	N/A	LED 8 - 15 pin SMB connector
J41 - J47, J164	N/A	LED 16 - 23 pin SMB connector

Table 6. Jumper settings for banana connectors

Jumper	Default setting	Comment
J53	N/A	VDD banana connector
J54	N/A	VDDIO banana connector
J55	N/A	/OE pin banana connector
J56	N/A	/RESET pin banana connector
J57 - J60	N/A	GND banana connector
J61	N/A	3V3_MCU banana connector
J62	N/A	3V_MCU banana connector
J165	N/A	1V8 banana connector

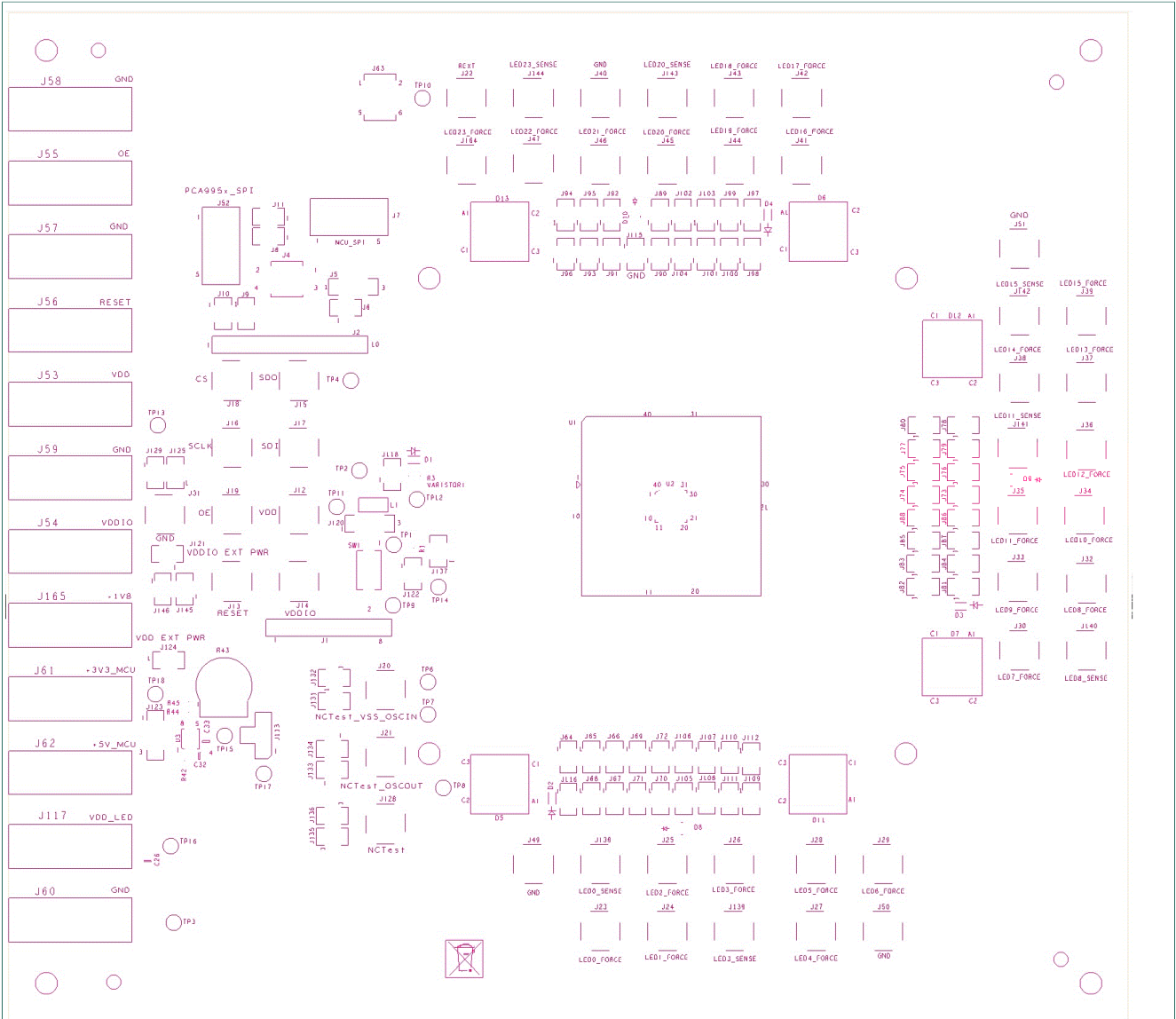

Figure 4. Jumpers and test points location

6 Schematic

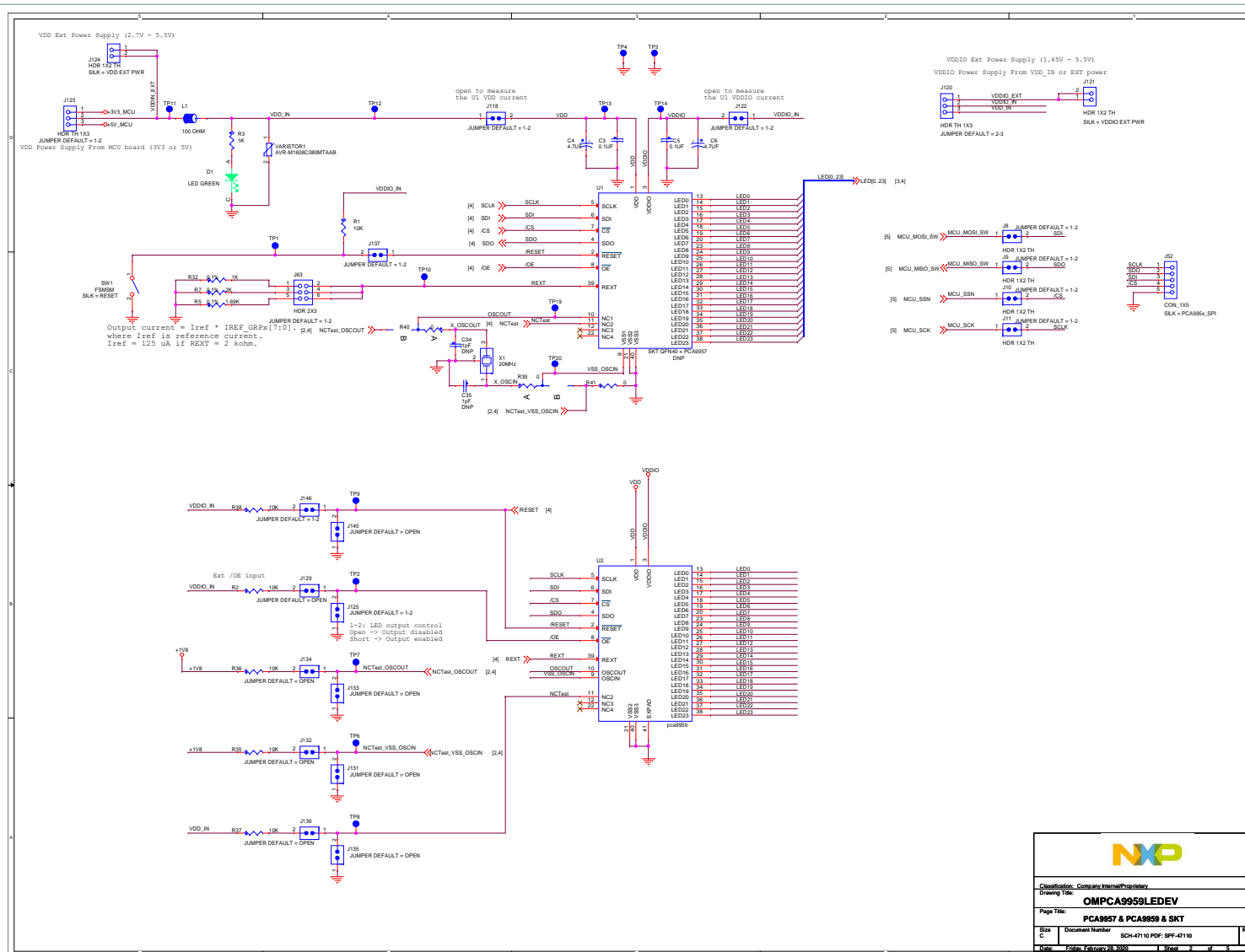

Figure 5. PCA9959 schematic

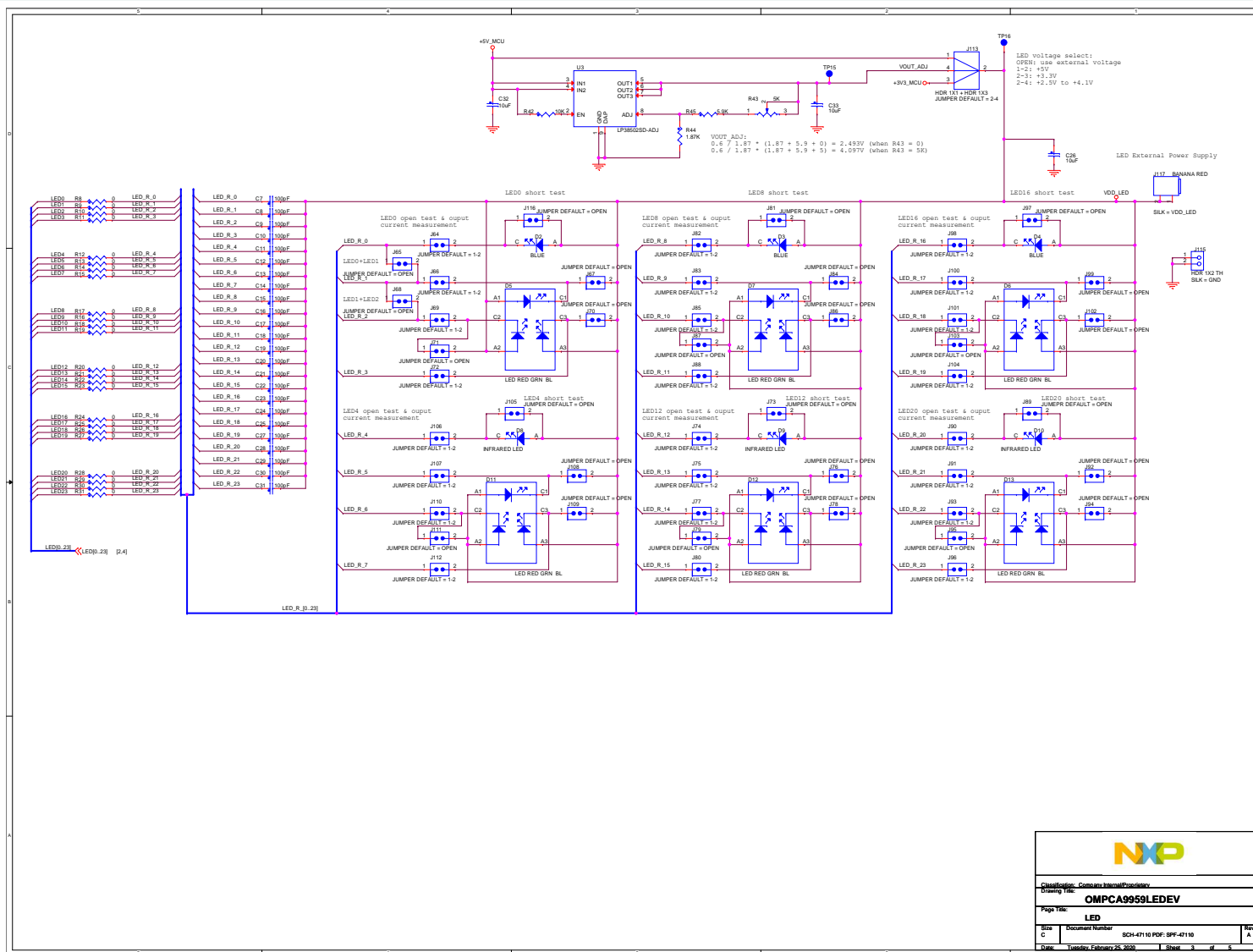

Figure 6. LED portion schematic

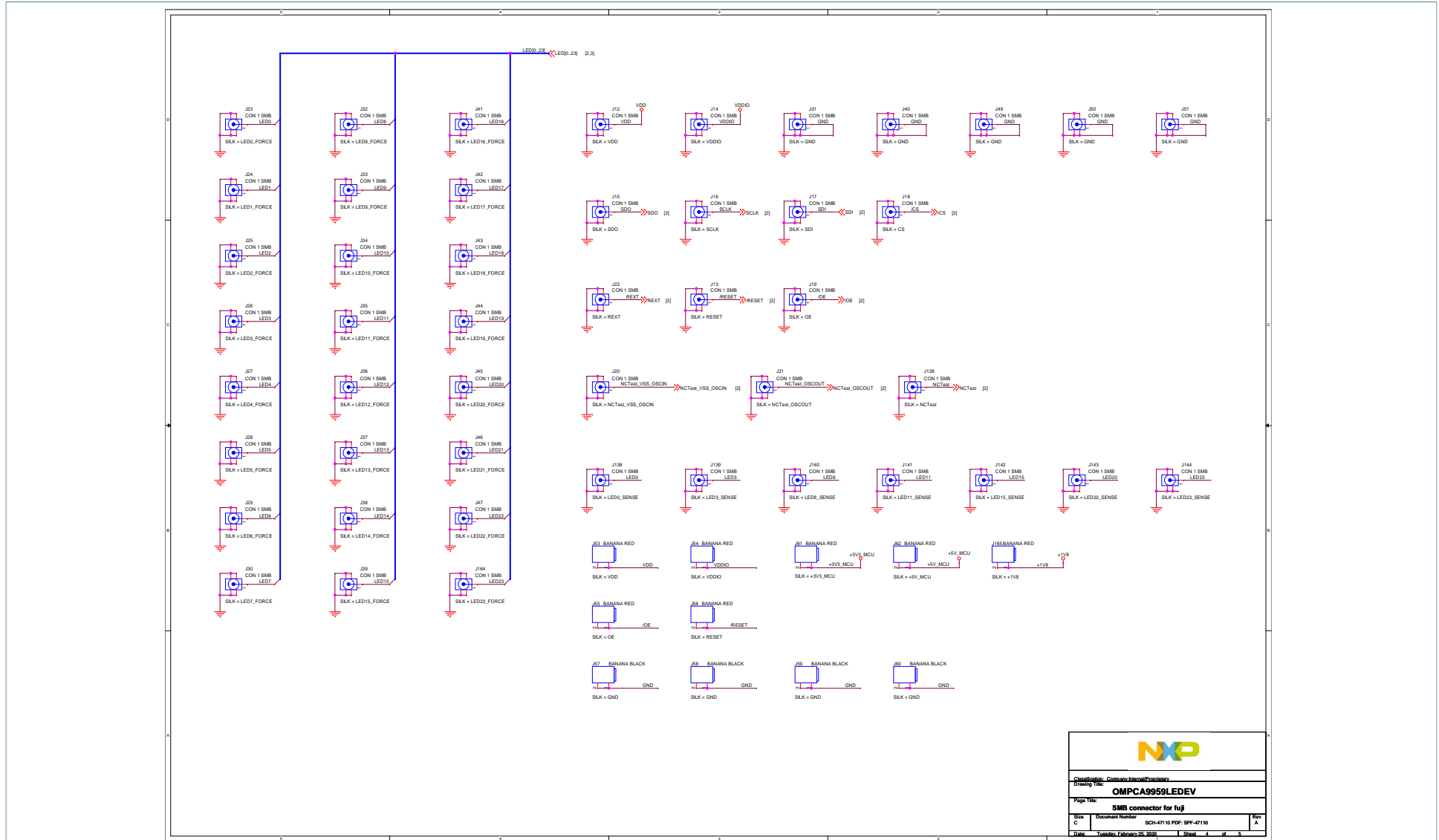
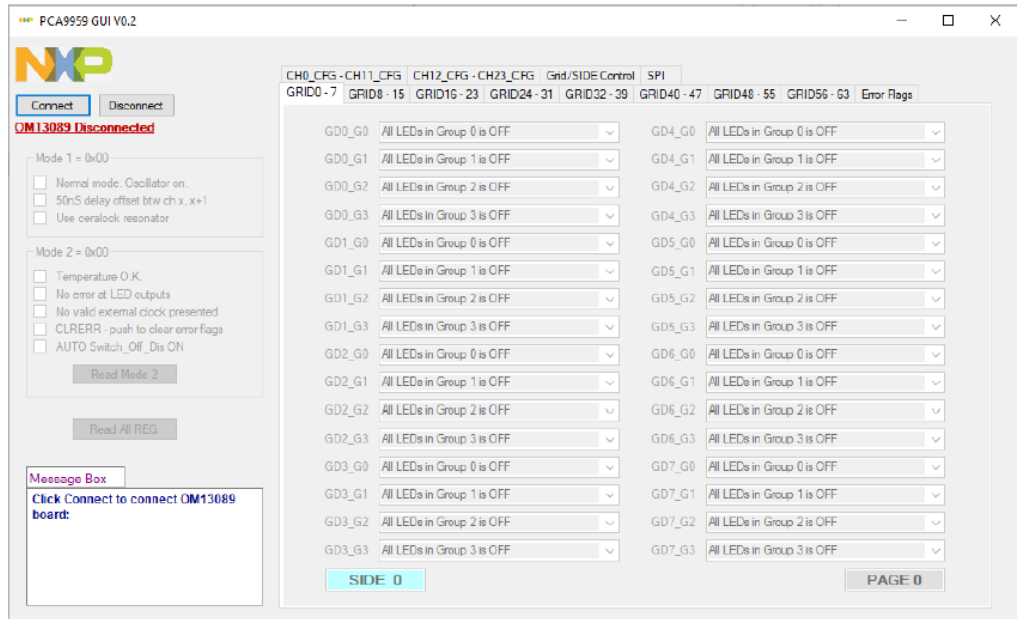

Figure 7. SMB and banana connector portion schematic

7 PCA9959 demo GUI

7.1 Run PCA9959 GUI V0.1.exe on Windows 7, 8, or 10 PC

1. Click “Connect” button to connect OM13089 board



2. If OM13089 board is detected
 - a. It shows “OM13089 board connected” in Message Box
 - b. It shows GUI version number as well as reads out firmware version number in the OM13089 board

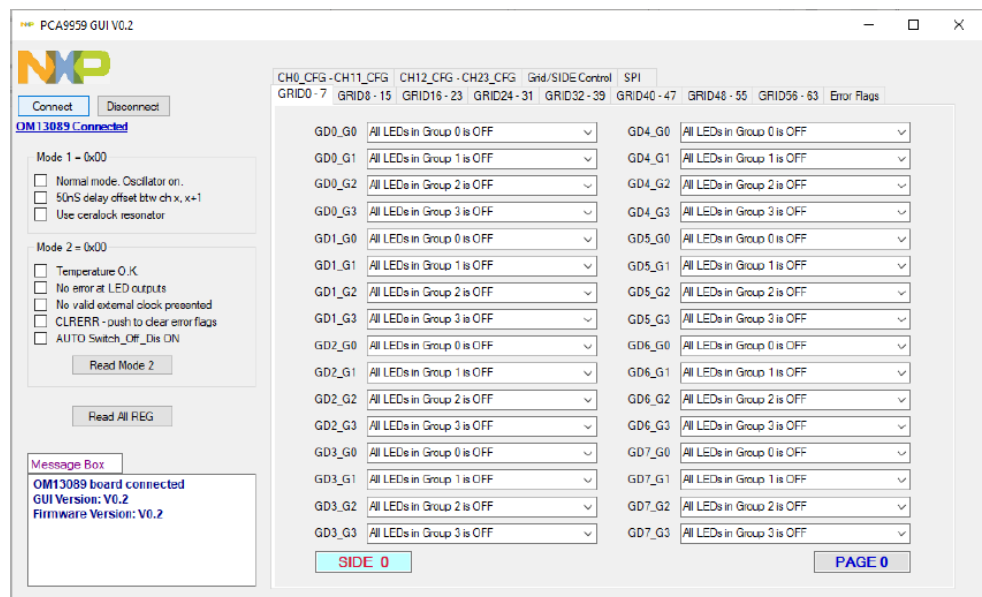

3. If OM13089 board is not detected
 - a. It shows “OM13089 (LPC 54114) board doesn't find!” in Message Box.
 - b. Please check whether USB cable is connected to right USB port (J5) on OM13089 board

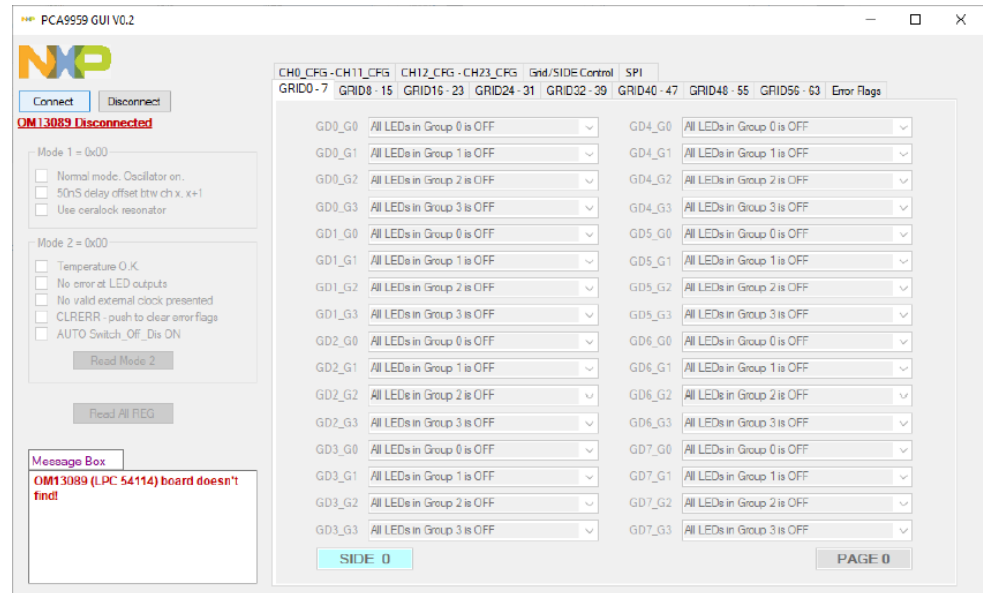

4. Use Mode1 & 2 command interface to read/write Mode1 & 2 register
 - a. It shows MOSI and MISO value in Message Box

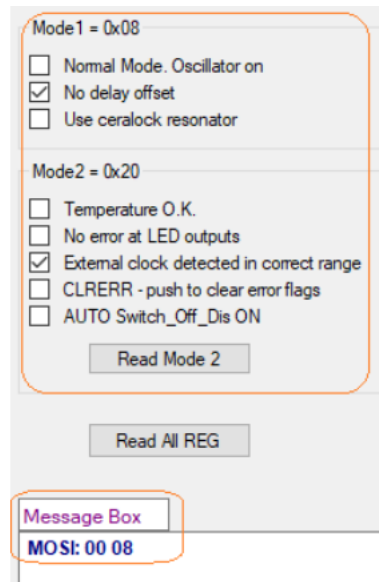

5. “Write All REG” and “Read All REG” buttons
 - a. Use “Read All REG” button to read our all register value from PCA9959
 - b. Open “Read All REG.txt” to see all PCA9959 registers value

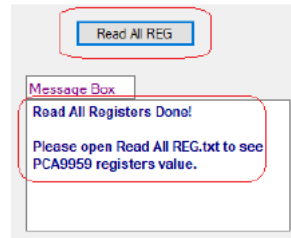

6. Use “GRID0-7” to “GRID56-63” to adjust GRID0 – GRID63 setting
 - a. Use GRID0 – GRID63 Combo Box to adjust GRIDx value

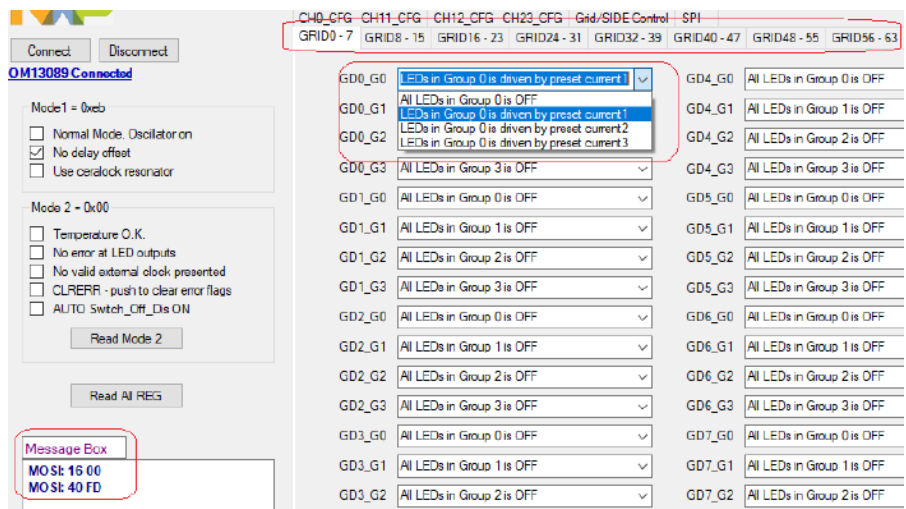

7. Use “CH0_CFG-CH11_CFG” and “CH12_CFG-CH23_CFG” LED CHx output
 - a. Use CHx checkbox to enable or disable LED CHx output
 - b. Use CHx Group Combo Box to select LED CHx group.
 - c. Use CHx Current Setx to set chrrnt set 1-3 for LED CHx.

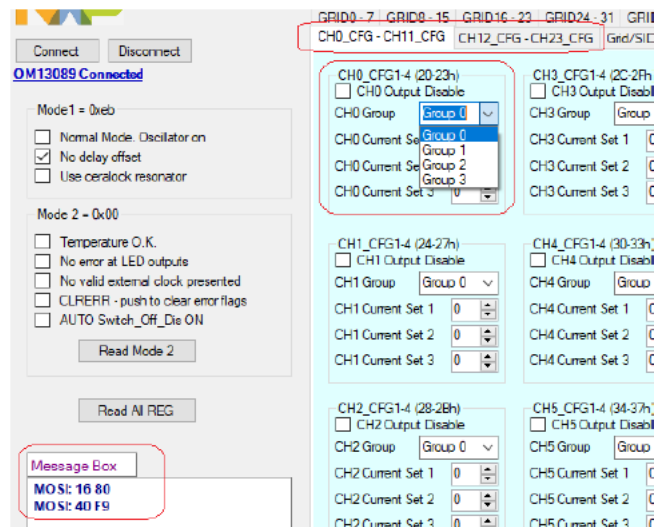

8. Use “Error Flags” page to read out error status for LEDs output
 - a. Click on “Read Error Flags” button to read out error status for LED0-23 output
 - b. Click on “CLRERR” button to clear error flags.

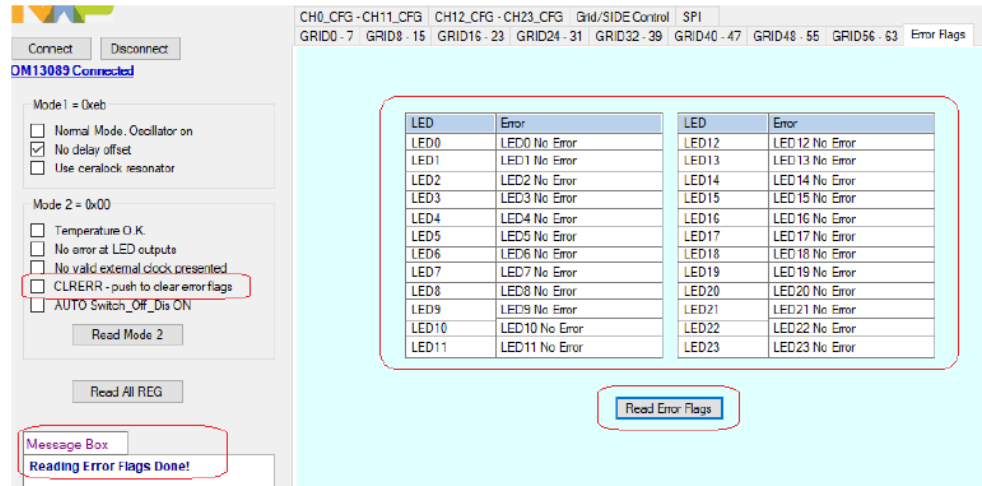

9. Use “Grid/SID Control” page to select below settings
 - a. Time Step, Duration Counter, Gradation start/stop, One short/Recurrence mode and SIDE mode settings

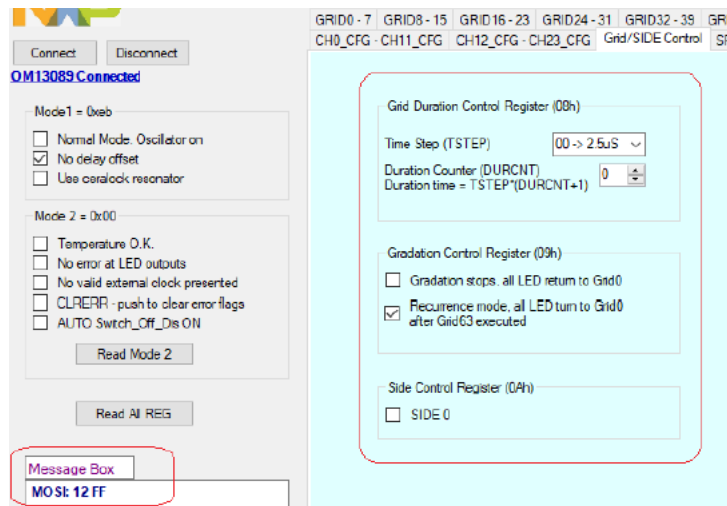

10. Use “SPI” page to select SPI interface related settings
 - a. SPI speed, Pre-Delay, Post-Delay, Frame Delay, Transfer Delay and command interface

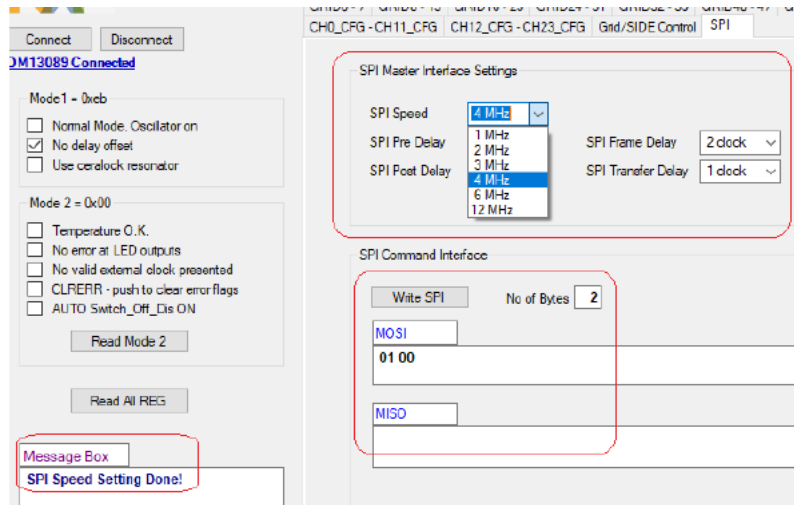

8 Abbreviations

Table 7. Abbreviations

Acronym	Description
ESD	Electro Static Discharge
GUI	Graphical User Interface
I ² C-bus	Inter-integrated Circuit bus
IC	Integrated Circuit
LED	Light Emitting Diode
MISO	Master In, Slave Out
MOSI	Master Out, Slave In
PC	Personal Computer
PWM	Pulse Width Modulator
RAM	Random Access Memory
RGB	Red/Green/Blue
RGBA	Red/Green/Blue/Amber
SPI	Serial Peripheral Interface
USB	Universal Serial Bus

9 References

- [1] **PCA9959** — 24-channel SPI serial bus 32 mA / 5.5V constant current LED driver; Product data sheet; NXP Semiconductors

10 Legal information

10.1 Definitions

Draft — The document is a draft version only. The content is still under internal review and subject to formal approval, which may result in modifications or additions. NXP Semiconductors does not give any representations or warranties as to the accuracy or completeness of information included herein and shall have no liability for the consequences of use of such information.

10.2 Disclaimers

Limited warranty and liability — Information in this document is believed to be accurate and reliable. However, NXP Semiconductors does not give any representations or warranties, expressed or implied, as to the accuracy or completeness of such information and shall have no liability for the consequences of use of such information. NXP Semiconductors takes no responsibility for the content in this document if provided by an information source outside of NXP Semiconductors. In no event shall NXP Semiconductors be liable for any indirect, incidental, punitive, special or consequential damages (including - without limitation - lost profits, lost savings, business interruption, costs related to the removal or replacement of any products or rework charges) whether or not such damages are based on tort (including negligence), warranty, breach of contract or any other legal theory. Notwithstanding any damages that customer might incur for any reason whatsoever, NXP Semiconductors' aggregate and cumulative liability towards customer for the products described herein shall be limited in accordance with the Terms and conditions of commercial sale of NXP Semiconductors.

Right to make changes — NXP Semiconductors reserves the right to make changes to information published in this document, including without limitation specifications and product descriptions, at any time and without notice. This document supersedes and replaces all information supplied prior to the publication hereof.

Suitability for use — NXP Semiconductors products are not designed, authorized or warranted to be suitable for use in life support, life-critical or safety-critical systems or equipment, nor in applications where failure or malfunction of an NXP Semiconductors product can reasonably be expected to result in personal injury, death or severe property or environmental damage. NXP Semiconductors and its suppliers accept no liability for inclusion and/or use of NXP Semiconductors products in such equipment or applications and therefore such inclusion and/or use is at the customer's own risk.

Applications — Applications that are described herein for any of these products are for illustrative purposes only. NXP Semiconductors makes no representation or warranty that such applications will be suitable for the specified use without further testing or modification. Customers are responsible for the design and operation of their applications and

products using NXP Semiconductors products, and NXP Semiconductors accepts no liability for any assistance with applications or customer product design. It is customer's sole responsibility to determine whether the NXP Semiconductors product is suitable and fit for the customer's applications and products planned, as well as for the planned application and use of customer's third party customer(s). Customers should provide appropriate design and operating safeguards to minimize the risks associated with their applications and products. NXP Semiconductors does not accept any liability related to any default, damage, costs or problem which is based on any weakness or default in the customer's applications or products, or the application or use by customer's third party customer(s). Customer is responsible for doing all necessary testing for the customer's applications and products using NXP Semiconductors products in order to avoid a default of the applications and the products or of the application or use by customer's third party customer(s). NXP does not accept any liability in this respect.

Export control — This document as well as the item(s) described herein may be subject to export control regulations. Export might require a prior authorization from competent authorities.

Evaluation products — This product is provided on an "as is" and "with all faults" basis for evaluation purposes only. NXP Semiconductors, its affiliates and their suppliers expressly disclaim all warranties, whether express, implied or statutory, including but not limited to the implied warranties of non-infringement, merchantability and fitness for a particular purpose. The entire risk as to the quality, or arising out of the use or performance, of this product remains with customer. In no event shall NXP Semiconductors, its affiliates or their suppliers be liable to customer for any special, indirect, consequential, punitive or incidental damages (including without limitation damages for loss of business, business interruption, loss of use, loss of data or information, and the like) arising out of the use of or inability to use the product, whether or not based on tort (including negligence), strict liability, breach of contract, breach of warranty or any other theory, even if advised of the possibility of such damages. Notwithstanding any damages that customer might incur for any reason whatsoever (including without limitation, all damages referenced above and all direct or general damages), the entire liability of NXP Semiconductors, its affiliates and their suppliers and customer's exclusive remedy for all of the foregoing shall be limited to actual damages incurred by customer based on reasonable reliance up to the greater of the amount actually paid by customer for the product or five dollars (US\$5.00). The foregoing limitations, exclusions and disclaimers shall apply to the maximum extent permitted by applicable law, even if any remedy fails of its essential purpose.

Translations — A non-English (translated) version of a document is for reference only. The English version shall prevail in case of any discrepancy between the translated and English versions.

10.3 Trademarks

Notice: All referenced brands, product names, service names and trademarks are the property of their respective owners.

Tables

Tab. 1.	OMPCA9959LEDEV EV board main components	8	Tab. 4.	Jumper settings for LEDs	9
Tab. 2.	Jumper settings for power supply	8	Tab. 5.	Jumper settings for SMB connectors	10
Tab. 3.	Jumper settings Host interface	8	Tab. 6.	Jumper settings for banana connectors	10
			Tab. 7.	Abbreviations	20

Figures

Fig. 1.	OMPCA9959LEDEV evaluation board	6	Fig. 5.	PCA9959 schematic	12
Fig. 2.	OM13089 MCU board	7	Fig. 6.	LED portion schematic	13
Fig. 3.	OMPCA9959LEDEV evaluation board	7	Fig. 7.	SMB and banana connector portion	
Fig. 4.	Jumpers and test points location	11		schematic	14

Contents

1 Introduction 3

2 Features 4

3 Getting started 5

3.1 Assumptions 5

3.2 Static handling requirements 5

3.3 Minimum system requirements 5

3.4 Power requirements 5

4 Hardware installation 6

4.1 OMPCA9959LEDEV EV board and
OM13089 MCU board connection 6

5 Hardware description 8

6 Schematic 12

7 PCA9959 demo GUI 15

7.1 Run PCA9959 GUI V0.1.exe on Windows 7,
8, or 10 PC 15

8 Abbreviations 20

9 References 21

10 Legal information 22

Please be aware that important notices concerning this document and the product(s) described herein, have been included in section 'Legal information'.

© NXP B.V. 2020.

All rights reserved.

For more information, please visit: <http://www.nxp.com>

For sales office addresses, please send an email to: salesaddresses@nxp.com

Date of release: 27 April 2020
Document identifier: UM11436