



TWR-SENSOR-PAK

User's Manual

Rev. 1.1

Contents

1 Overview	3
2 Reference Documents.....	5
3 Hardware Features.....	6
3.1 TWR-SENSOR	6
3.1.1 MCU	7
3.1.2 OSBDM / Virtual Serial	7
3.1.3 Communication with the Tower System	8
3.1.4 Sensor Identification.....	9
3.1.5 TWRPI Sockets	10
3.1.6 Additional Sensors.....	13
3.1.7 User Feedback	15
3.2 TWRPI-MMA7660	15
3.3 TWRPI-MPL115A.....	16
3.4 TWRPI-MPR121	17
3.5 TWRPI-TSS	17
3.6 TWRPI-KEYPAD	18
3.7 Elevator Connections	18
4 Jumper Table	21
5 Mechanical Form Factor	22

1 Overview

The TWR-SENSOR-PAK is a module in the Tower System that features swappable sensor modules, or plug-ins. These swappable plug-ins allow you to rapidly evaluate and compare an expanding portfolio of sensors. Using real-time sensor data and interaction with your environment, it's easy to sense your world with the TWR-SENSOR-PAK.

The TWR-SENSOR-PAK includes the following Tower Plug-ins (TWRPI's) that feature Freescale Sensors:

- TWRPI-MMA7660, featuring the MMA7660FC Digital Accelerometer
- TWRPI-MPL115A, featuring the MPL115A Digital Miniature Barometer
- TWRPI-MPR121, featuring the MPR121 Proximity Capacitive Touch sensor

The TWR-SENSOR-PAK also features the TWRPI-TSS plug-in, which enables the use of the Freescale Touch Sensing Software Suite (TSS).

The TWR-SENSOR is the base Tower module. The TWR-SENSOR module utilizes the MC9S08QE96 MCU to interface directly to the sensors and to communicate with the Freescale Tower System as either a slave MCU of a master MCU, with limited capabilities. The TWR-SENSOR also utilizes the MC9S08JM60 MCU. This MCU is used to provide serial communication over USB and provide Open Source BDM functionality to the MC9S08QE. The TWR-SENSOR module features two general purpose sockets that can be interchangeable populated with the included accelerometer and barometer plug-ins and will be utilized by the majority of future TWRPI's. This general purpose plug-in socket can utilize I2C, SPI, analog signals, and GPIO's to interface the plug-in's featured device with the MC9S08QE. Additionally there are two sockets dedicated to capacitive touch capabilities. One socket is utilized by the actual touch sensing device; the second socket is used to provide access to the capacitive electrodes.

The TWR-SENSOR module includes the following on-board sensors:

- Freescale MPR03X Capacitive Touch Controller (with dedicated touch pads)
- Sensirion SHT21 Digital Humidity and Temperature Sensor
- Intersil ISL29011 Ambient Light Sensor with Proximity Detection
- Vishay TSOP36236 36kHz IR Receiver Module

All sensors (on-board and plug-ins) are designed to interface directly with the on-board MC9S08QE. The TWR-SENSOR MC9S08QE has full access to all sensors, including I2C, SPI, analog, and GPIOs used on the TWRPI sockets. Sensors that utilize I2C and/or analog signals (general purpose sockets only) can also interface directly to an additional Tower System MCU via the Tower System Elevator.

A block diagram for the TWR-SENSOR is shown in the figure below.

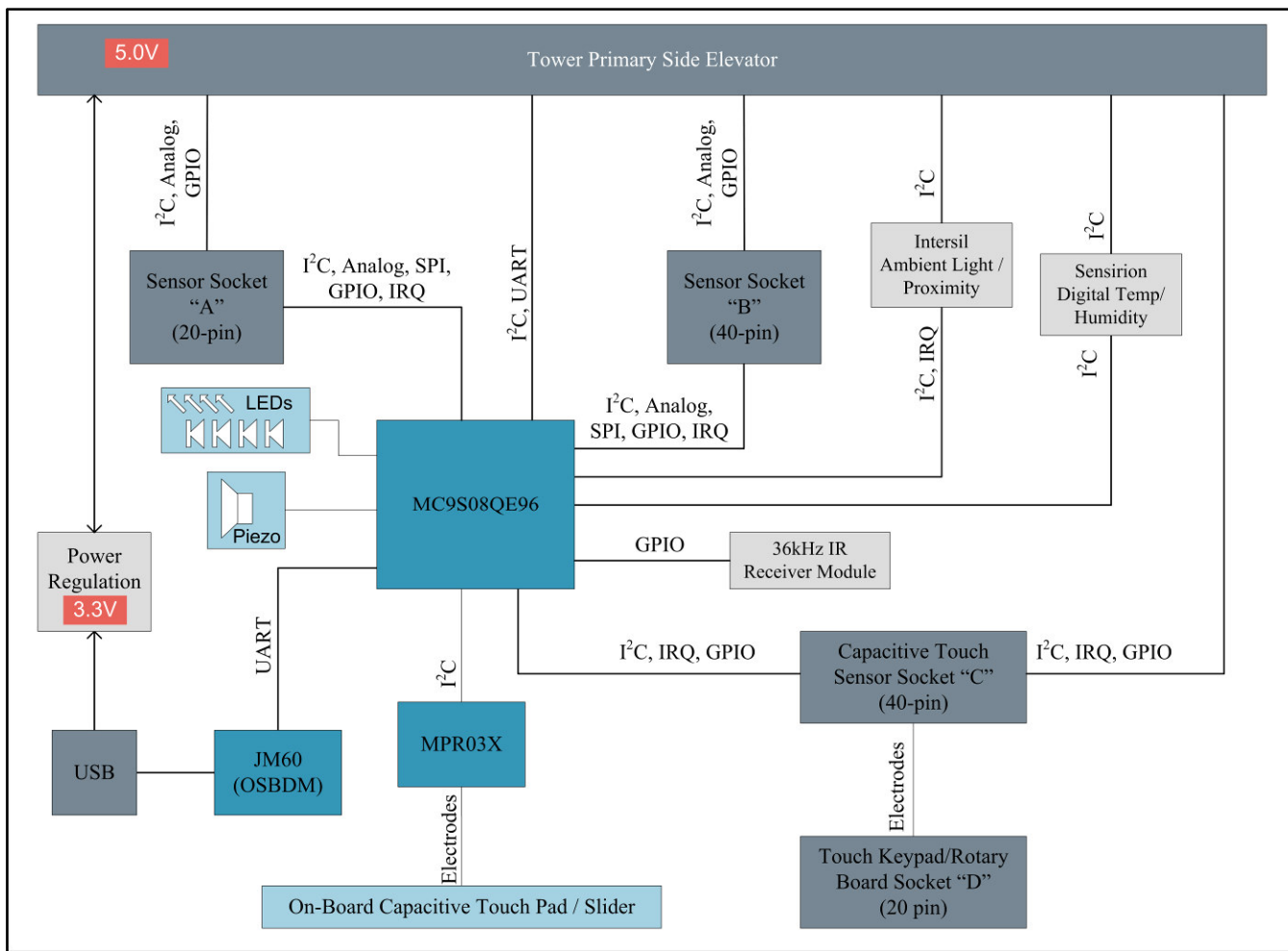

External Connectors
 Interface Component
 Freescale Device
 3rd Party Device
 Power

Figure 1 - TWR-SENSOR Block Diagram

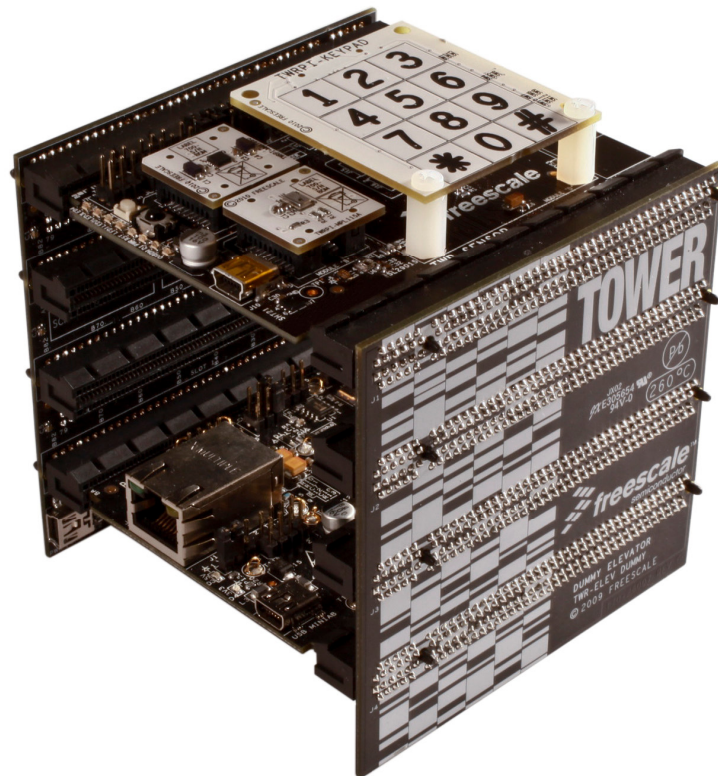

Figure 2 - Tower System with TWR-SENSOR-PAK

2 Reference Documents

The documents listed below should be referenced for more information on the Freescale Tower system and the TWR-SENSOR-PAK. Refer to <http://www.freescale.com/tower> for the latest revision of all Tower documentation.

- *TWR-SENSOR-PAK Schematics*
- *TWR-SENSOR-PAK Quick Start Guide*
- *Freescale Tower Electromechanical Specification*
- *Freescale MMA7660 Data Sheet*
- *Freescale MPL115A Data Sheet*
- *Freescale MPR121 Data Sheet*
- *Freescale MPR03X Data Sheet*
- *Freescale TSS Users Guide*
- *Sensirion SHT21 Data Sheet*
- *Intersil ISL29011 Data Sheet*
- *Vishay TSOP36236 Data Sheet*

3 Hardware Features

This section provides more details about the features and functionality of the TWR-SENSOR-PAK. The TWR-SENSOR-PAK is comprised of the following modules:

- **TWR-SENSOR** – the base Tower System module with sockets capable of accepting Tower Plug-ins (TWRPI's)
- **TWRPI-MMA7660** – Tower Plug-in featuring the Freescale MMA7660FC Digital Accelerometer
- **TWRPI-MPL115A** – Tower Plug-in featuring the Freescale MPL115A2 Digital Miniature Barometer
- **TWRPI-MPR121** – Tower Plug-in featuring the Freescale MPR121 Proximity Capacitive Touch Controller
- **TWRPI-TSS** – Tower Plug-in that enables the use of the Freescale Touch Sensing Software Suite on the MC9S08QE MCU.
- **TWRPI-KEYPAD** – Tower Plug-in that implements a basic 12-key touch interface.

The TWR-SENSOR-PAK provides an initial selection of Tower System Plug-ins featuring a wide variety of Freescale sensors. The TWR-SENSOR module can be expanded with additional Tower Plug-in to rapidly evaluate additional sensors and devices.

The TWR-SENSOR-PAK can be used in several modes:

- **Stand-alone Mode** – In this mode the on-board MC9S08QE MCU collects data from the sensors and can provide feedback to the user either by the on-board LEDs, piezo buzzer, or to a PC host via USB.
- **Tower MCU Mode** – In this mode the TWR-SENSOR-PAK acts as the primary MCU in the Tower System. This mode is similar to the stand-alone operation, but the functionality of the TWR-SENSOR-PAK can be expanded to a number of Tower System peripheral modules. Interaction to additional Tower System Modules is limited to I2C and UART only.
- **Tower Peripheral Mode** – In this mode the TWR-SENSOR-PAK acts as a peripheral device in the Tower System. The primary Tower System MCU can interact with the TWR-SENSOR MC9S08QE MCU, which acts as a sensor data aggregator, or the Tower System MCU can access the sensors directly (limited to I2C or analog).

3.1 TWR-SENSOR

The TWR-SENSOR is the base Tower System module. This module features two sockets capable of receiving Tower System Plug-ins. Additionally, the TWR-SENSOR features two additional sockets that are dedicated to capacitive touch solutions.

The TWR-SENSOR module provides a development platform to rapidly evaluate and integrate sensors.

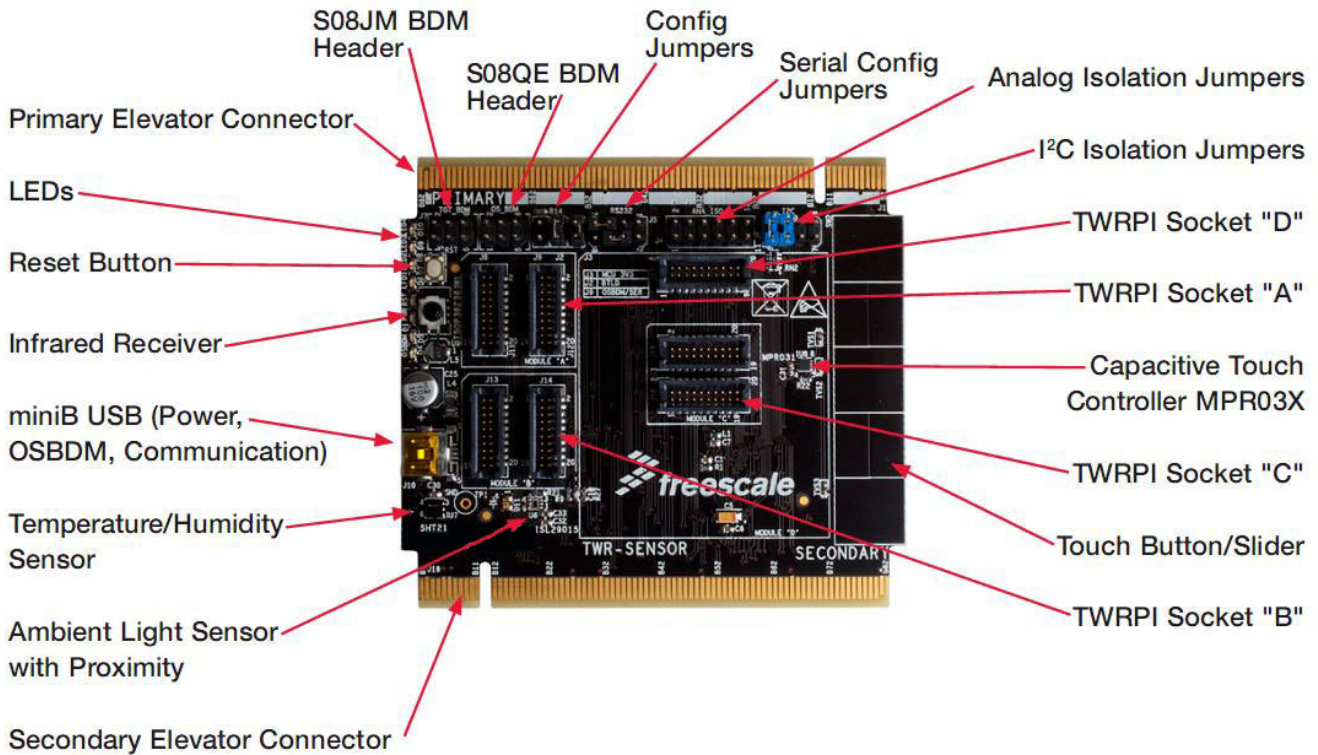

Figure 3 - TWR-SENSOR Module

3.1.1 MCU

The TWR-SENSOR module features the MC9S08QE96 MCU. The purpose of this controller is to provide full interaction with the various sensors and devices. The MC9S08QE has full access to all on-board sensors and has expanded access to the TWRPI sockets (I2C, SPI, IRQ, Timers, GPIO, Sensor Identification Signals, and Analog Signals).

3.1.2 OSBDM / Virtual Serial

The TWR-SENSOR features a secondary microcontroller. The on-board MC9S08JM60 enables Open Source BDM capabilities to provide programmability and run-time control/debug of the MC9S08QE.

The MC9S08JM also implements a virtual serial communication device over the TWR-SENSOR miniB USB connection. With the included Freescale CDC Device driver, the TWR-SENSOR module can provide sensor data to a host PC as a standalone module. This method is used in the “out of box” demonstration to interface with the FreeMASTER application.

Use Jumper J9 to select between Serial Communication and OSBDM. Refer to the Jumper Table section for additional configuration details.

3.1.3 Communication with the Tower System

The TWR-SENSOR module is capable of interacting with the full Tower System as either a MCU module or a peripheral module.

As a Tower System MCU, the TWR-SENSOR module can utilize I2C and/or UART to communicate with additional Tower System peripheral modules.

The TWR-SENSOR has access to either the Tower Elevator I2C_0 (SCL0 / SDA0) or I2C_1 (SCL1 / SDA1). Which I2C interface is used is configurable using Jumper J6.

The TWR-SENSOR MC9S08QE is accessible from either the Tower Elevator UART_0 signals or the Tower Elevator UART_1 signals. For this slave mode of operation the RX and TX lines are crossed. The selection of which UART to used and to configure the correct crossing of the RX and TX is configurable via Jumper J5 (Serial CFG).

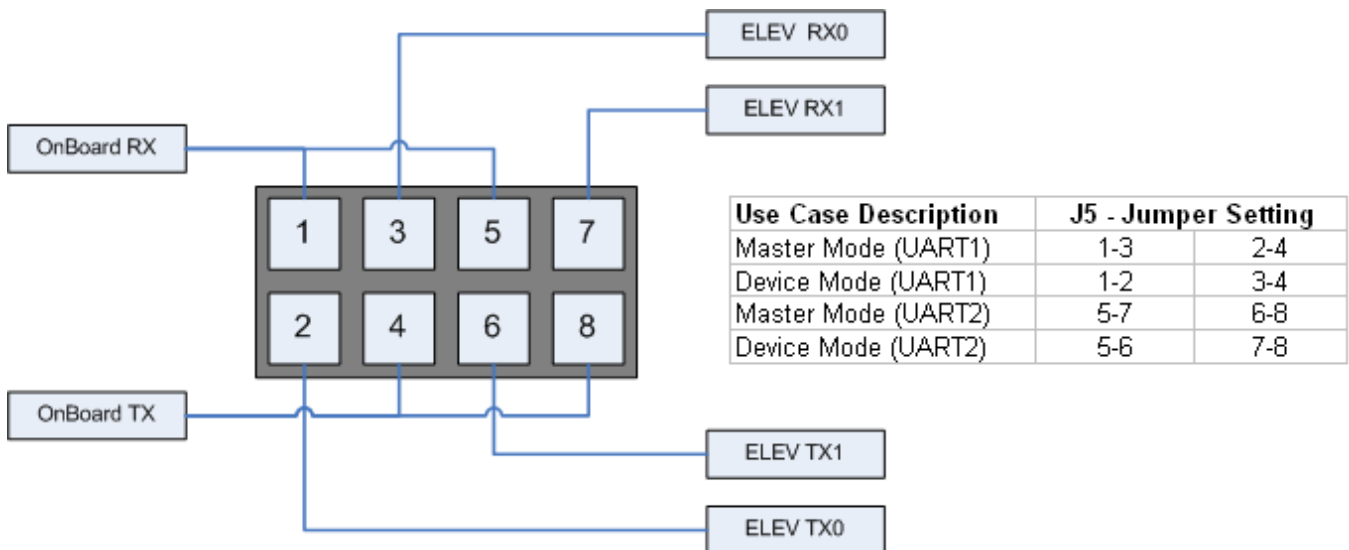

Figure 4 - TWR-SENSOR UART Configuration Jumper

As a Tower System Peripheral, the Tower System MCU also has direct access to compatible sensors and plug-ins. The direct access to the TWR-SENSOR components can use the Tower Elevator I2C_0 (SCL0 / SDA0) signals or I2C_1 (SCL1 / SDA1) signals and the analog signals that are utilized on the general purpose TWRPI sockets (“A” and “B”). These signals are isolated from the Tower Elevator by default to provide maximum flexibility with additional Tower System modules and must be connected using the appropriate I2C_EN and ANA_EN jumpers. Refer to the Jumper Table section for additional configuration details.

- To enable access to the Sensors using the I2C_1 signals Pins 1-2 & 5-6 of J6 must be shunted.
- To enable access to the Sensors using the I2C_0 signals Pins 3-4 & 7-8 of J6 must be shunted.
- To enable access to the MCU using the I2C_1 signals Pins 1-3 & 5-7 of J6 must be shunted.

- To enable access to the MCU using the I2C_0 signals Pins 2-4 & 6-8 of J6 must be shunted.

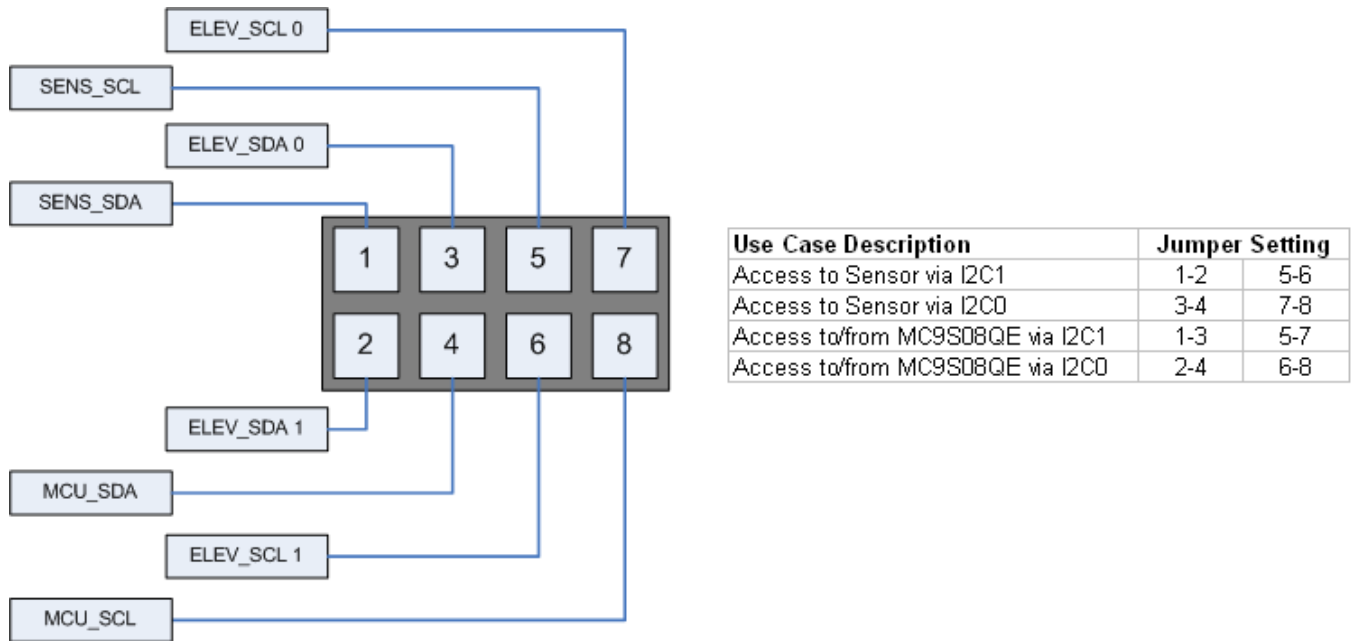

Figure 5 - TWR-SENSOR I2C Configuration Jumper

3.1.4 Sensor Identification

Each TWRPI Socket on the TWR-SENSOR module provides two signals to the TWR-SENSOR MC9S08QE that are used for TWRPI identification. Each TWRPI module is required to place one of eight select resistances on each signal. The TWR-SENSOR module uses the resistance on the signal to create a voltage divider and the TWR-SENSOR MC9S08QE will use an ADC input to determine the voltage level and identify the installed TWRPI.

The following table describes the possible resistive levels and there corresponding voltage levels:

Table 1 - TWRPI Identification Resistors

Resistor (kΩ)	Voltage Level (V)	Percentage (%)
0 (GND)	0.00	0
1.3	0.38	12.5
3.3	0.82	25
5.6	1.18	37.5
10	1.65	50
18	2.12	62.5
30	2.48	75
62	2.84	87.5
∞ (NC)	3.30	100

The TWRPI's included in the TWR-SENSOR-PAK are identified using the following TWRPI ID's:

Table 2 - TWR-SENSOR-PAK TWRPI ID's

TWRPI	ID0 (%)	ID1 (%)
TWRPI-MMA7660	0	100
TWRPI-MPL115A	87.5	100
TWRPI-MPR121	75	100
TWRPI-TSS	75	0
TWRPI-KEYPAD	62.5	100

3.1.5 TWRPI Sockets

The TWR-SENSOR module features four sockets that can accept a variety of different Tower Plug-in modules, referred to as TWRPI's.

The TWR-SENSOR provides 5V, 3.3V, 3.3VDDA, GND, and VSS to all TWRPI sockets. If a particular TWRPI device requires a different voltage the regulation will need to be done on the TWRPI.

Sockets "A" and "B" are interchangeable general purpose sockets that provide access to I2C, SPI, IRQs, GPIOs, Timers, Analog signals, TWRPI ID signals, reset, and voltage signals.

The pinout for Socket "A" and "B" is defined as:

Table 3 - Socket "A" & "B" Pin Description

Left-side 2x10 Connector (J11/J13) Right-side 2x10 Connector (J12/J14)

Pin	Description
1	5V VCC
2	3.3 V VCC
3	GND
4	3.3V VDDA
5	VSS (Analog GND)
6	VSS (Analog GND)
7	VSS (Analog GND)
8	ADC: Analog 0
9	ADC: Analog 1
10	VSS (Analog GND)
11	VSS (Analog GND)
12	ADC: Analog 2
13	VSS (Analog GND)
14	VSS (Analog GND)
15	GND
16	GND
17	ADC: TWRPI ID 0
18	ADC: TWRPI ID 1
19	GND
20	Reset

Pin	Description
1	GND
2	GND
3	I2C: SCL
4	I2C: SDA
5	GND
6	GND
7	GND
8	GND
9	SPI: MISO
10	SPI: MOSI
11	SPI: SS
12	SPI: CLK
13	GND
14	GND
15	GPIO: GPIO0/IRQ
16	GPIO: GPIO1/IRQ
17	GPIO: GPIO2
18	GPIO: GPIO3
19	GPIO: GPIO4/Timer
20	GPIO: GPIO5/Timer

Sockets "C" and "D" are dedicated to capacitive touch sensing solutions. Socket "C" is exclusive for the touch sensing controller and Socket "D" provides access to the capacitive electrodes.

Socket "C" provides access to Electrodes from Socket "D", I2C, IRQ, GPIOs, TWRPI ID Signals, Electrode signals out to the MCU, reset, and voltage signals.

The pinout for Socket “C” is defined as:

Table 4 - Socket "C" Pin Description

Upper 2x10 Connector (J15)		Lower 2x10 Connector (J16)	
Pin	Description	Pin	Description
1	5V VCC	1	GND
2	3.3 V VCC	2	GND
3	Socket D: Electrode In 0	3	I2C: SCL
4	3.3V VDDA	4	I2C: SDA
5	Socket D: Electrode In 1	5	GPIO: Electrode Out 0
6	VSS (Analog GND)	6	GPIO: Electrode Out 1
7	Socket D: Electrode In 2	7	GPIO: Electrode Out 2
8	Socket D: Electrode In 3	8	GPIO: Electrode Out 3
9	Socket D: Electrode In 4	9	GPIO: Electrode Out 4
10	Socket D: Electrode In 5	10	GPIO: Electrode Out 5
11	Socket D: Electrode In 6	11	GPIO: Electrode Out 6
12	Socket D: Electrode In 7	12	GPIO: Electrode Out 7
13	Socket D: Electrode In 8	13	GPIO: Electrode Out 8
14	Socket D: Electrode In 9	14	GPIO: Electrode Out 9
15	Socket D: Electrode In 10	15	GPIO: Electrode Out 10
16	Socket D: Electrode In 11	16	GPIO: Electrode Out 11
17	ADC: TWRPI ID 0	17	GPIO: GPIO0/IRQ
18	ADC: TWRPI ID 1	18	GPIO: GPIO1
19	GND	19	GPIO: GPIO2
20	Reset	20	GND

Socket “D” provides access to the Electrodes on Socket “D”, TWRPI ID Signals, reset, and voltage signals.

The pinout for Socket “D” is defined as:

Table 5 - Socket "D" Pin Description
2x10 Connector (J17)

Pin	Description
1	5V VCC
2	3.3 V VCC
3	Socket D: Electrode 0
4	3.3V VDDA
5	Socket D: Electrode 1
6	VSS (Analog GND)
7	Socket D: Electrode 2
8	Socket D: Electrode 3
9	Socket D: Electrode 4
10	Socket D: Electrode 5
11	Socket D: Electrode 6
12	Socket D: Electrode 7
13	Socket D: Electrode 8
14	Socket D: Electrode 9
15	Socket D: Electrode 10
16	Socket D: Electrode 11
17	ADC: TWRPI ID 0
18	ADC: TWRPI ID 1
19	GND
20	Reset

3.1.6 Additional Sensors

In addition to the swappable sensors included with the TWR-SENSOR-PAK, the TWR-SENSOR included the following sensors and components:

- Freescale MPR03X Capacitive Touch Controller (with dedicated touch pads)
- Sensirion SHT21 Digital Humidity and Temperature Sensor
- Intersil ISL29011 Ambient Light Sensor with Proximity Detection
- Vishay TSOP36236 36kHz IR Receiver Module

3.1.6.1 Freescale MPR03X Capacitive Touch Controller

The TWR-SENSOR features the Freescale MPR03X Proximity Capacitive Touch Sensor Controller. The MPR03X is an I2C driven Capacitive Touch Sensor Controller, optimized to manage two electrodes with interrupt functionality, or three electrodes with the interrupt disabled.

The TWR-SENSOR uses the MPR03X as a three electrode controller. The three electrodes are multiplexed onto five dedicated touch pads located on the TWR-SENSOR module. The TWR-SENSOR MC9S08QE is responsible for decoding which of the five touch regions are selected.

The five touch regions can function on the TWR-SENSOR module as either three isolated discrete touch regions, five discrete touch regions using multiplexing, or as a touch slider.

The TWR-SENSOR uses the MPR031 version and is accessible to the TWR-SENSOR MC9S08QE and the Tower Elevator (SDA1/SCL1) via I2C at address '1001'010'. For additional information regarding the MPR031 refer to the MPR03X Data Sheet.

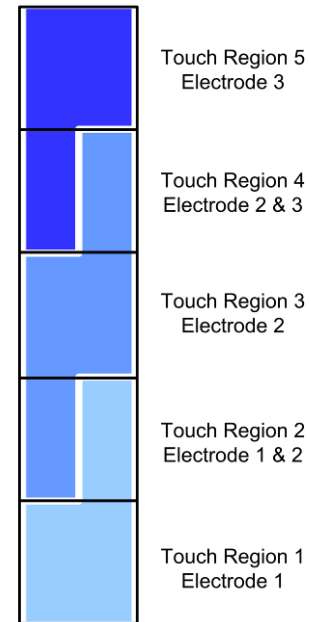

Figure 6 - MPR03X Electrodes / Touch Regions

3.1.6.2 Sensirion SHT21 Digital Humidity and Temperature Sensor

The TWR-SENSOR features a miniature digital humidity sensor with integrated temperature sensor. The Sensirion SHT21 is accessible to the TWR-SENSOR MC9S08QE and the Tower Elevator (SDA1/SCL1) via I2C at address '1000'000'. Refer to the SHT21 data sheet for additional information. Additionally refer to the SHT21 Humidity Formula application note for specific formulas related to calculating the relative humidity.

3.1.6.3 Intersil ISL29011 Ambient Light Sensor with Proximity Detection

The TWR-SENSOR features a digital ambient light sensor with integrated proximity sensor. The Intersil ISL29011 is accessible to the TWR-SENSOR MC9S08QE and the Tower Elevator (SDA1/SCL1) via I2C at address '1000'100'. The ISL29011 also utilizes an interrupt pin, but is only accessible by the TWR-SENSOR MC9S08QE. Refer to the ISL29011 data sheet for additional information.

3.1.6.4 Vishay TSOP36236 36kHz IR Receiver Module

The TWR-SENSOR features a 36kHz infrared control receiver module capable of receiving remote control code, such as RC-5 and RC-6. The Vishay TSOP36236 IR receiver module provides a dedicated output signal directly to the TWR-SENSOR MC9S08QE (PTC4). The IR receiver data is not accessible directly to the Tower Elevator. Refer to the TSOP362 data sheet for additional information.

3.1.7 User Feedback

The TWR-SENSOR features a series of LEDs and a Piezo buzzer to provide visual and audible feedback. These feedback components are directly accessible only to the TWR-SENSOR MC9S08QE.

The components are accessible on the following pins:

Table 6 - Feedback Pins/Usage

Feedback Component	MC9S08QE Pin	Usage
LED1 (Green)	PTE4	Drive signal HIGH to turn LED "ON"
LED2 (Orange)	PTE5	Drive signal HIGH to turn LED "ON"
LED3 (Red)	PTE6	Drive signal HIGH to turn LED "ON"
LED4 (Yellow)	PTE7	Drive signal HIGH to turn LED "ON"
Piezo Buzzer	PTA7/TPM2CH2	Use the PWM feature to generate an audible tone.

3.2 TWRPI-MMA7660

The TWR-SENSOR-PAK includes the TWRPI-MMA7660. The TWRPI-MMA7660 is a Tower Plug-in that features the Freescale MMA7660FC digital accelerometer. The TWRPI-MMA7660 can be inserted into either Socket "A" or Socket "B" on the TWR-SENSOR module.



Figure 7 - TWRPI-MMA7660

The MMA7660FC is a ± 1.5 g 3-Axis Accelerometer with Digital Output (I2C), very low power, low profile capacitive micro machined accelerometer featuring a low pass filter, compensation for 0g offset and gain errors, and conversion to 6-bit digital values at a user configurable output data rate. The device

can be used for sensor data changes, product orientation, and gesture detection through an interrupt pin (INT). The device is housed in an extremely small 3mm x 3mm x 0.9mm DFN package. The MMA7660FC is accessible to the TWR-SENSOR MC9S08QE and the Tower Elevator (SDA1/SCL1) via I2C at address '1001'100'. The MMA7660FC also utilizes an interrupt pin (GPIO0/IRQ on Socket "A" or "B"), but is only accessible by the TWR-SENSOR MC9S08QE. Refer to the MMA7660FC data sheet for additional information.

3.3 TWRPI-MPL115A

The TWR-SENSOR-PAK includes the TWRPI-MPL115A. The TWRPI-MPL11A is a Tower Plug-in that features the Freescale MPL115A2 digital miniature barometer. The MPL115A2 is the I2C version of the Freescale barometer pressure sensor. The TWRPI-MPL115A can be inserted into either Socket "A" or Socket "B" on the TWR-SENSOR module.



Figure 8 - TWRPI-MPL115A

The MPL115A2 is an absolute pressure sensor with digital output for low cost applications. A miniature 5 x 3 x 1.2 mm LGA package ideally suits it for portable electronics and space constrained applications. Low current consumptions of 5 μ A during Active mode and 1 μ A during Shutdown (Sleep) mode target battery and other low-power applications. A wide operating temperature range from -40°C to +105°C fits demanding environmental requirements. MPL115A2 employs a MEMS pressure sensor with a conditioning IC to provide accurate pressure measurement from 50 to 115 kPa. An integrated ADC provides digitized temperature and pressure sensor outputs via an I2C port. Calibration Data is stored in internal ROM. Utilizing raw sensor output the host microcontroller executes a compensation algorithm to render Compensated Absolute Pressure with 1 kPa accuracy.

The MPL115A2 is accessible to the TWR-SENSOR MC9S08QE and the Tower Elevator (SDA1/SCL1) via I2C at address '1100'000'. The MPL115A2 also utilizes two GPIO signals for low power operation. These GPIOs are only accessible by the TWR-SENSOR MC9S08QE from either Socket "A" or Socket "B". GPIO0/IRQ controls the sleep state of the MPL115A2. GPIO1 enables/disables the I2C interface. Refer to the MPL115A2 data sheet for additional information.

3.4 TWRPI-MPR121

The TWR-SENSOR-PAK includes the TWRPI-MPR121. The TWRPI-MPR121 is a Tower Plug-in that features the Freescale MPR121 proximity capacitive touch sensor controller. The TWRPI-MPR121 can be inserted into Socket “C” on the TWR-SENSOR module.

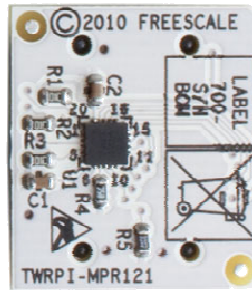

Figure 9 - TWRPI-MPR121

The MPR121 utilizes Freescale’s second generation capacitance detection engine and enhanced internal intelligence. The MPR121 features 12 fully independent electrodes with built-in auto-configuration, a hardware configurable I2C address, and an expanded filtering system with debounce. The device also features a 13th simulated electrode that represents the simultaneous charging of all the electrodes connected together to allow for increased proximity detection in a touch panel or touch screen array.

The MPR121 is accessible to the TWR-SENSOR MC9S08QE and the Tower Elevator (SDA1/SCL1) via I2C. The hardware configuration of the TWRPI-MPR121 connects the SCL pin to the ADDR pin, setting the configurable I2C address to ‘1001’111’. The MPR121 also utilizes an interrupt pin (GPIO0/IRQ on Socket “C”) but is only accessible by the TWR-SENSOR MC9S08QE. Refer to the MPR121 data sheet for additional information.

3.5 TWRPI-TSS

The TWR-SENSOR-PAK includes the TWRPI-TSS. The TWRPI-TSS is a Tower Plug-in that enables the use of the Freescale Touch Sensing Software Suite on the TWR-SENSOR MC9S08QE. The TWRPI-TSS can be inserted into Socket “C” on the TWR-SENSOR module.

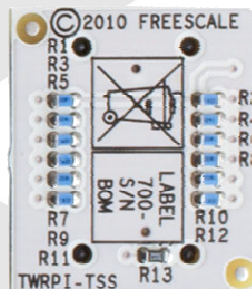

Figure 10 - TWRPI-TSS

The Touch Sensing Software (TSS) solution transforms a standard MCU into a proximity capacitive touch sensor controller. The touch sensor controller has an ability to manage multiple touch pad configurations and mechanical keys while maintaining its standard MCU control functionality. The library provides commonly used touch sense decoding structures as keypad, rotary, and slider. It is implemented in a layered architecture to enable easy integration into the application code, easy migration to other Freescale MCUs, and for customization by customers.

The purpose of the TWRPI-TSS is to identify to the TWR-SENSOR MC9S08QE that the Touch Sensing Software is to be used, relay the electrode signals from Socket “D” to the TWR-SENSOR MC9S08QE, and to provide resistive pull-ups on the electrode signals as required by the TSS implementation.

3.6 TWRPI-KEYPAD

The TWR-SENSOR-PAK includes the TWRPI-KEYPAD. The TWRPI-KEYPAD is a Tower Plug-in that implements a basic 12-key touchpad. The TWRPI-KEYPAD can be inserted into Socket “D” on the TWR-SENSOR module.

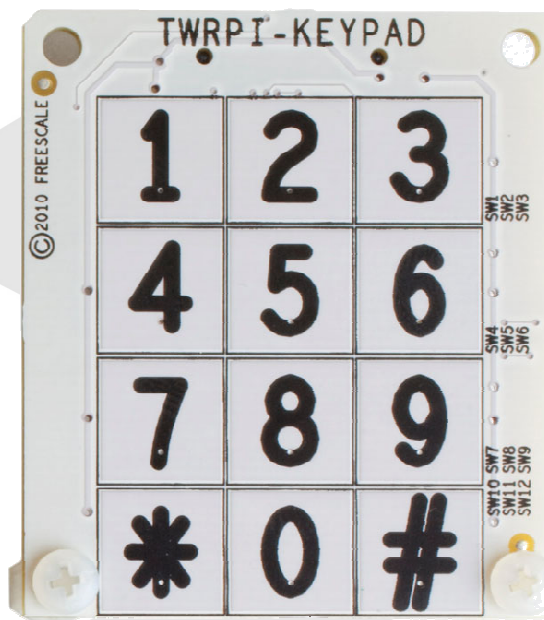

Figure 11 - TWRPI-KEYPAD

3.7 Elevator Connections

The TWR-SENSOR-PAK is designed for the Freescale Tower System and complies with the electrical and mechanical specification as describes in the Freescale Tower Electromechanical Specification. The TWR-SENSOR module features two expansion card-edge connectors that interface to the Elevator boards in a Tower System. The Primary Elevator connector, comprised of sides A and B, is utilized by the TWR-SENSOR module, while the Secondary Elevator connector only makes connections to ground (GND).

Table 7 - TWR-SENSOR-PAK Primary Elevator Connector Pinout

TWR-SENSOR Primary Connector									
Pin	Name	Usage	Used	Jmp	Pin	Name	Usage	Used	Jmp
B1	5V	5V Power	X		A1	5V	5V Power	X	
B2	GND	Ground	X		A2	GND	Ground	X	
B3	3.3V	3.3V Power	X		A3	3.3V	3.3V Power	X	
B4	ELE_PS_SENSE	ELE_PS_SENSE	X		A4	3.3V	3.3V Power	X	
B5	GND	Ground	X		A5	GND	Ground	X	
B6	GND	Ground	X		A6	GND	Ground	X	
B7	SDHC_CLK / SPI1_CLK				A7	SCL0	MCU/SENSOR: SCL	X	X
B8	SDHC_D3 / SPI1_CS1_b				A8	SDA0	MCU/SENSOR: SDA	X	X
B9	SDHC_D3 / SPI1_CS0_b				A9	GPIO9 / CTS1			
B10	SDHC_CMD / SPI1_MOSI				A10	GPIO8 / SDHC_D2			
B11	SDHC_D0 / SPI1_MISO				A11	GPIO7 / SD_WP_DET			
Separator									
B12	ETH_COL				A12	ETH_CRS			
B13	ETH_RXER				A13	ETH_MDC			
B14	ETH_TXCLK				A14	ETH_MDIO			
B15	ETH_TXEN				A15	ETH_RXCLK			
B16	ETH_TXER				A16	ETH_RXDV			
B17	ETH_TXD3				A17	ETH_RXD3			
B18	ETH_TXD2				A18	ETH_RXD2			
B19	ETH_TXD1				A19	ETH_RXD1			
B20	ETH_TXD0				A20	ETH_RXD0			
B21	GPIO1 / RTS1				A21	SSI_MCLK			
B22	GPIO2 / SDHC_D1				A22	SSI_BCLK			
B23	GPIO3				A23	SSI_FS			
B24	CLKIN0				A24	SSI_RXD			
B25	CLKOUT1				A25	SSI_TXD			
B26	GND	Ground	X		A26	GND		X	
B27	AN7				A27	AN3			
B28	AN6	Socket "B": Analog 2	X	X	A28	AN2	Socket "A": Analog 2	X	X
B29	AN5	Socket "B": Analog 1	X	X	A29	AN1	Socket "A": Analog 1	X	X
B30	AN4	Socket "B": Analog 0	X	X	A30	AN0	Socket "A": Analog 0	X	X
B31	GND	Ground	X		A31	GND	Ground	X	
B32	DAC1				A32	DAC0			
B33	TMR3				A33	TMR1			
B34	TMR2				A34	TMR0			
B35	GPIO4				A35	GPIO6			
B36	3.3V	3.3V Power	X		A36	3.3V	3.3V Power	X	
B37	PWM7				A37	PWM3			
B38	PWM6				A38	PWM2			
B39	PWM5				A39	PWM1			
B40	PWM4				A40	PWM0			
B41	CANRX0				A41	RXD0	MCU: UART RXD0	X	X
B42	CANTX0				A42	TXD0	MCU: UART TXD0	X	X

TWR-SENSOR Primary Connector									
Pin	Name	Usage	Used	Jmp	Pin	Name	Usage	Used	Jmp
B43	1WIRE				A43	RXD1	MCU: UART RXD1	X	X
B44	SPI0_MISO				A44	TXD1	MCU: UART TXD1	X	X
B45	SPI0_MOSI				A45	Analog VDD			
B46	SPI0_CS0_b				A46	Analog VSS			
B47	SPI0_CS1_b				A47	Analog Vref			
B48	SPI0_CLK				A48	Analog Vref			
B49	GND	Ground	X		A49	GND			
B50	SCL1	Sensor/MCU: ELE_SCL1	X	X	A50	GPIO14			
B51	SDA1	Sensor/MCU: ELE_SDA1	X	X	A51	GPIO15			
B52	GPIO5 / SD_CARD_DET				A52	GPIO16			
B53	USB0_DP_PDOWN				A53	GPIO17			
B54	USB0_DM_PDOWN				A54	USB0_DM			
B55	IRQ_H				A55	USB0_DP			
B56	IRQ_G				A56	USB0_ID			
B57	IRQ_F				A57	USB0_VBUS			
B58	IRQ_E				A58	TMR7			
B59	IRQ_D				A59	TMR6			
B60	IRQ_C				A60	TMR5			
B61	IRQ_B				A61	TMR4			
B62	IRQ_A				A62	RSTIN_b			
B63	EBI_ALE / EBI_CS1_b				A63	RSTOUT_b	MCU: Reset	X	
B64	EBI_CS0_b				A64	CLKOUT0			
B65	GND	Ground	X		A65	GND	Ground	X	
B66	EBI_AD15				A66	EBI_AD14			
B67	EBI_AD16				A67	EBI_AD13			
B68	EBI_AD17				A68	EBI_AD12			
B69	EBI_AD18				A69	EBI_AD11			
B70	EBI_AD19				A70	EBI_AD10			
B71	EBI_R/W_b				A71	EBI_AD9			
B72	EBI_OE_b				A72	EBI_AD8			
B73	EBI_D7				A73	EBI_AD7			
B74	EBI_D6				A74	EBI_AD6			
B75	EBI_D5				A75	EBI_AD5			
B76	EBI_D4				A76	EBI_AD4			
B77	EBI_D3				A77	EBI_AD3			
B78	EBI_D2				A78	EBI_AD2			
B79	EBI_D1				A79	EBI_AD1			
B80	EBI_D0				A80	EBI_AD0			
B81	GND	Ground	X		A81	GND	Ground	X	
B82	3.3V	3.3V Power	X		A82	3.3V	3.3V Power	X	

4 Jumper Table

There are several configuration switches provided for isolation, configuration, and feature selection. Refer to the following table for details. The default installed dip switch settings are shown in ***1-2***.

Table 8 - TWR-SENSOR Jumper Table

Jumper	Name	Setting	Description
J2	BTLD	1-2	Shunt to enable Boot Loader Mode
J3	MCU 3V3	*1-2*	Connects 3V3 to MCU. Use to measure MCU current consumption.
J4	ANA EN	1-2	Connects Analog Signal (MA_AN0) from Socket A to the Primary Tower Elevator signal ELEN_MA_AN0
		3-4	Connects Analog Signal (MA_AN1) from Socket A to the Primary Tower Elevator signal ELEN_MA_AN1
		5-6	Connects Analog Signal (MA_AN2) from Socket A to the Primary Tower Elevator signal ELEN_MA_AN2
		7-8	Connects Analog Signal (MB_AN0) from Socket B to the Primary Tower Elevator signal ELEN_MB_AN4
		9-10	Connects Analog Signal (MB_AN1) from Socket B to the Primary Tower Elevator signal ELEN_MB_AN5
		11-12	Connects Analog Signal (MB_AN2) from Socket B to the Primary Tower Elevator signal ELEN_MB_AN6
J5	SERIAL CFG	1-2	Shunt to enable Slave Mode Serial Connection to Tower Elevator UART 0 Connects MCU_RXD2 to ELE_TXD0
		3-4	Shunt to enable Slave Mode Serial Connection to Tower Elevator UART 0 Connects MCU_TXD2 to ELE_RXD0
		5-6	Shunt to enable Slave Mode Serial Connection to Tower Elevator UART 1 Connects MCU_RXD2 to ELE_TXD1
		7-8	Shunt to enable Slave Mode Serial Connection to Tower Elevator UART 1 Connects MCU_TXD2 to ELE_RXD1
		1-3	Shunt to enable Master Mode Serial Connection to Tower Elevator UART 0 Connects MCU_RXD2 to ELE_RXD0
		2-4	Shunt to enable Master Mode Serial Connection to Tower Elevator UART 0 Connects MCU_TXD2 to ELE_TXD0
		5-7	Shunt to enable Master Mode Serial Connection to Tower Elevator UART 1 Connects MCU_RXD2 to ELE_RXD1
		6-8	Shunt to enable Master Mode Serial Connection to Tower Elevator UART 1 Connects MCU_TXD2 to ELE_TXD1

Jumper	Name	Setting	Description
J6	I2C EN	1-2	Shunt to enable Sensor I2C Connection to Tower Elevator I2C 1 Connects SENS_SDA to ELE_SDA1
		3-4	Shunt to enable MCU I2C Connection to Tower Elevator I2C 0 Connects MCU_SDA to ELE_SDA0
		5-6	Shunt to enable Sensor I2C Connection to Tower Elevator I2C 1 Connects SENS_SCL to ELE_SCL1
		7-8	Shunt to enable MCU I2C Connection to Tower Elevator I2C 0 Connects MCU_SCL to ELE_SCL0
		1-3	Shunt to enable Sensor I2C Connection to Tower Elevator I2C 0 Connects SENS_SDA to ELE_SDA0
		2-4	Shunt to enable MCU I2C Connection to Tower Elevator I2C 1 Connects MCU_SDA to ELE_SDA1
		5-7	Shunt to enable Sensor I2C Connection to Tower Elevator I2C 0 Connects SENS_SCL to ELE_SCL0
		6-8	Shunt to enable MCU I2C Connection to Tower Elevator I2C 1 Connects MCU_SCL to ELE_SCL1
J9	OSBDM / SER	*1-2*	Shunt to enable Serial-to-USB Application Unshunt to enable OSBDM

5 Mechanical Form Factor

The TWR-SENSOR-PAK is designed for the Freescale Tower System as a side mounting peripheral and complies with the electrical and mechanical specification as described in *Freescale Tower Electromechanical Specification*.



Freescale™ and the Freescale logo are trademarks of Freescale Semiconductor, Inc. All other product or service names are the property of their respective owners.

© Freescale Semiconductor, Inc. 2009. All rights reserved.