

MPC8349E MDS Processor Board

User Manual

Rev. 1.6
12/2005



Section 1 General Information

1.1	Introduction	7
1.1.1	MPC8349E MDS Processor Board	7
1.1.2	Working Configurations	8
1.1.2.1	Stand-Alone:	8
1.1.2.2	With PIB board (PIB Combined Mode):	8
1.1.2.3	PCI Add-On (Agent Mode):	8
1.2	Definitions, Acronyms, and Abbreviations	9
1.3	Related Documentation	10
1.4	Specifications	10
1.5	MPC8349E MDS Processor Board Features	11
1.6	External Connections	12
1.7	Block Diagram	14

Section 2 Hardware Preparation and Installation

2.1	Unpacking Instructions	15
2.2	Installation Instructions	15
2.2.1	Stand-Alone Mode	16
2.2.3	For Agent Mode only :	25

Section 3 Memory Map

3.1	MPC8349E MDS Processor Board Mapping	27
-----	--	----

Section 4 Controls and Indicators

4.1	Switches and Jumpers Locations	29
4.1.1	Switches	30
4.1.2	Jumpers	30
4.2	LEDs	30
4.2.1	LD1, LD2 - Signaling LEDs	30
4.2.2	LD3 - USB Power	30
4.2.3	LD4, LD5 - GETH Enable	30
4.2.4	LD6 - DUART Enable	30
4.2.5	LD7 - FUNC Indication	30
4.2.6	LD8 - Power GOOD	30
4.2.7	LD9 - GPIO1-1 Indication	30

4.2.8	LD10, LD11 - PCTL0,1 USB	30
4.2.9	LD12 - BOOT Indicator	30
4.2.10	LD13 - 5V Power Indicator	31
4.3	Other Controls and Indicators	31

Section 5

Functional Description

5.1	Reset & Reset - Configuration	33
5.1.1	Power - On Reset	33
5.1.2	Hard Reset	33
5.1.2.1	COP/JTAG Port Hard - Reset (stand-alone only)	34
5.1.2.2	Manual Hard Reset	34
5.1.2.3	Manual Soft Reset	34
5.2	Board Control & Status Registers – BCSR	34
5.2.1	BCSR0 - Board Control / Status Register 0	35
5.2.2	BCSR1 - Board Control / Status Register 1	36
5.2.3	BCSR2 - Board Control / Status Register 2	37
5.2.4	BCSR3 - Board Control / Status Register 3	37
5.2.5	BCSR4 - Board Control / Status Register 4	38
5.2.6	BCSR5 - Board Control / Status Register 5	40
5.2.7	BCSR6 - Board Misc. Register 1	41
5.2.8	BCSR7 - Board Misc. Register 2	41
5.2.9	BCSR8 - Board Misc. Register 3	42
5.2.10	BCSR10 - Board Status Register 1	43
5.2.11	BCSR11 - Board Status Register 2	43
5.2.12	CCR - COP Control Register	44
5.3	External Connections	45
5.3.1	P1 - MiniAB USB Connector	45
5.3.2	P2 - DUART Port	45
5.3.3	Logic Analyzer Connectors	46
5.3.4	P5 - SMB Connector	46
5.3.5	P9 - Debug COP Connector	46
5.3.6	P10 - FPGA's In-System-Programming (ISP)	48
5.3.7	P11 - Power Connector	48
5.3.8	J1,J2 - Ethernet Port Connector	49

Section 6

Clocking for the MPC8349E MDS Processor Board

6.1	MPC8349 as Host Device	51
6.2	MPC8349 as Agent	52

Section 7

Replacing Devices

7.1	Replacing Flash Memory	53
	7.1.1 Cleaning Flash Memory	55
7.2	Replacing SODIMM units	56
7.3	Replacing MSC8349E Processor	58

General Information

1.1 Introduction

This document describes the MPC8349E MDS Processor Board, in its stand-alone operating mode, in addition to its operating mode via a PCI slot in a PC, or its operating mode on the “PowerQUICC MDS Platform I/O Board (PIB)”.

1.1.1 MPC8349E MDS Processor Board

The MPC8349E MDS Processor Board is an ADS that provides a complete debugging environment for engineers developing applications for the MPC8349 series of Freescale processors.

The MPC8349E is a cost-effective, general purpose integrated host processor that implements the PowerPC™ architecture required for networking infrastructure, telecommunications, Wireless LANs, and other embedded applications. The MPC8349E can also be used for control processing in applications such as network routers and switches, mass storage subsystems, network appliances, and print and imaging systems.

The MPC8349E MDS Processor Board includes various peripherals, such as data input/output devices (GETH, USB, DUART), memories (DDR, SDRAM (optional), Serial EEPROM, PSRAM (optional) & FLASH and BCSR’s registers), and control switches and LED indicators.

Using its on-board resources and debugging devices, a developer is able to upload code, run the code, set breakpoints, display memory & registers and connect his own proprietary hardware to be incorporated into a target system that uses the MPC8349E as a processor.

The software application developed for the MPC8349 can be run in a "bare bones" operation (with only the MPC8349 processor), or with various input or output data streams, such as from the GETH connection, PCI or the USB connections. Results can be analyzed using the *Code Warrior*® debugger in addition to using other methods for directly analyzing the input or output data stream. The BSP is built using the Linux OS.

This board can also be used as a demonstration tool for the developer. For instance, the developer's application software may be programmed into its Flash memory and run in exhibitions.

1.1.2 Working Configurations

1.1.2.1 Stand-Alone:

The MPC8349E MDS Processor Board can be run in a stand-alone mode, like other ADS's, with direct connections to debuggers (via a JTAG/COP connector and JTAG/Parallel Port command converter), power supply, and the GETH, MiniAB USB and Dual RS-232 (DUART) connections. In this mode, the MPC8349E MDS Processor Board acts as a Host.

1.1.2.2 With PIB board (PIB Combined Mode):

The MPC8349E MDS Processor Board can be connected to the PIB, which allows it to be used in a back plane, and provides room and connections for an additional USB board, and up to three additional PCI cards. Each of the PCI cards provides a connection interface for an optional additional processor board (from the MPC83xx family). This capability allows the MPC8349 processor on the MPC8349E MDS Processor Board to act as a master for up to three "slave" processors in the MPC83xx family. In this mode, the MPC8349E MDS Processor Board acts as a Host.

Voltage is provided by the PIB, which also provides additional signal connections via the back plane (if used), and optical GETH connectors on the front plane side of the PIB. The MPC8349E MDS Processor Board can be connected to a PC in this configuration (via a parallel port connector), without needing an external command converter.

1.1.2.3 PCI Add-On (Agent Mode):

Using its PCI edge connector, the MPC8349E MDS Processor Board can be inserted in a PC. Power and debugging are supplied from the PC (no command converter necessary). Other external connections are the same as in the Stand-Alone Mode. In this mode, the MPC8349E MDS Processor Board acts as an Agent.

1.2 Definitions, Acronyms, and Abbreviations

ADS	Application Development System
BCSR	Board Control and Status Register
BRD	Board Revision Detect (I2C EEPROM)
BSP	Board Support Package
CCR	COP Control Register (FPGA)
COP	Common On-chip Processor (JTAG Debug Port)
CS	Chip Select
CW	Metrowerks <i>Code Warrior</i> [®] IDE for PowerPC
DAC	Digital-to-Analog Converter
DDR	Double Data Rate
DIP	Dual-In-Line Package.
DMA	Direct Memory Access
DUART	Dual UART
EEPROM	Electrical Erasable Programmable Memory
FCFG	Flash Configuration Select
FCI	Type of Riser Connector
FLASH	Non volatile reprogrammable memory.
FPGA	Field-Programmable Gate Array
GbE	Gigabit Ethernet
GETH	Gigabit Ethernet
GPCM	General Purpose Chip-select Machine
GPL	General Purpose Line
I2C	Philips Semi Serial Bus
LED	Light Emitting Diode
lsb	least significant bit
MII	Media Independent Interface
GMII	General Media Independent Interface
JTAG	Joint Test Access Group
OTG	On-the-Go
PC	IBM-compatible Personal Computer

PCI	Peripheral Components Interconnect
Phy	Physical Layer
PIB	Platform I/O Board - expands the ADS functionality.
PSRAM	Pseudo-Static Random Access Memory
PSU	Power Supply Unit
RCWL, RCWH	Reset Configuration Word Low/High
RGMII	Reduced General Media Independent Interface
RTC	Real Time Clock
SDRAM	Synchronous Dynamic Random Access Memory
SMB	Type of Mini-RF connector
SODIMM	Mini DIMM Form Factor
SPD	Serial Present Detect
TBD	To Be Defined
TSEC	Triple Speed Ethernet Controller
ULPI	UTMI+ Low Pin Interface
UPM	User Programmable Machine
USB	Universal Serial Bus
ZD	Zero Delay clock buffer, with internal PLL for skew elimination

1.3 Related Documentation

- MPC8349 HW Specification
- MPC8349 User’s Manual
- PowerQUICC MDS Platform I/O Board User’s Manual
- MPC8349 *Getting Started*

1.4 Specifications

The MPC8349E MDS Processor Board specifications are given in Table 1-1.

Table 1-1. MPC8349E MDS Processor Board specifications

CHARACTERISTICS	SPECIFICATIONS
Power requirements	5V @ 3A external DC power supply (Stand-Alone Mode). No extra power supply for Agent Mode & PIB Combined Mode. In the case of the Agent Mode, power is supplied by the PC; In the PIB Combined Mode (a Host mode), either an external power supply provides power, OR power is supplied from the back plane connection.
MPC8349E processor	Internal clock runs up to 667MHz @ 1.2V
Memory: DDR:	256MB space 64bit wide in one SODIMM-200 . Data rate 333MHz.
Local Bus: SDRAM (Optional) Buffered Memory (Flash on socket): PSRAM (optional) BCSR on FPGA Expansion	64MB space 32bit wide + 4bit parity implemented in three SDRAM parts. 133MHz clock. 8MB space 16bits wide. 4MB space 16bits wide, use for Flash emulation. 16-registers, 8bits wide. Four banks with 16bit- Address bus, 16bit- Data bus
Operating temperature	0°C - 70°C
Storage temperature	-25°C to 85°C
Relative humidity	5% to 90% (non-condensing)
Dimensions (according to PCI 64-bit Add-in-card form factor): Length Width Height	285 mm 106 mm 16 mm

1.5 MPC8349E MDS Processor Board Features

- Supports MPC8349 running up to 667MHz at 1.2V Core voltage.
- DDR-1 333MHz on SODIMM. Second SODIMM is optional.
- PCI edge connector interfaces with 64-bit PCI bus (used when inserted in a PC).
- Two 10/100/1000Mb/sec Ethernet Phys on TSEC ports.
- USB 2.0 ULPI High Speed OTG Transceiver.
- Dual RS232 transceiver on one DUART port.

- Local Bus interface:
 - Three parts of 133MHz SDRAM memory (optional), 64Mbyte size with parity.
 - One 8Mbyte (expandable) Flash with 16bit port size in socket.
 - Address Latch and Buffers to support slow devices on the PIB Board.
 - Mictor Logic Analyzer Connector on mux bus for evaluation only.
- Two Hi-speed Riser Connectors to enable connection to the PIB Board.
- Debug port access via dedicated 16-pin connector (COP), via PCI port or from parallel port interface on the PIB.
- One I2C port for EEPROM 256Kbyte, Real Time Clock (RTC) and SODIMM SPD EEPROM parts - the second I2C port connects to the Board Revision Detect 1Kbyte EEPROM.
- Can function in one of three configurations:
 - Stand-alone.
 - As a PCI add-in card for a standard PC computer (Agent Mode).
 - PIB combined mode - development platform with Processor Board and PIB connected together.
- Board Control and Status Register (BCSR) implemented in Xilinx FPGA.
- Three power options:
 - Main 5V power is fed from external power supply for stand-alone mode.
 - Power from PC supply when acting as a PCI add-in card.
 - Power from the PIB when PIB and Processor Boards are combined.
- PCI add-in card form factor dimensions: 285mm x 106mm.

1.6 External Connections

The MPC8349E MDS Processor Board interconnects with external devices via the following set of connectors:

- P1 - MiniAB USB connector.
- P2 - RJ45-10 for DUART signals.
- P3, P6, P7, P8 - four Logic Analyzer MICTOR Connectors.
- P4 - 64-bit PCI Edge Connector.
- P5 - SMB RF Connector for external pulse generator - not assembled.
- P9 - 16-pin COP/JTAG Connector.
- P10 - 16-pin header for FPGA In-System Programming.
- P11 - Voltage Input
- P12,P13 - 300-pin FCI Expansion Connectors.
- J1,J2 - RJ45 8pin Gigabit Ethernet Connectors.

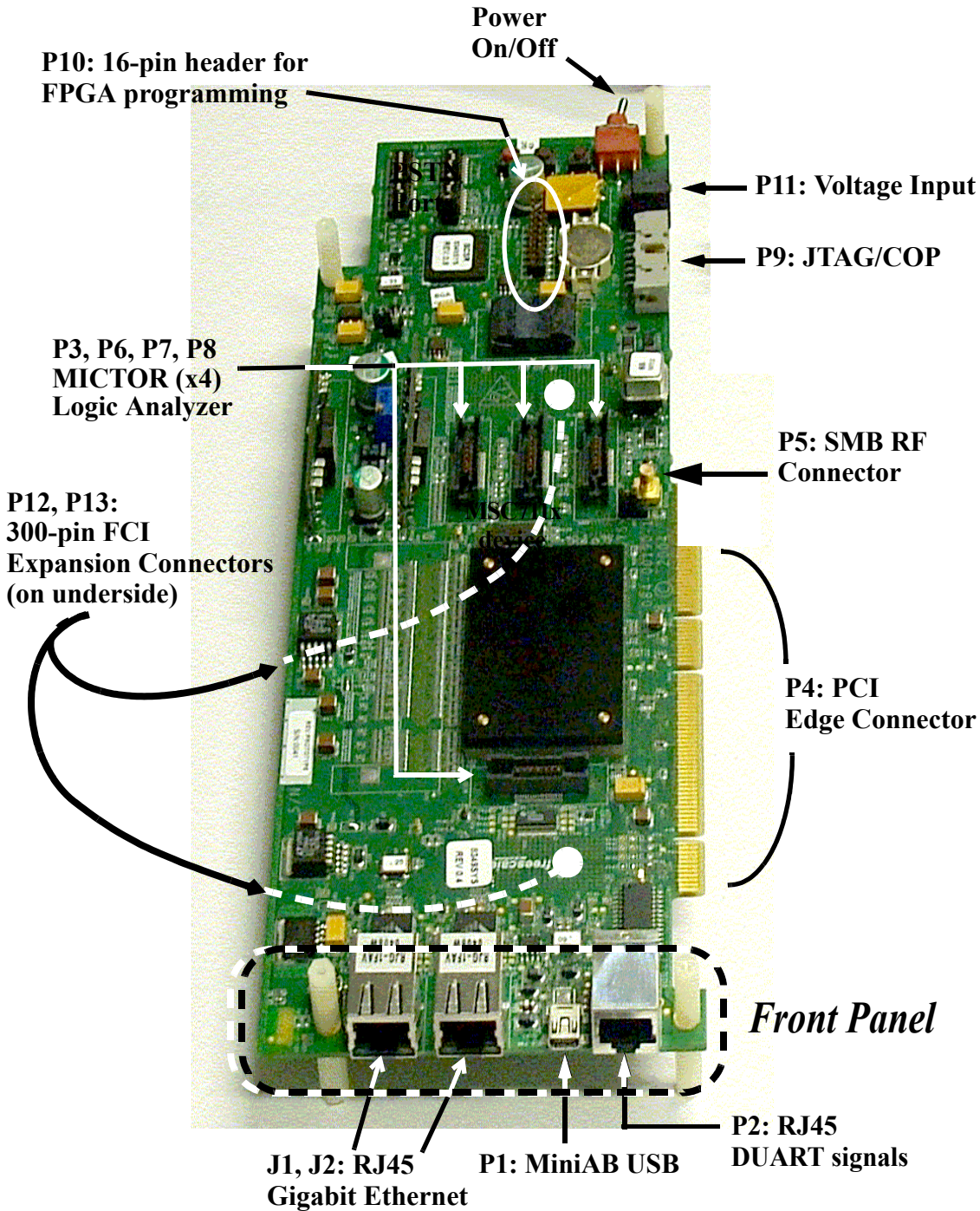

Figure 1-1 MPC8349E MDS Processor Board External Connections

1.7 Block Diagram

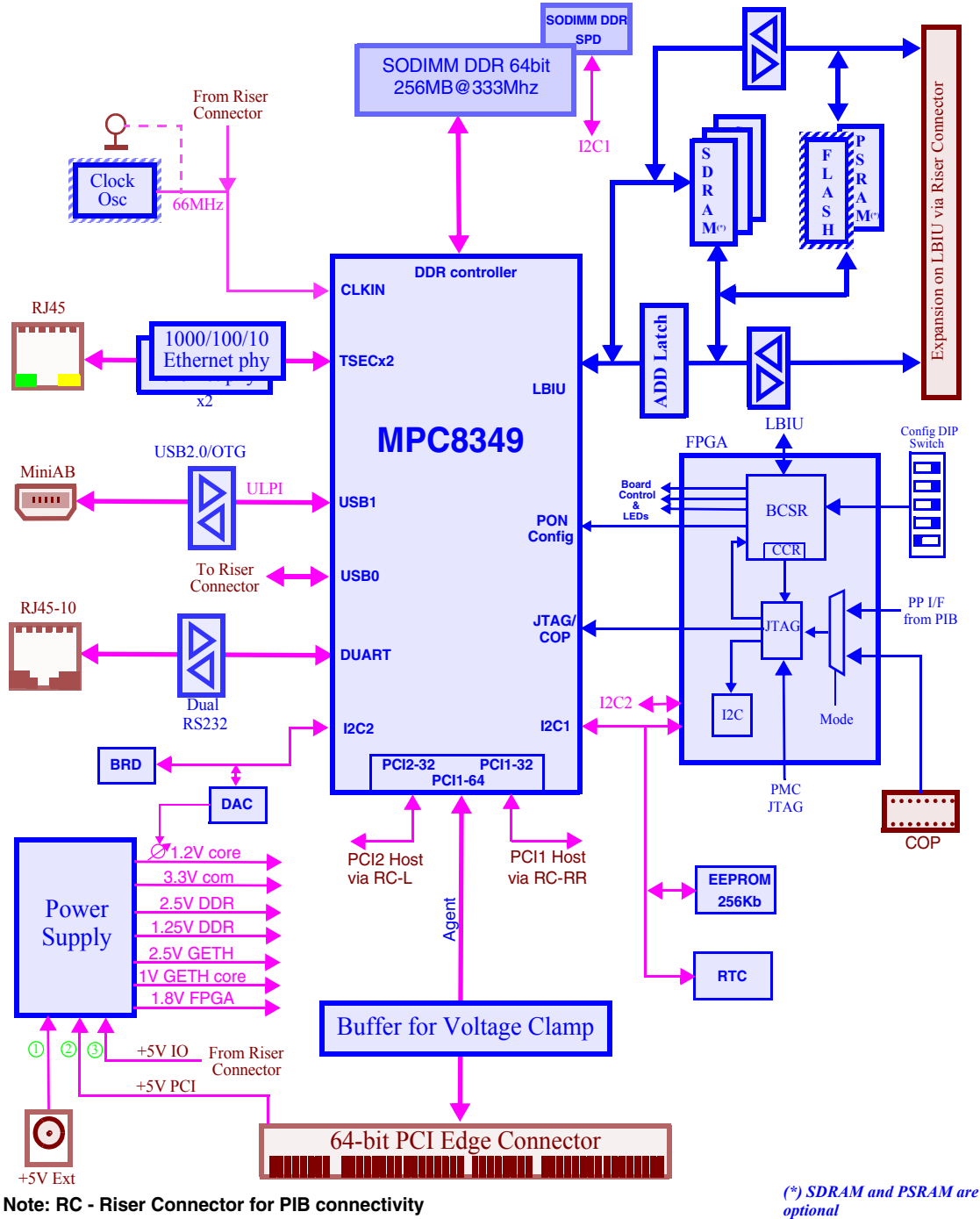

Figure 1-2 MPC8349E MDS Processor Board Block Diagram

Hardware Preparation and Installation

This chapter provides unpacking instructions, hardware preparation, and installation instructions for the MPC8349E MDS Processor Board, including all three configurations: Stand-Alone, PIB Combined Mode, and Agent Mode (inserted in a PC). For more details on hardware preparation, see the “Getting Started” document for the MPC8349E MDS Processor Board.

2.1 Unpacking Instructions

NOTE

If the shipping carton is damaged upon receipt, request carrier’s agent to be present during unpacking and inspection of equipment.

CAUTION

AVOID TOUCHING AREAS OF INTEGRATED CIRCUITRY; STATIC DISCHARGE CAN DAMAGE CIRCUITS.

1. Unpack equipment from shipping carton.
2. Refer to packing list and verify that all items are present.
3. Save packing material for storing and reshipping of equipment.

2.2 Installation Instructions

Do the following *in order* to install the MPC8349E MDS Processor Board properly:

1. Verify that Jumpers and Switches are in default positions. For default positions, see the “Getting Started” document for the MPC8349E MDS Processor Board.
2. Determine in which working configuration you will operate the MPC8349E MDS Processor Board:
 - Stand-Alone - continue from Section 2.2.1
 - PIB Combined Mode, with the PIB Board - continue from Section 2.2.2
 - Agent Mode (installed in a PC) - continue from Section 2.2.3

2.2.1 Stand-Alone Mode

1. *For Stand-Alone Mode only:* Connect the four plastic spacers. See Figure 2-1 and Figure 2-2 .
2. Connect external cables in accordance with your laboratory environment.
3. Connect PSU (to P11), and turn the power on-off switch to ON.
4. Verify that LD1 and LD2 turn on and turn off (see Figure 2-3 for location). They should be on for only a few moments. This indicates that the board has successfully completed the boot-up sequence. (

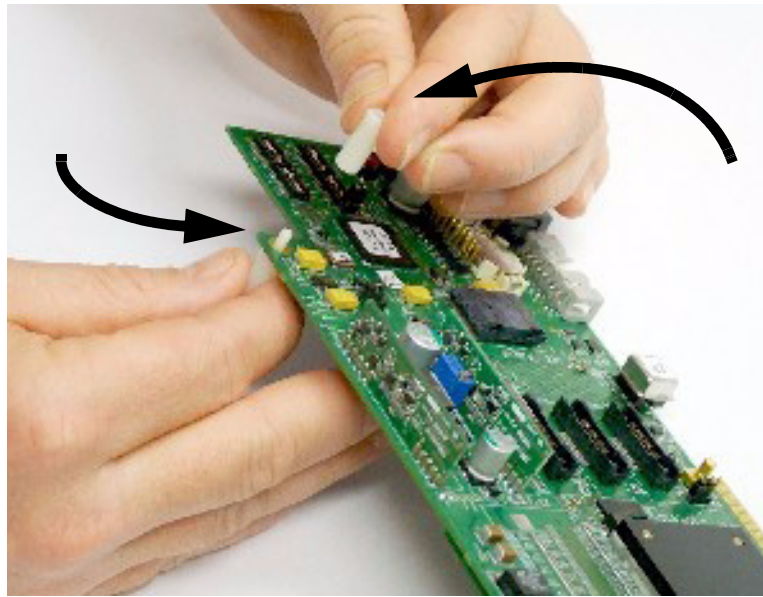

Figure 2-1 Connecting Plastic Spacers

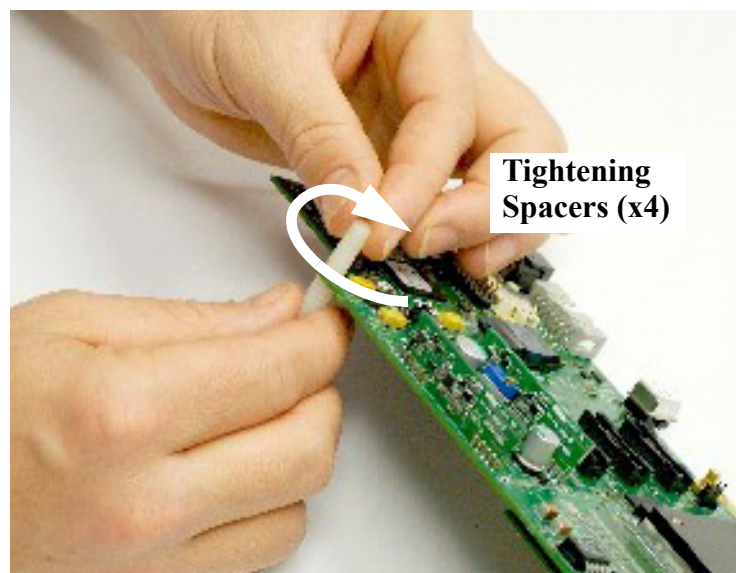

Figure 2-2 Tightening Plastic Spacers

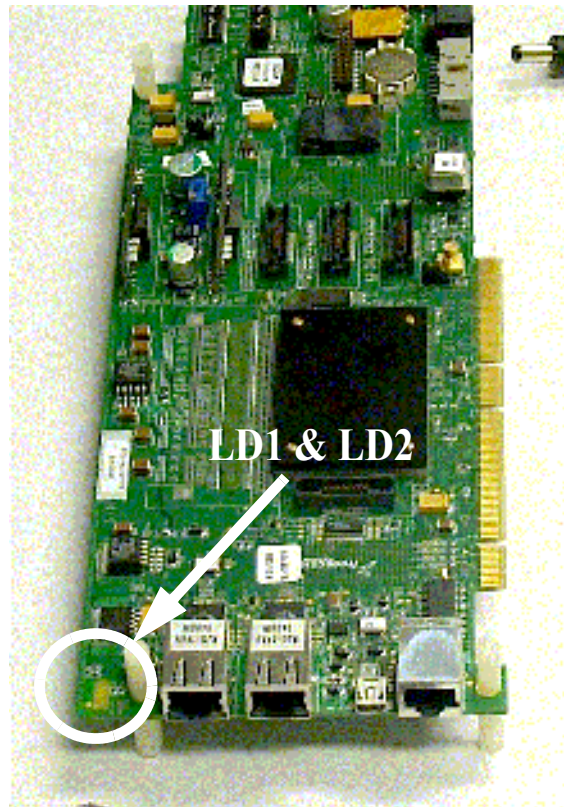

Figure 2-3 Boot-Up sequence: LD1 and LD2 (turn on, then off)

2.2.2 For PIB combined mode only:

1. Remove protective covers from the 300-pin connectors on the bottom side of the processor board (See Figure 2-4).
2. Remove protective covers from the 300-pin connectors on the PIB board (see Figure 2-5).

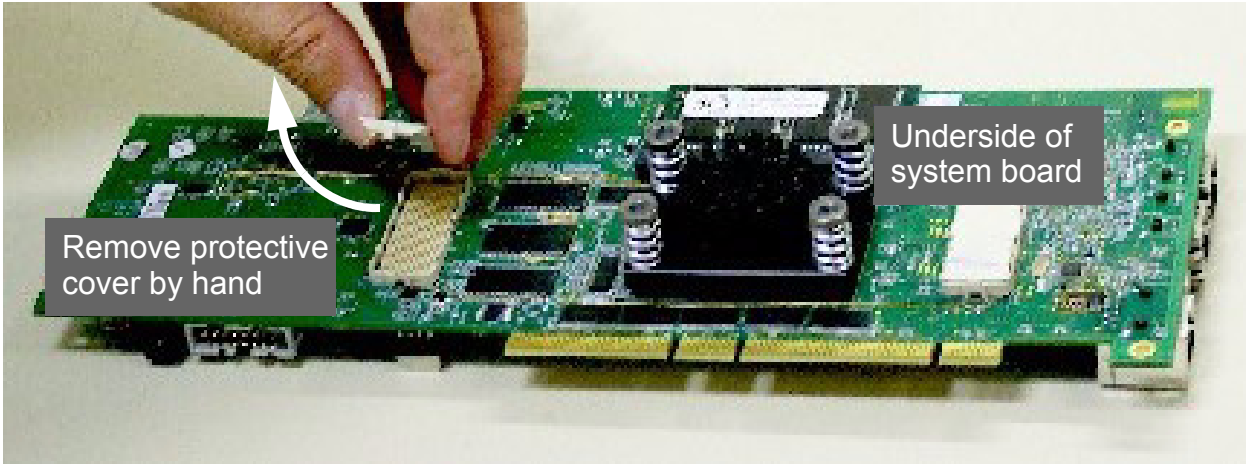

Figure 2-4 Remove Protective Covers from 300-pin connectors (underside of MPC8349E MDS Processor Board shown)

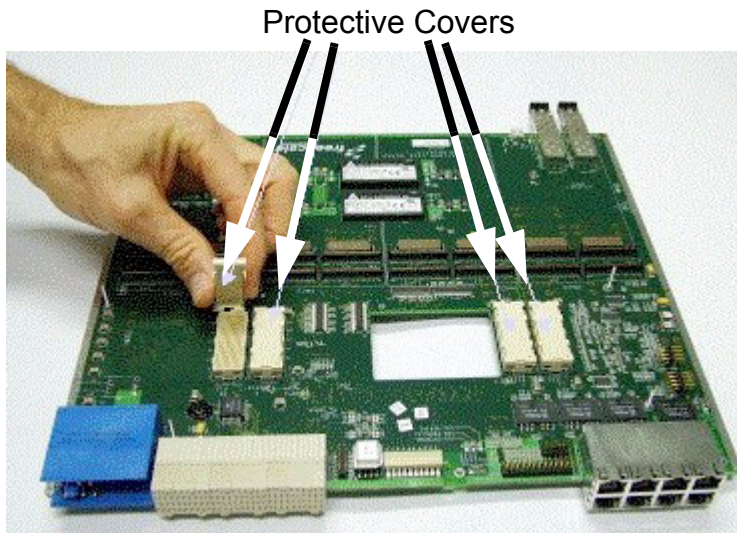

Figure 2-5 Remove Protective Covers from 300-pin connectors (underside of PIB shown)

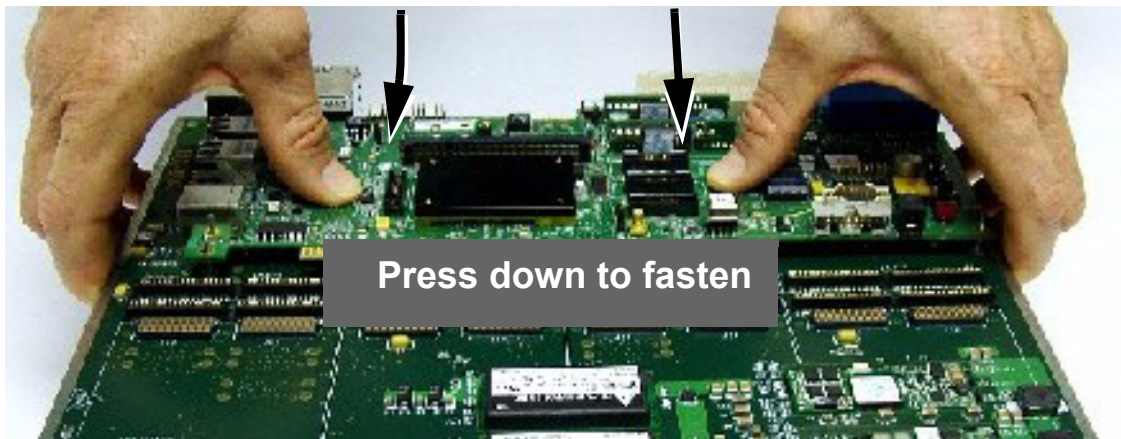

Figure 2-6 Connect Processor board to PIB and press down with fingers

3. Connect processor board to PIB board as shown in Figure 2-6.
4. Ensure a tight fit by pressing down on the processor board **by hand only** until the pins engage (see Figure 2-6)
5. Manually fasten the four screws as shown in Figure 2-7.

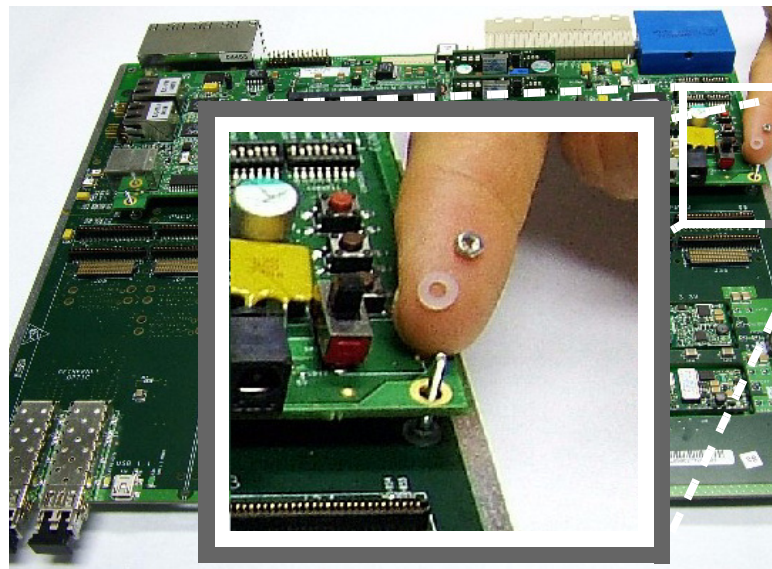

Figure 2-7 Fasten the four tightening screws

6. If you will be working with a back plane, and wish GETH signals to traverse either the back plane connection, or the front plane optical connection, connect the two GETH sockets on the MPC8349E MDS Processor Board with sockets on the PIB board as shown in Figure 2-8 and Figure 2-9.

Note that if you do not do this, you can still connect GETH cables directly to the Processor board's sockets, if they are accessible in your laboratory configuration.

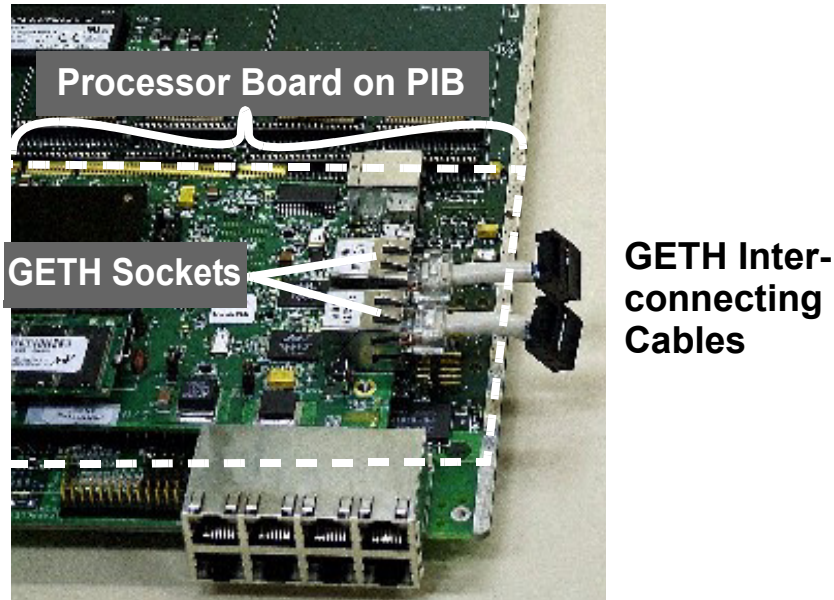

Figure 2-8 Insert GETH interconnecting cables to GETH sockets on Processor board

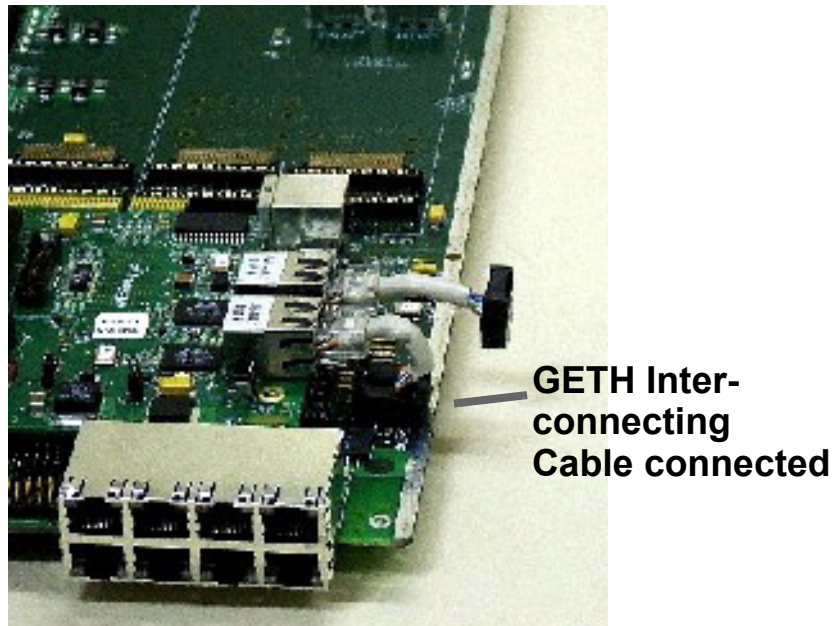

Figure 2-9 Connect GETH interconnecting cables to sockets on PIB

7. If you are not working with either the USB or the PCI cards, and you will be working with the PIB in a “table-top” configuration (as opposed to inserting it in a rack to use its back plane connections), you can at this point connect the power supply to the voltage input as shown in Figure 2-10.

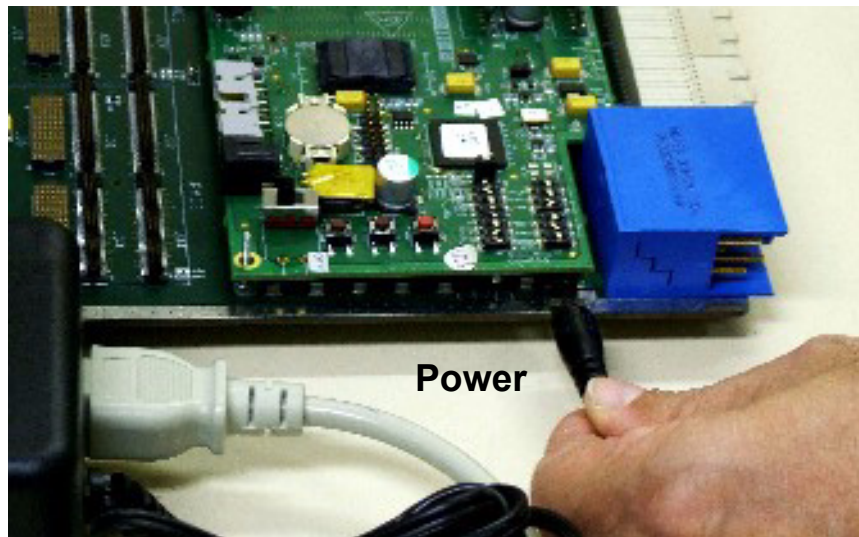

Figure 2-10 Connecting Power input to the PIB

8. If you wish to work with the USB card, or any of the PCI cards, follow the illustrations in Figure 2-11, Figure 2-12, and Figure 2-13 to connect these cards to the PIB.

Note that the USB card can only be inserted in the upper-most section, as shown. The PCI card can be inserted in any section, for up to 4 PCI cards (up to 3 if using also a USB card).

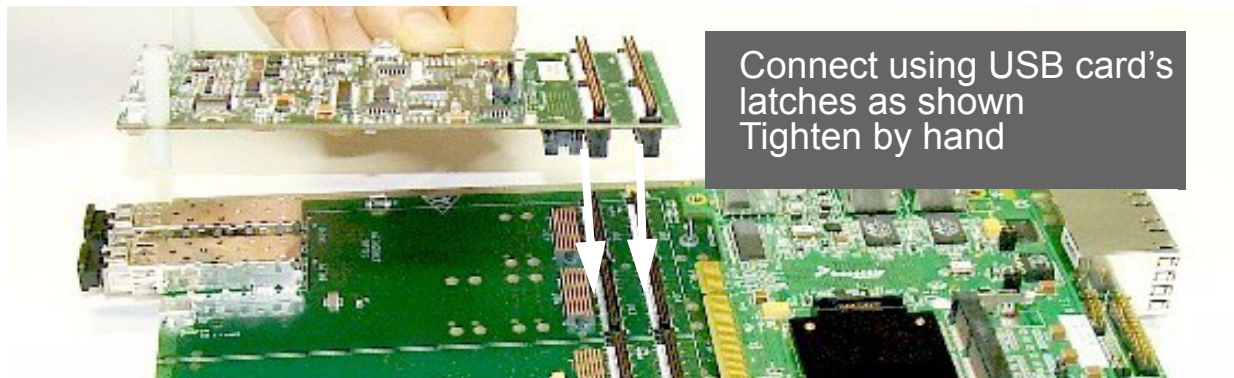

Figure 2-11 Connecting USB card to PIB

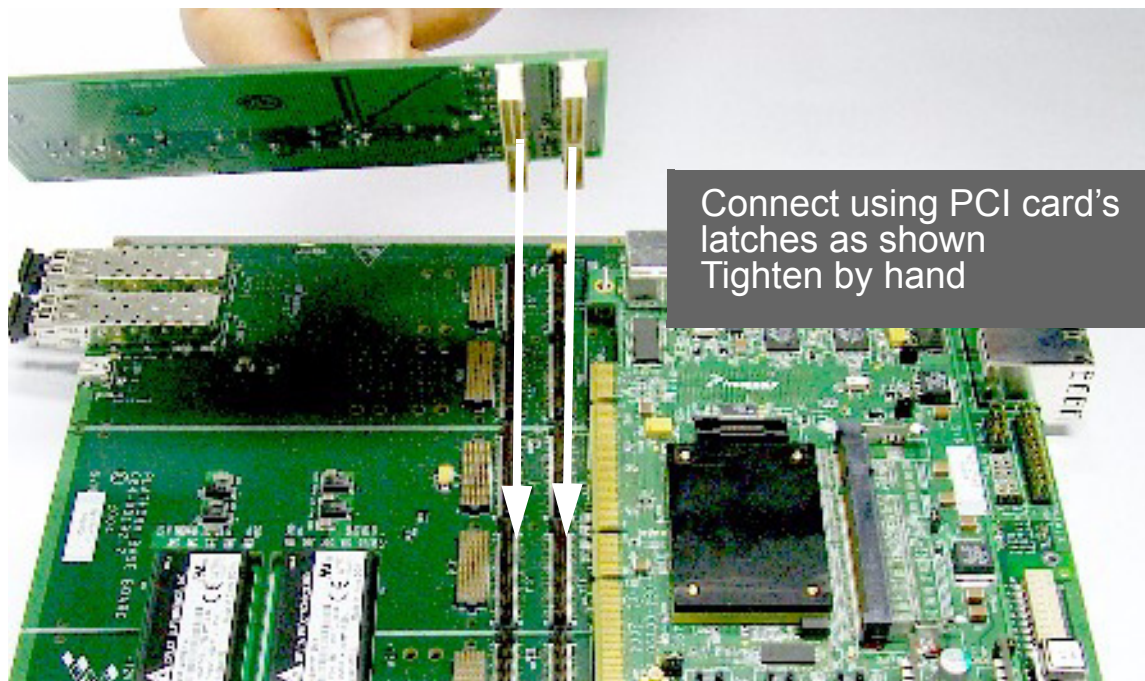

Figure 2-12 Connecting PCI card to PIB

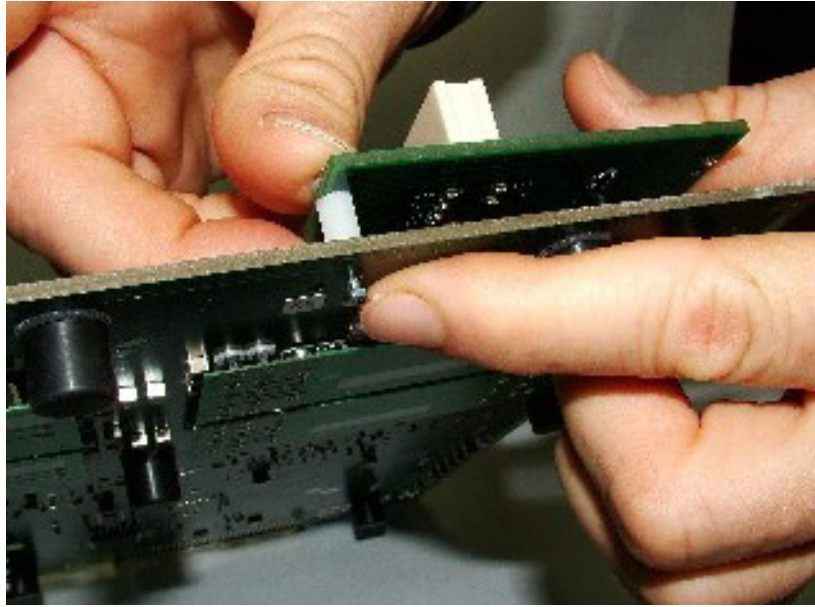

Figure 2-13 Inserting spacers between PCI card and PIB

- The fully assembled PIB-Processor board is shown in Figure 2-14, which also shows the PIB external connections relevant when the MPC8349 is used.

All external connections of the Processor board are active when the Processor board is installed on the PIB, except the voltage input (receives power from the PIB power input, or the back plane only), and the JTAG/COP connection (P9), which is replaced by the parallel port connection to a PC.

Three PCI cards and one USB card are shown installed on the PIB. The PCI cards are ready to receive any 83xx Processor board, installed in this case in the same manner as they are in a PC. Using this system, these processor boards (up to three) function as slaves, while the Processor board already installed functions as a master. This allows you to take advantage of the parallel processing capabilities of the 83xx line of products.

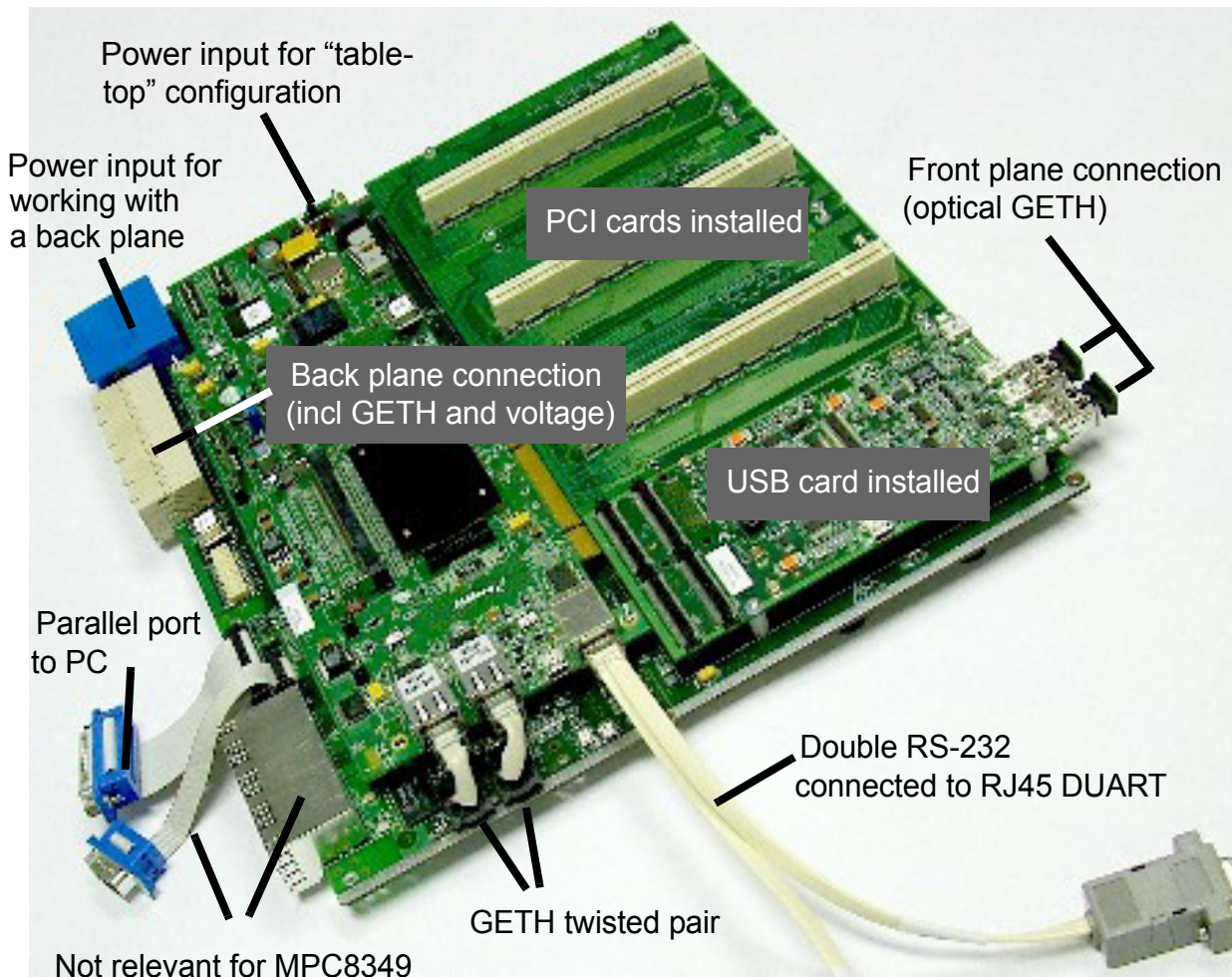

Figure 2-14 Fully Assembled Combined system:
PIB, Processor Board, USB, and PCI cards

2.2.3 For Agent Mode only :

1. Insert the MPC8349E MDS Processor Board into a PC, using its PCI edge connector.
2. Operate *Code Warrior*[®] to verify that the processor board has been installed properly.
3. Connect external cables in accordance with your laboratory environment.
4. Verify that LD1 and LD2 turn on and then turn off (see Figure 2-3 for location). They should be on for only a few moments. This indicates that the board has successfully undergone the boot-up sequence.



Memory Map

3.1 MPC8349E MDS Processor Board Mapping

The MPC8349 Memory Controller governs all accesses to the processor memory slaves. Consequently, the memory map may be reprogrammed according to user needs. After performing a Hard Reset, the debug host may initialize the memory controller via the JTAG/COP connector in order to allow additional access to bus addressable peripherals. The DDR,SDRAM and FLASH/PSRAM (optional) memories respond to all types of memory access - program/data and Direct Memory Access (DMA).

Table 3-1. MPC8349SYS Memory Map

Window Number	Address Range	Target	Device Name	Volume in Bytes	Port Size in Bits
7	00000000 - 0FFFFFFF (00000000 - 3FFFFFFF)	DDR SDRAM HYMD232M646D 6 w/o ECC MT9VDDT3272P HG with ECC	Main SODIMM CS2,CS3	256MB (1GB)	64+8 ECC
	Second SODIMM (optional) CS0,CS1		256MB (1GB)		
5	80000000 - 9FFFFFFF	PCI1	Inbound/Outbound window	512MB	32/64
6	A0000000 - BFFFFFFF	PCI2/Empty ^a	Inbound/Outbound window	512MB	32
-	C0000000 - DFFFFFFF	Empty Space	-	512MB	-
0	E0000000 - E0FFFFFF	8349	Internal Memory Register Space	1MB	32
-	E0100000 - EFFFFFFF	Empty Space	-	~256MB	-

Table 3-1. MPC8349SYS Memory Map

Window Number	Address Range	Target	Device Name	Volume in Bytes	Port Size in Bits
3	F0000000 - F2FFFFFF (F0000000 - F4FFFFFF)	Local Bus SDRAM(optional) on CS2	MT48LC16M16A2TG-6A x 2 MT48LC16M16A2TG-6A x 1 for parity (MT48LC32M16A2TG-7E)	64MB (128MB)	32+8 parity
-	F5000000 - F7FFFFFF	Empty Space	-	64MB	-
-	F8000000 - F8007FFF	BCSR on CS1	Xilinx FPGA	32KB	8
-	F8008000 - FFFFFFFF	Empty Space	-	~96MB	-
	FE000000 - FE7FFFFFF or FE000000 - FE3FFFFFF	FLASH on CS0 or PSRAM on CS0 (optional)	MT28F640 TC51WHM516AXBN70	8MB 4MB	16
-	FE800000 - FFFFFFFF	Empty Space	-	24MB	-

a.PCI2 Memory Space defined for PCI2 host mode

The memory map defined in Table 3-1. "MPC8349SYS Memory Map" is only a recommendation. The user can choose to work with alternative memory mapping. It should be noted that the described mode is supported by Metrowerks' *Code Warrior*[®] debug tool.

Controls and Indicators

This chapter describes controls and indicators of the MPC8349E MDS Processor Board. This includes switches, jumpers, LEDs, and other miscellaneous controls and indicators.

4.1 Switches and Jumpers Locations

Figure 4-1 below shows the locations of the Jumpers and DIP Switches. Note that when “ON”, the value of the switch is zero.

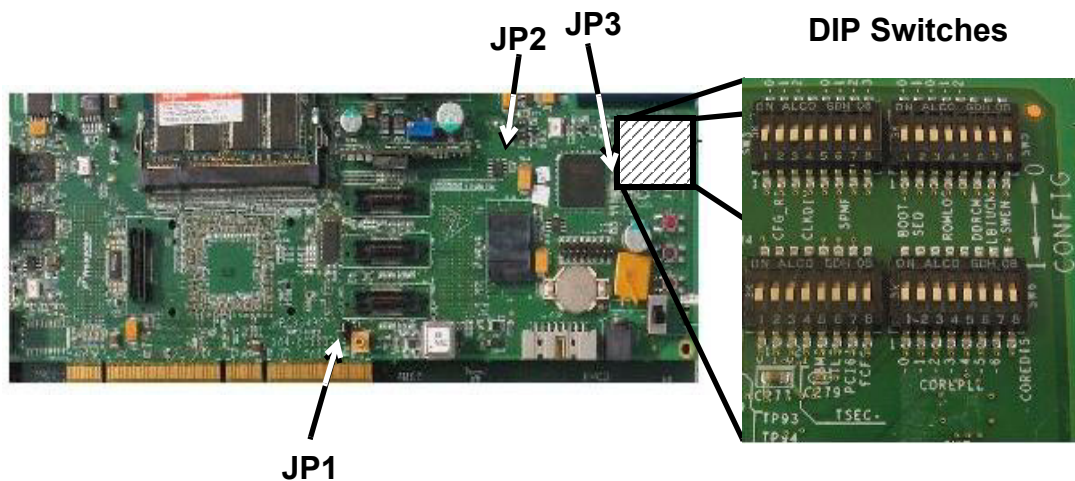

Figure 4-1 MPC8349E MDS Processor Board Switches and Jumpers Locations

4.1.1 Switches

The setting of DIP Switches are described in the publication *HW Getting Started Guide for the MPC8349E MDS Processor Board*.

4.1.2 Jumpers

MPC8349E MDS Processor Board jumpers are described in the publication *HW Getting Started Guide for the MPC8349E MDS Processor Board*.

4.2 LEDs

The MPC8349E MDS Processor Board has the following LEDs:

4.2.1 LD1, LD2 - Signaling LEDs

LED's, LD1 (**green**) and LD2 (**red**), are program controlled. They are used for extra visibility on the running utility. They are lit up by setting bits BCSR0.5-6 respectively.

4.2.2 LD3 - USB Power

When lit, the USB Vbus is powered.

4.2.3 LD4, LD5 - GETH Enable

The **green** LED, LD4,5, indicates enable for GETH Transceivers U5,U6.

4.2.4 LD6 - DUART Enable

A **green** LED, LD6, indicates enable for the RS232 Dual Transceiver.

4.2.5 LD7 - FUNC Indication

A **green** LED, LD7, indicates different board setting modes. LD7 blinks when the JTAG controller, implemented in Xilinx FPGA, is active.

4.2.6 LD8 - Power GOOD

A **green** LED, LD8, indicates that the MPC8349E MDS Processor Board power is operating normally.

4.2.7 LD9 - GPIO1-1 Indication

A **green** LED, LD9, indicates the state of the MPC8349 GPIO1-1 pin (U54/E24).

4.2.8 LD10, LD11 - PCTL0,1 USB

LED's LD10, LD11 (**green**) are used for extra visibility on the USB Port 1.

4.2.9 LD12 - BOOT Indicator

The LD12 indicates MPC8349 boot processing.

4.2.10 LD13 - 5V Power Indicator





The **green** LED, LD13, indicates a 5V power level on the MPC8349E MDS Processor Board.

A 5V power supply is plugged into the P11 Power Connector on the board's front side for the Stand-Alone Mode. The MPC8349E MDS Processor Board is powered by the 5V external power supply when the SW5 Power Switch is turned to the "ON" (up) position.

When the MPC8349E MDS Processor Board is plugged into an PC via the PCI edge connector it is powered from the edge connector's 5V power rail (Agent Mode). In the PIB Combined Mode, 5V power is supplied from the PIB's power supply via risers connectors. Note that if working in either of these two modes, the position of SW1 is ignored.

4.3 Other Controls and Indicators

Table 4-1. The MPC8349E MDS Processor Board Push Buttons

<p>SW1 Power-on-Reset</p>	 PRESET	<p>Pressing button SW1 results in Power-On-Reset for all components on the MPC8349E MDS Processor Board.</p> <p>Use this reset button when the MPC8349E MDS Processor Board is installed in a PC.</p>
<p>SW2 Software Option</p>	 SW OPT	<p>Rotary Switch SW2 allows the user to change the program flow according to eight available cases.</p> <p>Not available when installed in a PC.</p>
<p>SW8 Slave Hard Reset</p>	 HRESET	<p>Pressing button SW8 results in a Hard Reset for the MPC8349E.</p> <p>Not available when installed in a PC.</p>
<p>SW9 Soft Reset</p>	 SRESET	<p>Pressing button SW9 results in a Soft Reset for the MPC8349E. Despite the reset, clock and chip-select data as well as SDRAM (if installed) contents are retained.</p> <p>Not available when installed in a PC.</p>

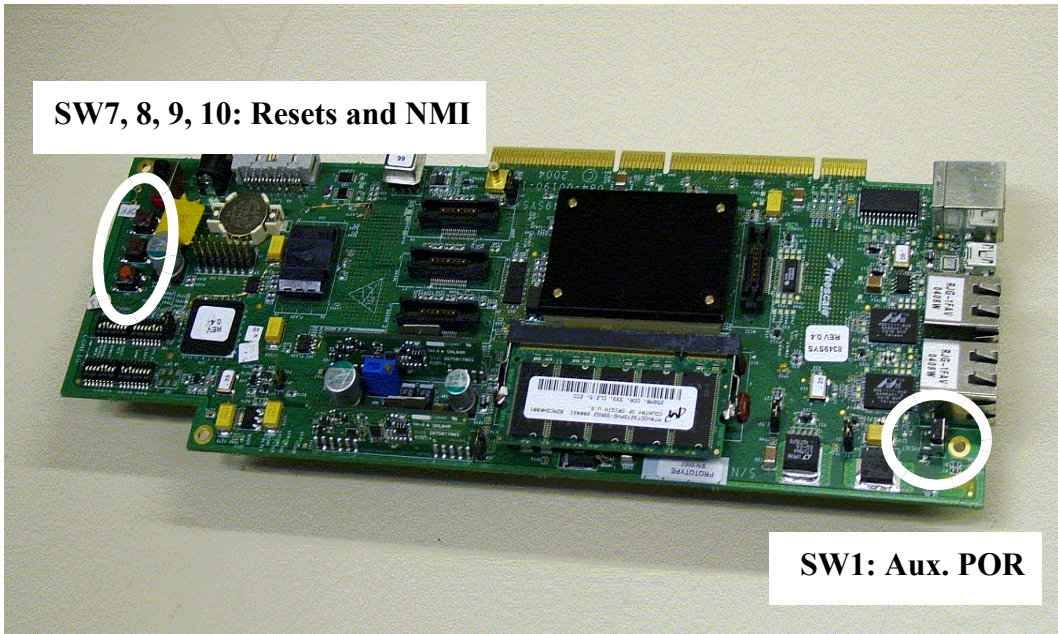

Figure 4-2 MPC8349E MDS Processor Board Push Buttons and Auxiliary POR

Functional Description

In this chapter the design details of various modules of the MPC8349E MDS Processor Board are described. This includes memory map details and software initialization of the board.

5.1 Reset & Reset - Configuration

There are several reset sources on the MPC8349E MDS Processor Board:

- Power On Reset
- Manual Hard-Reset
- Manual Soft-Reset
- MPC8349 (see also the MPC8349 U/M)

5.1.1 Power - On Reset

The power on reset to the MPC8349E MDS Processor Board initializes the processor's state after power up. A dedicated logic unit asserts PORESET input for a period long enough to cover the MPC8349 core voltage stabilization. When the MPC8349E MDS Processor Board is working in Stand-Alone Mode or PIB Combined Mode, a Power-On-Reset may be generated manually as well by an on-board dedicated push-button (SW1).

In addition, a power on reset for the MPC8349 can be done by toggling bit #7 in BCSR7.

5.1.2 Hard Reset

Hard-Reset may be generated on the MPC8349E MDS Processor Board by any one of the following sources:

- COP/JTAG Port (in Stand-Alone Mode only)
- Manual Hard reset.
- Internal sources.

Hard-Reset, when generated, causes the MPC8349 to reset all its internal hardware except for PLL logic and re-acquires the Hard-reset configuration from its current source. Since hard-reset also resets the refresh logic for dynamic RAMs, their content is lost as well.

CAUTION

HRESET is an open-drain signal and must be driven with an open-drain gate by whatever external source is driving it. Otherwise,

contention will occur over that line, and that might cause permanent damage to either board logic and/or to the MPC8349.

5.1.2.1 COP/JTAG Port Hard - Reset (stand-alone only)

To provide convenient hard-reset capability for a COP/JTAG controller, an HRESET line has been connected to the COP/JTAG port connector. The COP/JTAG controller may directly generate a hard-reset by asserting (low) this line.

5.1.2.2 Manual Hard Reset

To allow a run-time Hard-reset, a manual Hard-reset is facilitated, via SW8. Note that this cannot be done when the MPC8349E MDS Processor Board is connected in a PC (Agent Mode), but instead SW1 can be used.

In addition, a manual hard reset for the MPC8349 can be done by toggling bit #4 in the CCR register.

5.1.2.3 Manual Soft Reset

To allow a run-time Soft-reset, manual Soft-reset is facilitated, via SW9. Note that this cannot be done when the MPC8349E MDS Processor Board is connected in a PC (Agent Mode).

In addition, a manual hard reset for the MPC8349 can be done by toggling bit #5 in the CCR register.

5.2 Board Control & Status Registers – BCSR

The BCSR is an 8-bit wide read / write register file that controls or monitors most of the MPC8349E MDS Processor Board hardware options. The BCSR's register may be accessed from the Local Bus or via the FPGA internal JTAG controller. The BCSR includes up to 16 registers, some of which are optional.

BCSR registers are duplicated numerous times within a CS1 region. This is due to the CS region's 32KB minimum block size and the fact that only address lines A[28:31] are decoded for register selection by the BCSR. BCSR is implemented on a Xilinx FPGA device that provides register and logic functions over some MPC8349E MDS Processor Board signals.

The BCSR controls or monitors the following functions:

1. Power-on-Reset & Hardware configuration setting for the processor.
2. Most of the Hardware Reset Configuration bits are stored in BCSR registers available from the Local Bus or JTAG.
3. Hard- Soft- Reset and NMI (IRQ) pushbuttons debounce function.
4. Hardware Configuration for the both GETH transceivers.
5. Enable/Disable to:
 - Two GETH1,2 Transceivers.

- Dual RS232 Transceiver.
 - PSRAM (if installed) or FLASH select.
 - SHMOO function.
 - LED off.
6. BCSR provides h/w write protection for FLASH and BRD I2C EEPROM .
 7. Two LEDs (one green, one red) provide s/w signaling.
 8. Special CCR - COP register for JTAG port connectivity.
 9. Status registers BCSR10, BCSR11 include:
 - PCI Host Mode indicates if the Board is working in a Host Mode (Stand-Alone or PIB Combined) or the Agent Mode
 - Processor Low Power Mode (QUISCE)
 - Software Option Identification (set by SW2 Rotary Switch)
 - BCSR Revision code

Sections of the BCSR slice control registers generally have **low** active notations. This means that a bit function will be realized while the bit is zero. When a bit is set to **high** a related function is disabled. The default setting is assumed to be non-functional. The most significant bit is bit 0.

5.2.1 BCSR0 - Board Control / Status Register 0

The BCSR0 serves as a 8-bit control register on the board The BCSR0 may be read or written at any time. BCSR0 defaults are attributed immediately after a Power-On Reset or HRESET. BCSR0 fields are described below in Table 5-1.:

Table 5-1. BCSR0 Description (Offset 0)

BIT	MNEMONIC	Function	Default upon HRST	Attr.
0	GETH1EN	GETH Transceiver 1 Enable. Upon activation (low), the MPC8349 TSEC port 1 transceiver is enabled. When negated (high), the GETH Transceiver enters standby mode. May be rewritten via JTAG/LBIU.	0	R,W
1	GETH2EN	GETH Transceiver 2 Enable. Upon activation (low), the MPC8349 TSEC port 1 transceiver is enabled. When negated (high), the GETH Transceiver enters standby mode. May be rewritten via JTAG/LBIU.	0	R,W
2	GETHRST	GETH Transceiver Reset. The GETH devices are reset when the GETHRST is asserted (low). The Board Hard Reset signal of the MPC8349 resets GETH devices. May be rewritten via JTAG/LBIU.	1	R,W
3	RS232EN	UART Ports Transceivers Enable. Upon activation (low), the Dual RS232 Transceiver, using the UART ports of the MPC8349, is enabled. When negated (high), the RS232 Transceiver enters standby mode. May be rewritten via JTAG/LBIU.	0	R,W

Table 5-1. BCSR0 Description (Offset 0)

BIT	MNEMONIC	Function	Default upon HRST	Attr.
4	BOOTWP	BOOT I2C EEPROM Protect. When asserted (low) BOOT EEPROM functions normally, when negated (high) write operations are disabled. May be rewritten via JTAG/LBIU.	1	R,W
5	SIGNAL0	Signal LED 0. A dedicated Green LED is illuminated when SIGNAL0 is active (low). The LED is unlit when it is in an inactive (default) state (high). During the Reset Configuration sequence the LED indicates the SRESET assertion. The user may utilize the LED for software Slave signalling purposes. May be rewritten via JTAG/LBIU.	1	R,W
6	SIGNAL1	Signal LED Slave 1. A dedicated Red LED is illuminated when SIGNAL1 is active (low). The LED is unlit when it is in an inactive (default) state (high). During the Reset Configuration sequence the LED indicates the HRESET assertion. May be rewritten via JTAG/LBIU.	1	R,W
7	SPARE07	Not Implemented.	1	R,W

5.2.2 BCSR1 - Board Control / Status Register 1

On the board, the BCSR1 acts as a control register. The BCSR1, which may be read or written at any time, receives its defaults immediately after Power-On or PORESET. The BCSR1 fields are described below in Table 5-2.:

Table 5-2. BCSR1 Description (Offset 1)

BIT	MNEMONIC	Function	Defn.	Attr.
0	CFG_CLKIN_DIV	CLKIN Division. The bit reflects CFG_CLKIN_DIV signal logic level during Power Reset Configuration sequence. The bit is set by default by appropriate DIP switch SW3.4. May be rewritten via JTAG/LBIU.	SW3.4 Sampled at Power ON	R,W
1-3	CFG_RS[0:2]	Reset Configuration Words Source. The bits reflect CFG_RS[0:2] signals logic level during PON Reset Configuration sequence. The bits are set by default by appropriate DIP switch SW3.1-3. May be rewritten via JTAG/LBIU.	SW3.1-3 Sampled at Power ON	R,W
4-6	ROMLOC[0:2]	Boot ROM interface location. The bits reflect ROMLOC[0:2] signals logic level during Reset Configuration sequence. The bits are set by default by appropriate DIP switch SW6.3-5. May be rewritten via JTAG/LBIU.	SW5.3-5 Sampled at PORESET neg.	R,W

Table 5-2. BCSR1 Description (Offset 1)

BIT	MNEMONIC	Function	Defn.	Attr.
7	FLASHPRT	Flash Protect. Upon activation (low) the Flash may be written. When high the write protection is set.	1 Sampled at PORESET neg.	R,W

5.2.3 BCSR2 - Board Control / Status Register 2

On the board, the BCSR2 acts as a control register. The BCSR2, which may be read or written at any time, receives its defaults immediately after the PORESET signal. The BCSR2 fields are described below in Table 5-3.:

Table 5-3. BCSR2 Register Description (Offset 2)

BIT	MNEMONIC	Function	Default upon PORESET	Attr.
0-3	SPMF[0:3]	System PLL Multiplication Factor. The four bits reflect SPMF[0:3] signals logic level during Hard Reset Configuration sequence. The bits are set by default by appropriate DIP switch SW3.5-8. May be rewritten via JTAG/LBIU.	SW3.5-8	R,W
4-5	SVCOD[4:5]	VCO Division. The two bits reflect SVCOD[4:5] signals logic level during Hard Reset Configuration sequence. The bits are set low by default. May be rewritten via JTAG/LBIU.	0	R,W
6-7	BOOTSEQ[6:7]	Boot Sequencer Configuration. The two bits reflect BOOTSEQ[6:7] signals logic level during Reset Configuration sequence. The bits are set by appropriate DIP switch SW5.1-2. May be rewritten via JTAG/LBIU.	SW5.1-2	R,W

5.2.4 BCSR3 - Board Control / Status Register 3

On the board, the BCSR3 acts as a control register. The BCSR3, which may be read or written at any time, receives its defaults immediately after the PORESET signal. The BCSR3 fields are described below in Table 5-4.:

Table 5-4. BCSR3 Register Description (Offset 3)

BIT	MNEMONIC	Function	Default upon PORESET	Attr.
0-6	COREPLL[0:6]	Core PLL Multiplication Factor. The seven bits reflect COREPLL[0:6] signals logic level during Hard Reset Configuration sequence. The bits are set by default by appropriate DIP switch SW7.1-7. May be rewritten via JTAG/LBIU.	SW7.1-7	R,W
7	SWEN	Software Watchdog Enable. The bit reflect SWEN signals logic level during Hard Reset Configuration sequence. The bit are set by default by appropriate DIP switch SW6.8. May be rewritten via JTAG/LBIU.	SW6.8	R,W

5.2.5 BCSR4 - Board Control / Status Register 4

On the board, the BCSR4 acts as a control register. The BCSR4, which may be read or written at any time, receives its defaults immediately after PORESET signal. The BCSR4 fields are described below in Table 5-5.:

Table 5-5. BCSR4 Description (Offset 4)

BIT	MNEMONIC	Function	Default upon PORESET	Attr.
0	PCIHOST	PCI Host Mode. If working as a PCI add-in card (Agent Mode), this bit is set low . When the MPC8349E MDS Processor Board is combined with the PIB (PIB combined mode), the PCIHOST bit will be high to set PCI processor's port as the host mode. May be rewritten via JTAG.	Defined by operating configuration	R,W
1	PCI64	PCI 64-bit Mode. The bit reflects PCI64 signal logic level during Hard Reset Configuration sequence. When it is low the PCI1,2 ports are 32-bit mode, if high the PCI1 port uses 64-bit I/F. The bit is controlled by the appropriate DIP switch SW4.7. May be rewritten via JTAG/LBIU.	SW4.7 DIP Switch	R,W
2	PCI1ARB	PCI1 Arbiter. If working in Agent Mode, this bit is set low to provide external arbiter. When the MPC8349E MDS Processor Board is working in the PIB Combined Mode, this bit is set high to configure the PCI1 port with an internal arbiter. May be rewritten any time via JTAG.	Defined by operating configuration	R,W

Table 5-5. BCSR4 Description (Offset 4)

BIT	MNEMONIC	Function	Default upon PORESET	Attr.
3	PCI2ARB	PCI2 Arbiter. If working in the Agent Mode, this bit is set low to provide an external arbiter. When the MPC8349E MDS Processor Board is working in the PIB Combined Mode, this bit is set high to configure the PCI2 port with an internal arbiter. May be rewritten any time via JTAG.	Defined by operating configuration	R,W
4	COREDIS	Core Disable. When high the e300 core is prevented from fetching boot code until configuration by an external master is complete. If low , the core runs normally. May be rewritten any time via JTAG.	Setup defined	R,W
5	BMS	Boot Mode. When low , sets lower 8MByte boot memory space location if used for DDR or PCI boot source. Otherwise (for LBIU boot source), the BMS will be high for upper boot memory space location. User may change boot source location by request. May be rewritten any time via JTAG/LBIU.	SW4.5	R,W
6	LBIUCM	Local Bus Clock Mode. When set high local bus memory controller operates with a frequency equal to twice the frequency of the <i>csb_clk</i> . If this bit is low , the local bus memory controller will operate at the <i>csb_clk</i> frequency. The DIP-switch SW6.7 may change LBIUCM bit setting. May be rewritten any time via JTAG/LBIU.	SW6.7	R,W
7	DDRCM	DDR SDRAM Clock Mode. If this bit set high , the DDR SDRAM memory controller operates with frequency equal to twice the frequency of the <i>csb_clk</i> . If this bit is low , the DDR SDRAM memory controller operates at the <i>csb_clk</i> frequency. The DIP-switch SW6.6 may change DDRCM bit setting. May be rewritten any time via JTAG/LBIU.	SW6.6	R,W

5.2.6 BCSR5 - Board Control / Status Register 5

On the board, the BCSR5 acts as a control register. The BCSR5, which may be read or written at any time, receives its defaults immediately after the PORESET signal. The BCSR5 fields are described below in Table 5-6.:

Table 5-6. BCSR5 Description (Offset 5)

BIT	MNEMONIC	Function	Default upon PORESET	Attr.
0-1	TSEC1M	TSEC port 1 Config Mode. Two bits select standard/reduced versus width and the protocol used by the TSEC1 controller. See Table 5-7. May be rewritten any time via JTAG/LBIU.	SW4.1-2	R,W
2-3	TSEC2M	TSEC port 2 Config Mode. Two bits select standard/reduced versus width and the protocol used by the TSEC2 controller. See Table 5-7. May be rewritten any time via JTAG/LBIU.	SW4.3-4	R,W
4	TSEC1MST	GETH1 Master Mode. If high GETH1 transceiver configures in Master Mode. Otherwise when low GETH1 transceiver operates as Slave. May be rewritten any time via JTAG/LBIU.	1	R,W
5	TSEC2MST	GETH2 Master Mode. If high GETH2 transceiver configures in Master Mode. Otherwise when low GETH2 transceiver operates as Slave. May be rewritten any time via JTAG/LBIU.	1	R,W
6	INT_USB	Internal USB phy. If high on-board USB phy is tied to USB port 0 MPC8349. When working in the PIB Combined Mode, the INT_USB bit initiates low to select off-board USB phys and disable on-board USB phy. Wrong programming in PIB Combined Mode may cause USB digital signals contention.	0 - for combined mode; 1 - for other modes	R,W
7	SPARE5	Not Implemented.	11	-

Table 5-7. TSEC Port Mode

Setting Value	TSEC Mode
00	The TSEC controller operates in the RGMII protocol, using only four transmit data signals and four receive data signals.
01	The TSEC controller operates in the RTBI protocol, using only four transmit data signals and four receive data signals.
10	The TSEC controller operates in the GMII protocol, using eight transmit data signals and eight receive data signals.

Setting Value	TSEC Mode
11	The TSEC controller operates in the TBI protocol, using eight transmit data signals and eight receive data signals.

5.2.7 BCSR6 - Board Misc. Register 1

On the board, the BCSR6 acts as a control register. The BCSR6, which may be read or written at any time, receives its defaults immediately after PORESET signal. The BCSR6 fields are described below in Table 5-8..

Table 5-8. BCSR6 Description (Offset 6)

BIT	MNEMONIC	Function	Default upon PORESET	Attr.
0	SPARE60	Not implemented.	N/A	R,W
1	TPR	Test Port Enable. Should be set high to place the processor in Test Mode. When low the processor operates in normal mode. May be rewritten any time via JTAG.	0	R,W
2	TLE	True Little Endian. Low selects Big Endian Mode. High value provides Little Endian Mode. May be rewritten any time via JTAG.	0	R,W
3	LALE	Local Bus Timing. When bit sets high LALE has earlier negation. Low provides normal LALE timing. May be rewritten any time via JTAG.	0	R,W
4	JTAG2SEL	JTAG Chain Select. Select JTAG chain for external devices on PMC cards when high . Low provides JTAG normal configuration.	0	R
5-7	SPARE65-7	Not Implemented.	'111'	-

5.2.8 BCSR7 - Board Misc. Register 2

On the board, the BCSR7 acts as a control register. The BCSR7, which may be read or written at any time, receives its defaults immediately after PORESET signals. The BCSR7 fields are described below in Table 5-9..

Table 5-9. BCSR7 Description (Offset 7)

BIT	MNEMONIC	Function	Default upon PORESET	Attr.
0	TESTEN	Enable Chip Test Mode. For Internal use only. May be rewritten any time via JTAG.	0	R,W
1	LEDEN	LEDs Enable. All LEDs remain darkened for Failure Analysis purposes when set high . When low , the LEDs behave normally according to Section 4.2 "LEDs". May be rewritten any time via JTAG/LBIU.	0	R,W
2	SHMOOEN	SHMOO Test Enable . An enable signal to allow programming of the Internal Core Power Supply and the application of an external clock from the PIB Board when low . May be rewritten any time via JTAG/LBIU.	1 Set at Power On	R,W
3	EM	FLASH Emulation (PSRAM). Low enables PSRAM accesses to provide Flash emulation. When high PSRAM is disabled, Flash may be enabled instead. May be rewritten any time via JTAG/LBIU.	1	R,W
4	FLEN	FLASH Enable. Low enables Flash accesses. When high Flash operation is not available, PSRAM part may be enabled instead. May be rewritten any time via JTAG/LBIU.	0	R,W
5	BUFFEN	Expansion Buffer Enable. Low enables access to the PIB for the PIB combined mode. High level sets off the expansion buffer for the stand alone mode. May be rewritten any time via JTAG/LBIU.	Setup defined at Power On	R,W
6	BRDWP	BRD Write Protect. When high the BRD EEPROMs on the MPC8349E MDS Processor Board are hardware protected for write operation. Low level allows the content of the BRDs to be updated. May be rewritten any time via JTAG/LBIU.	1 Set at HRST	R,W
7	PORESET	Power-On-Reset. Toggling low-high within 1ms time window will generate a PORESET negative pulse on the MPC8349E MDS Processor Board. May be rewritten any time via JTAG/LBIU.	1	R,W

5.2.9 BCSR8 - Board Misc. Register 3

On the board, the BCSR8 acts as a control register. The BCSR8, which may be read or written at any time, receives its defaults immediately after PORESET. The BCSR8 fields are described below in Table 5-10.

Table 5-10. BCSR8 Description (Offset 8)

BIT	MNEMONIC	Function	Defn.	Attr.
0	CNFLOCK	Config Bit Lock. When low BCSR contents don't update during PORESET. High provides normal operation when BCSR default value is set according DIP switches. Used for debug purpose. May be rewritten any time via JTAG.	1 Set at Power On	R,W
1-7	SPARE8	Not Implemented.	'1111111'	R,W

5.2.10 BCSR10 - Board Status Register 1

The BCSR10 is a read-only status register. The BCSR10 fields are described below in Table 5-11..

Table 5-11. BCSR10 Description (Offset 0xA)

BIT	MNEMONIC	Function
0	PCI_HOST	PCI_HOST. Indicates the board's working mode. This is high when installed in a PC (Agent Mode), and low when in Stand-Alone or PIB Combined Mode.
1	QUISCE	QUISCE Status. Allows the processor to determine the power down mode when bit is low by reading via JTAG. If the bit is high , the power down mode is determined by internal processor logic, regardless of JTAG settings.
2-4	SWOP	Software Option Three-bit code reading from the SW2 switch.
5	FCFG	FLASH Configuration. When high and configuration source set as Local Bus (BCSR1.1-3 = 0) the RCW is loaded from FLASH, if low , the RCW is loaded from the BCSR.
6-7	-	Not Implemented.

5.2.11 BCSR11 - Board Status Register 2

The BCSR11 Register is a status register accessed from the Local Bus. The BCSR11 fields are described below in Table 5-12..

Table 5-12. BCSR11 Description (Offset 0xB)

BIT	MNEMONIC	Function	Attr.
0-3	REV	BCSR Revision. Four most significant bits revision coding	Programmed value
4-7	SubREV	BCSR Revision. Four least significant bits revision coding	Programmed value

Table 5-13. BCSR Revision Coding

Revision Number [0:3]	Board Revision
0.x	Proto
	Pilot
1.x	RevA

5.2.12 CCR - COP Control Register

CCR - COP Control Register is a service register accessed from the Local Bus. It is a part of PCI2JTAG converter for the Agent Mode (when the Processor Board is plugged into a PC). The CCR fields are described below in Table 5-14.

Table 5-14. CCR Description (Offset 0xF)

BIT	MNEMONIC	Function	Default upon PORESET	Attr.
0	TDI	TAP Data Input. Drive serial Data into COP port.	Disabled	W
	TDO	TAP Data Output. Read serial Data from COP port.	Disabled	R
1	TCK	TAP Clock. When asserted (low), TAP clock is enabled, and driven into the COP port. If negated (high), TAP clock is disabled.	Disabled	W
2	TMS	TAP Mode Select. Drive TMS signal into COP port.	Disabled	W
3	TRST	TAP Reset. Reset TAP controller of COP port.	Disabled	W
4	HRESET	Hard Reset. Low provides short negative HRST pulse on the board.	Disabled	W

Table 5-14. CCR Description (Offset 0xF)

BIT	MNEMONIC	Function	Default upon PORESET	Attr.
5	SRESET	Soft Reset. Low provides short negative SRST pulse on the board.	Disabled	W
6	CKSTPI	Check Stop. Causes Machine Check Stop of the processor.		W
7	COPEN	CCR COP Enable. Low permits access to processor JTAG port via CCR register. High disables the CCR register.	1	W

5.3 External Connections

5.3.1 P1 - MiniAB USB Connector

MiniAB USB connector pinout is shown in Table 5-15. "P1-MiniAB USB Connector" below. This connector is used for connectivity to external devices USB1.1/USB2.0/OTG. It is accessible from the front panel of the board (see **Figure 1-1** for location).

Table 5-15. P1-MiniAB USB Connector

Pin No.	Signal Name	Description
1	Vbus	5V Power for USB - Power is generated internally if working in PCI mode or is supplied from a cable (in stand-alone mode) while the USB controller configures the device
2	DM	Differential Negative Data
3	DP	Differential Positive Data
4	ID	Identification Signal for Host/Device Mode Setting (PCI mode vs. stand-alone mode)
5	GND	Ground

5.3.2 P2 - DUART Port

The DUART port connector - P2 is implemented with a 90°, 10-pin, RJ45 connector, signals of which are described in Table 5-16.

Table 5-16. P2 DUART Signals

Pin No.	Signal Name	UART Port	Attr.	Description
1	CTS1	1	I	Clear To Send
2	RXD1		I	Receive Data
3	TXD1		O	Transmit Data
4	RTS1		O	Ready To Send
5,10	GND		P	Ground.
6	CTS2	2	I	Clear To Send
7	RXD2		I	Receive Data
8	TXD2		O	Transmit Data
9	RTS2		O	Ready To Send

For connection to regular D-Type-9 RS232 cable use special cable from MPC8349E MDS Processor Board set.

5.3.3 Logic Analyzer Connectors

P3, P6, P7, and P8 are 38-pin, SMT, high density, matched impedance connectors made by AMP and used for Logic Analyzer measurements. They contain all MPC8349 signals, except for the DDR signals.

5.3.4 P5 - SMB Connector

RF Subminiature Coaxial Connector P5 is used to connect an external clock to the MPC8349, which is enabled only when jumper JP1/2-3 is closed. Optional.

5.3.5 P9 - Debug COP Connector

P9 is a Freescale-standard JTAG/COP connector for the PowerPC. It is a 16 pin 90° two row header connector with key. During debug, all processors connected by the JTAG chain may be accessed through connector P9. The pinout of P9 is shown in Table 5-17. "P9 - JTAG/COP Connector" below:

Table 5-17. P9 - JTAG/COP Connector

Pin No.	Signal Name	Attr.	Description
1	TDOc	I	Transmit Data Output. This is the MPC8349 JTAG serial data output driven by Falling edge of TCK.
2,10,12,16	GND	P	Main GND plane.

Table 5-17. P9 - JTAG/COP Connector

Pin No.	Signal Name	Attr.	Description
3	TDIc	O	Transmit Data In. This is the JTAG serial data input of the MSC8101, sampled on the rising edge of TCK.
4	nTRSTc	O	Test port Reset. When this signal is active (Low), it resets the JTAG logic. This line is provides a pull-down on the ADS with a 4.7K Ω resistor, which provides a continuous reset of the JTAG logic, when connector is unplugged.
5	N.C.	-	Not Connected.
6	SENSE	P	Connect to 3.3V power supply bus via protection resistor. May be used for Command Convertor power.
7	TCKc	O	Test port Clock. This clock shifts in / out data to / from the JTAG logic. Data is driven on the falling edge of TCK and is sampled both internally and externally on its rising edge.
8	Check Stop Input	I	Machine Check Stop Input
9	TMSc	O	Test Mode Select. This input selects test mode and is sampled on the rising edge of TCK. This line is qualified with TCK in a same manner as TDI, and changes the state of the JTAG machines. This line is pulled up internally by the MPC8349.
11	nSRSTc	I/O,P.U.	When asserted by an external H/W, generates Soft-Reset sequence for the MPC8349. Pulled Up on the ADS using a 4.7K Ω resistor. When driven by an external tool, MUST be driven with an Open Drain gate. Failure to do so might result in permanent damage to the processor and / or to ADS logic.
13	nHRSTc	I/O,P.U.	When asserted by an external H/W, generates Hard-Reset sequence for the MPC8349. Pulled Up on the ADS using a 4.7K Ω resistor. When driven by an external tool, MUST be driven with an Open Drain gate. Failure to do so might result in permanent damage to the processor and / or to ADS logic.
14	KEY	-	No pin in connector. Serves for correct plug insertion. See Figure 5-1 for location.
15	Check Stop Output	O	Machine Check Stop Output

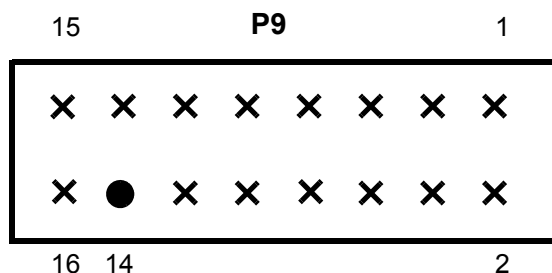

Figure 5-1 P9 COP connector front view

5.3.6 P10 - FPGA's In-System-Programming (ISP)

This is a 16 pin generic 0.100" pitch header connector, providing In System Programming capability for on board programmable logic devices by Xilinx FPGA (Spartan-2E). The pinout of P10 is shown in Table 5-18. "P10 - FPGA Programming ISP Connector" below:

Table 5-18. P10 - FPGA Programming ISP Connector

Pin No.	Signal Name	Attr.	Description
1	ISP_TDO	I	Transmit Data Output.
2,10,12,16	GND	P	Main GND plane.
3	ISP_TDI	O	Transmit Data In.
4,5,8,11,13,14,15	N.C.	-	Not Connected.
6	SENSE	P	Connect to 3.3V power supply bus via protection resistor. Use for programmer powering.
7	ISP_TCK	O	Test port Clock.
9	ISP_TMS	O	Test Mode Select.

5.3.7 P11 - Power Connector

P11 is 2mm Power Jack RAPC722 which provides a connection to an external power supply +5DC@2.5A.

5.3.8 J1,J2 - Ethernet Port Connector

The Ethernet connectors on the MPC8349 (J1,J2) are both Twisted-Pair (1000-Base-T) compatible connectors. They are implemented with a 90°, 8-pin, RJ45 Combo connector with internal magnetics and two LEDs (indicating communication speed), signals of which are described in Table 5-19. "J1,J2 - Ethernet Port Interconnect Signals" below. These connections are on the front panel. For location, see Table 1-1. Green LED indicates 1000Mbit Data rate, Yellow LED is lit when 100Mbit Data rate mode. .

Table 5-19. J1,J2 - Ethernet Port Interconnect Signals

Pin No.	Wire Color	10Base-T/100Base-T Signal	1000 Base-T Signal
1	White	Twisted-Pair Transmit Data positive output	BI-DA+
2	White-Orange	Twisted-Pair Transmit Data negative output .	BI-DA-
3	White-Green	Twisted-Pair Receive Data positive input .	BI-DB+n
4	Blue	Unused	BI-DC+
5	White-Blue	Unused	BI-DC-
6	Green	Twisted-Pair Receive Data negative input	BI-DB-
7	White-Brown	Unused	BI-DD+
8	Brown	Unused	BI-DD-



6

Clocking for the MPC8349E MDS Processor Board

This chapter describes the clocking and timing of the MPC8349 while being used on the MPC8349E MDS Processor Board.

Two primary clock sources are available for the MPC8349: CLKIN or PCICLK, depending on whether the device is a Host (that is, in Stand-Alone or PIB Combined Mode) or working in the Agent Mode (inserted in a PC compatible computer).

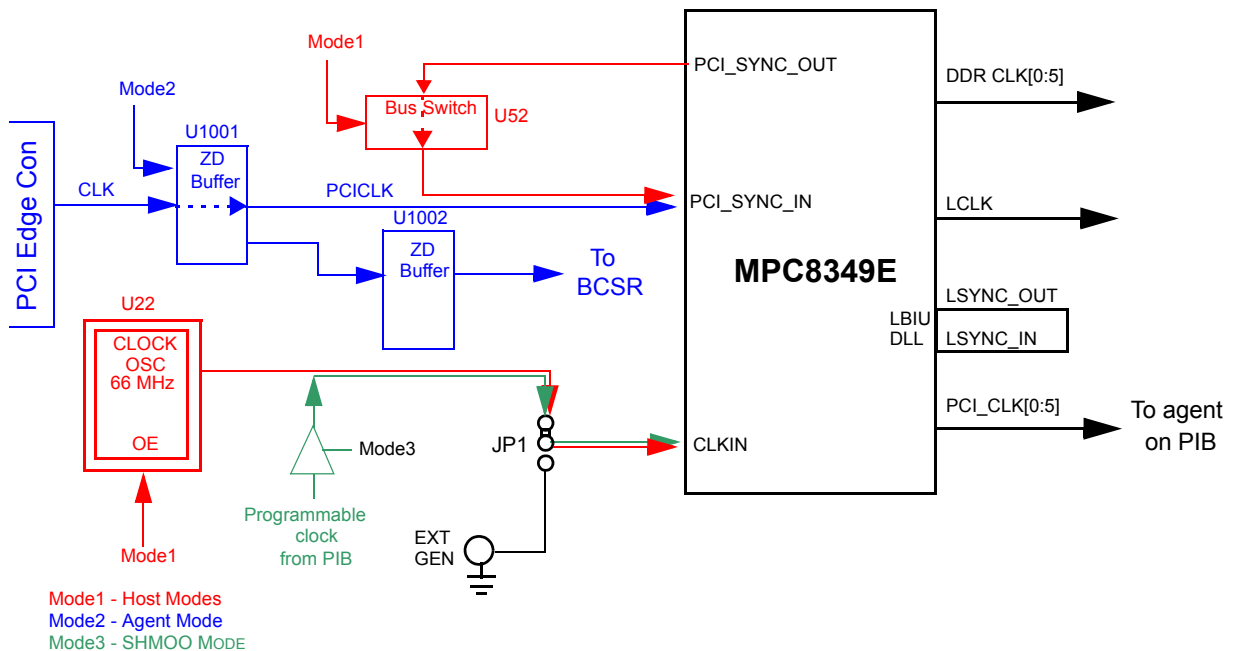

Figure 6-1 Clocking Scheme

6.1 MPC8349 as Host Device

When the MPC8349 is a Host device (Stand-Alone or PIB Combined Mode), CLKIN is its primary input clock. See the red colored lines and circuits in **Figure 6-1**.

The MPC8349 supports eight PCI_CLK output signals (not to be confused with the PCICLK signals, which are only used in the Agent Mode). These are divided into three groups. Each group can be independently configured to provide the output clock as equal to, or half of the frequency of CLKIN. Six of these PCI_CLK clocks are used by the ADS for clocking agent cards that are

plugged into the PIB.

CLKIN directly feeds the PCI_CLK output clocks dividers, and is also driven out on the PCI_SYNC_OUT pin for de-skewing of the external PCI_CLK clocks with the CLKIN signal.

Since the PIB uses a programmable clock synthesizer, this clocking mode will be preferable for chip verification. To provide more flexibility, an external pulse generator (EXT GEN) may be used via an SMB Hi-Frequency connector.

6.2 MPC8349 as Agent

When the MPC8349 is working in the Agent Mode (installed in a PC), the MPC8349 is synchronized with the clock from the Host (PC as default) via the PCI edge connector. This clock is designated by PCICLK in Figure 6-1 (see the blue colored lines and circuits).

Note that on the MPC8349 chip, only the PCI-1 port can work in Agent Mode; the PCI-2 port cannot. If, when this mode is activated, the PCI ports were found to be operating as a host, the clock switch turns to position 1, so that the input clock to the MPC8349 is driven by the clock received via the PCI edge connector.

Replacing Devices

This chapter provides instructions on replacing various devices on the MPC8349E MDS Processor Board.

7.1 Replacing Flash Memory

To remove the flash memory, follow the instructions below in **Figure 7-1** to **Figure 7-4** below (in that order). Note that the flash memory can be changed no more than 50 times.

To replace the flash memory, follow the instructions in **Figure 7-4** to **Figure 7-1** (in that order), then secure the casing as shown in **Figure 7-5**.

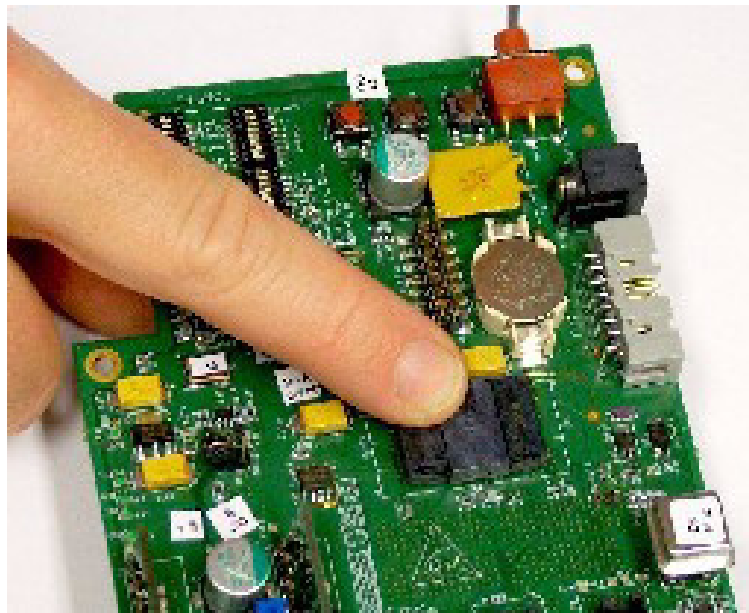

Figure 7-1 Flash Memory - push to dislodge casing

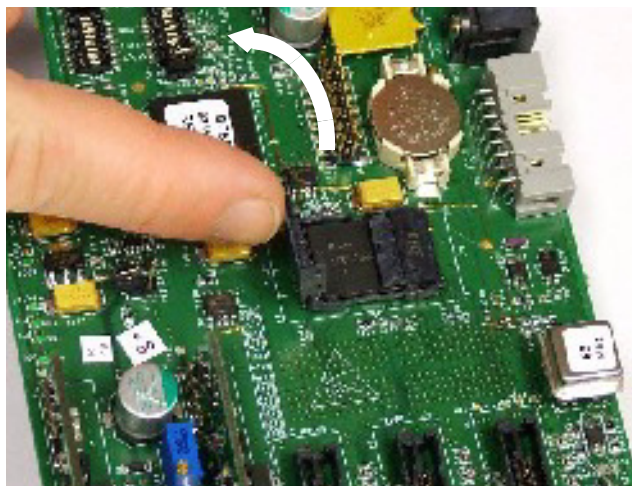

Figure 7-2 Flash Memory - open casing

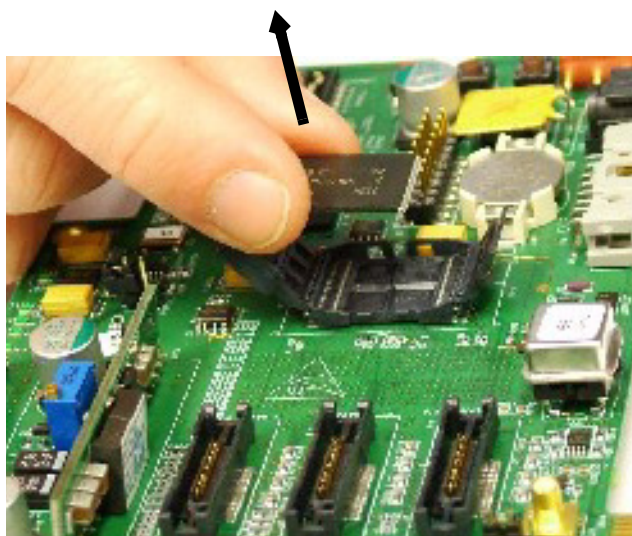

Figure 7-3 Flash Memory - remove memory unit

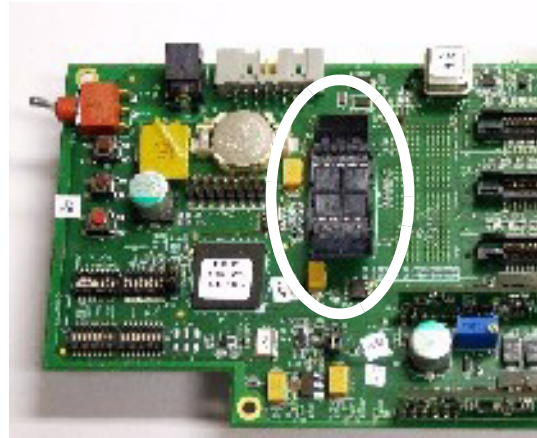

Figure 7-4 Flash Memory - unit removed

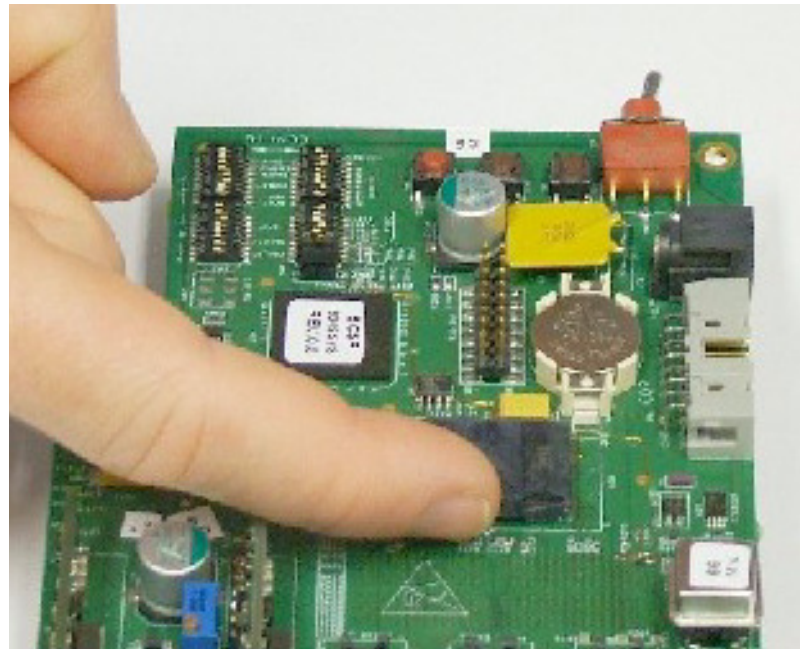

Figure 7-5 Flash Memory - replacing unit (push in until “click” is heard)

7.1.1 Cleaning Flash Memory

If there is some decrease in performance from the flash memory unit, the socket may need to be cleaned. Do this by dipping a tooth pick dipped in isopropyl alcohol, and gently removing any residual debris from the flash memory socket.

7.2 Replacing SODIMM units

To remove or replace the SODIMM units, follow the instructions in **Figure 7-6** through **Figure 7-9**, in that order.

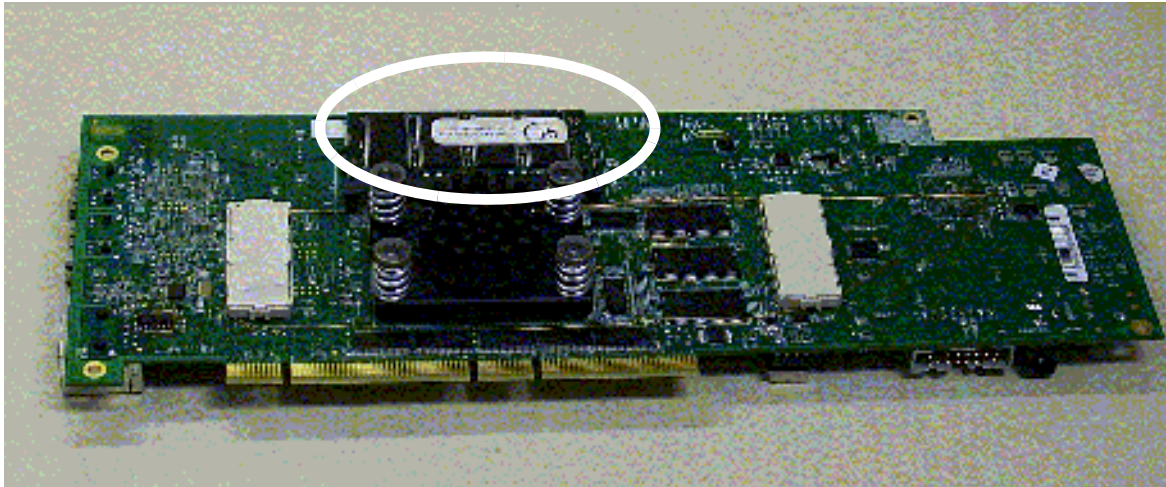

Figure 7-6 SODIMM Memory - Location on underside of board

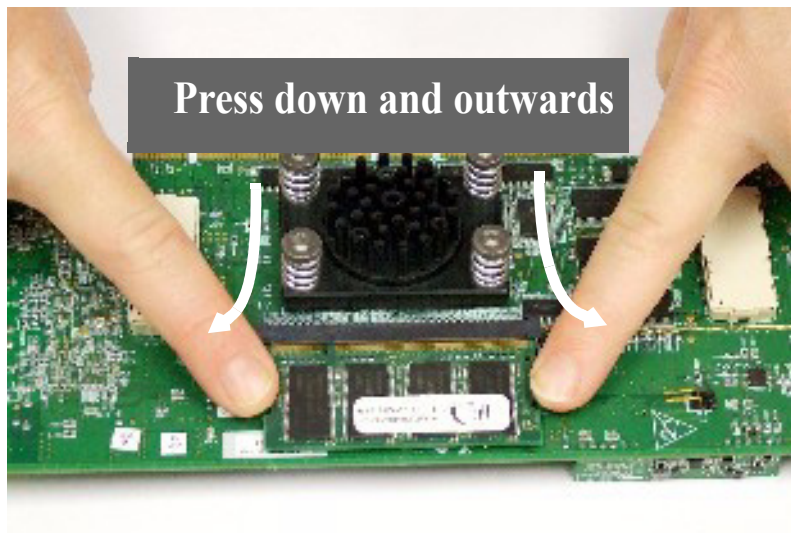

Figure 7-7 SODIMM Memory - release retaining clips

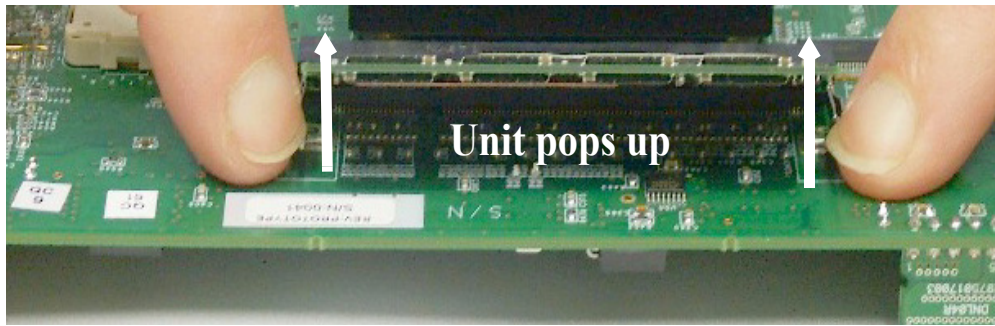

Figure 7-8 SODIMM Memory - release unit

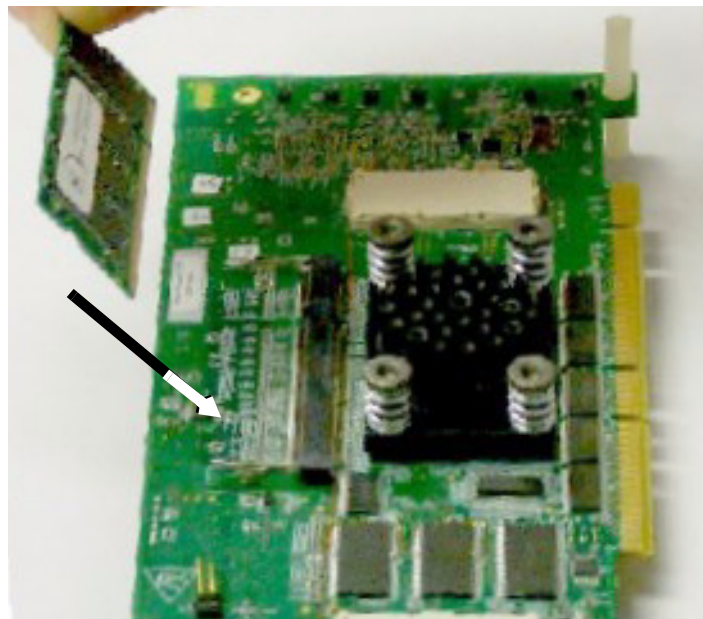

Figure 7-9 SODIMM Memory - remove unit

7.3 Replacing MSC8349E Processor

To remove the MSC8349E processor, follow the instructions in **Figure 7-10** to **Figure 7-19** below.

To replace the MSC8349E processor, follow the instructions in **Figure 7-19** to **Figure 7-10** below (in that order).

Note that the Allen wrench is provided in the tool kit.

When replacing the framework of the chip, make sure that it is properly aligned as shown in **Figure 7-18**. Incorrect alignment is shown in **Figure 7-19**.

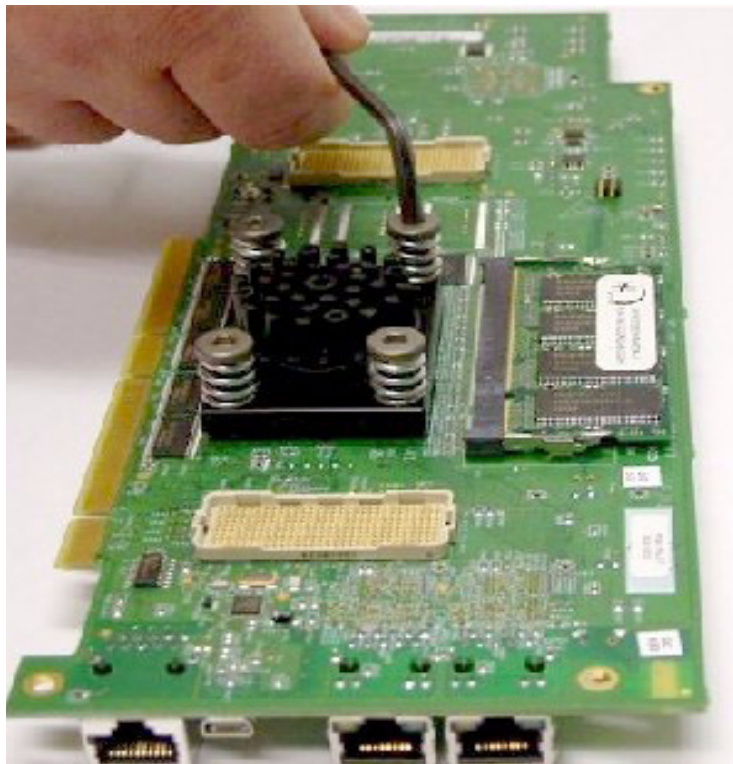

Figure 7-10 Loosen Allen screws

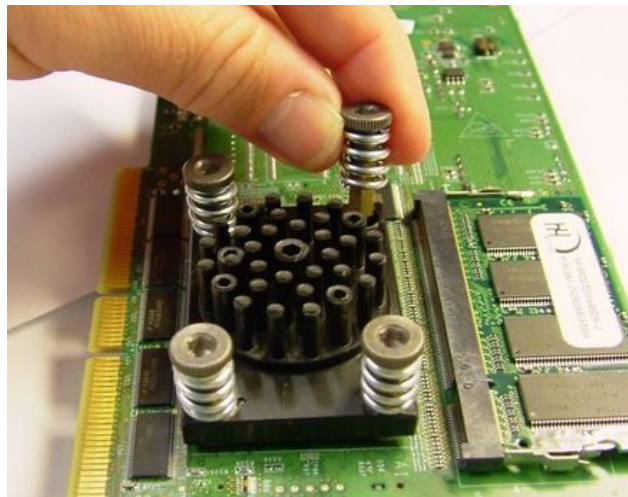

Figure 7-11 Remove Allen screws by hand



Figure 7-12 Allen screws removed

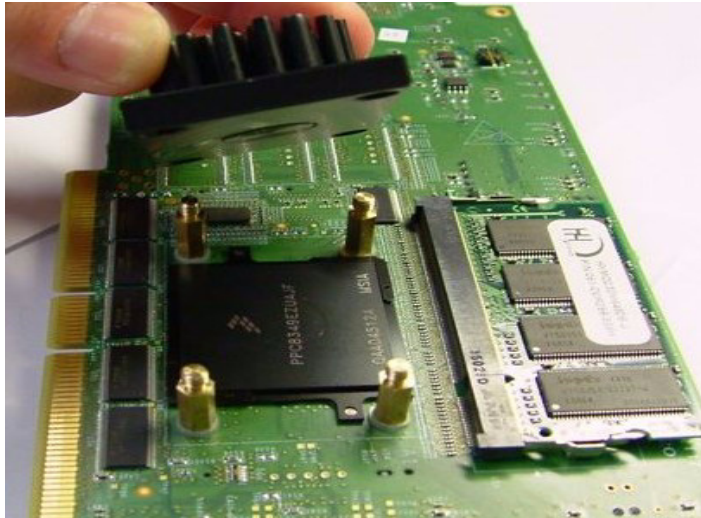

Figure 7-13 Remove heat sink



Figure 7-14 Heat sink removed

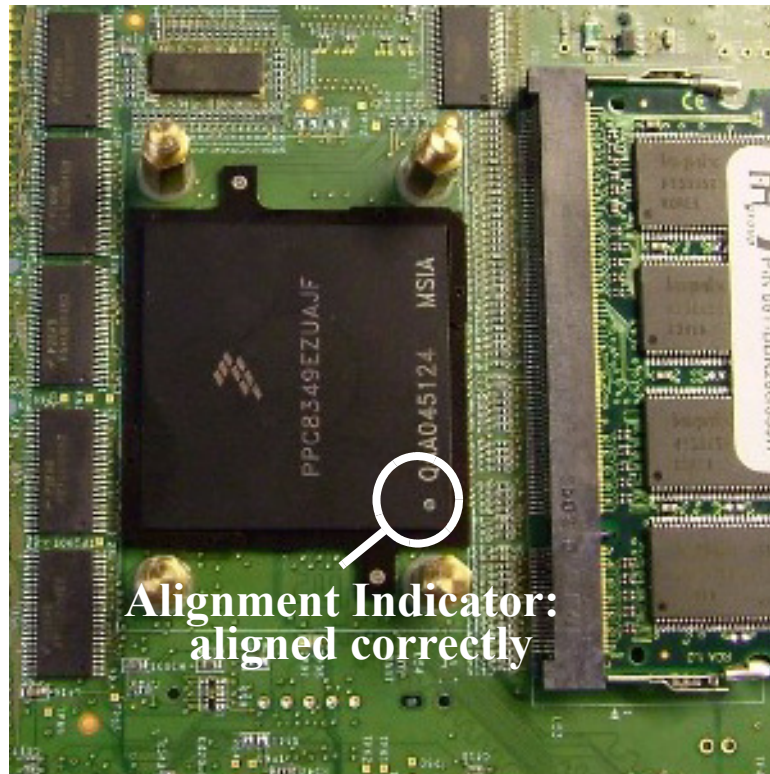

Figure 7-15 Chip alignment: Correct

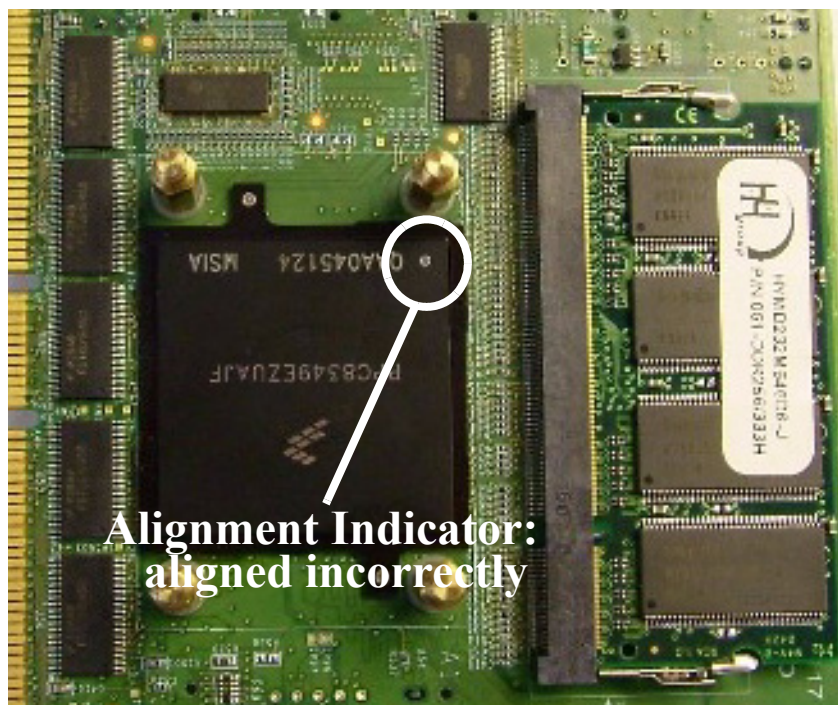

Figure 7-16 Chip alignment: Incorrect

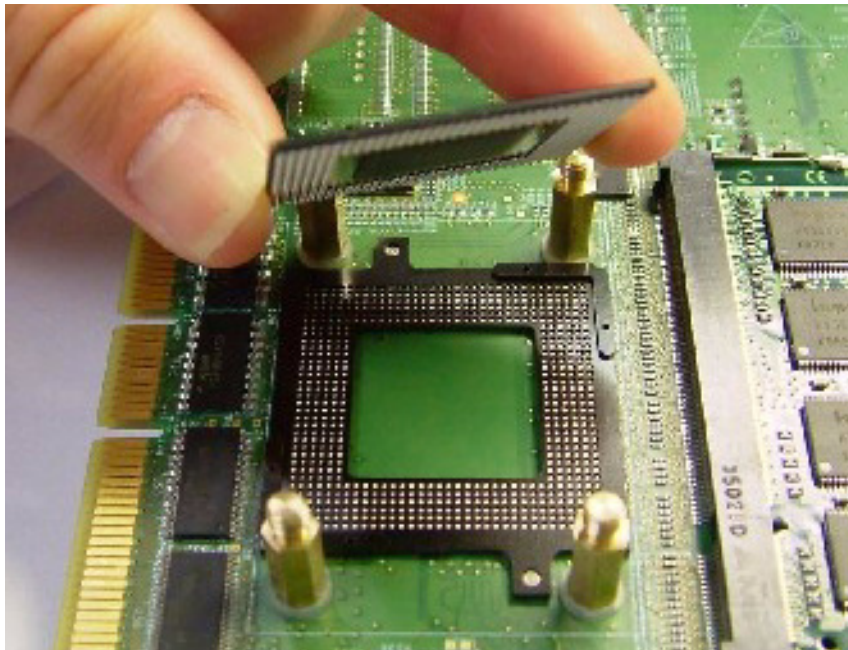

Figure 7-17 Remove chip

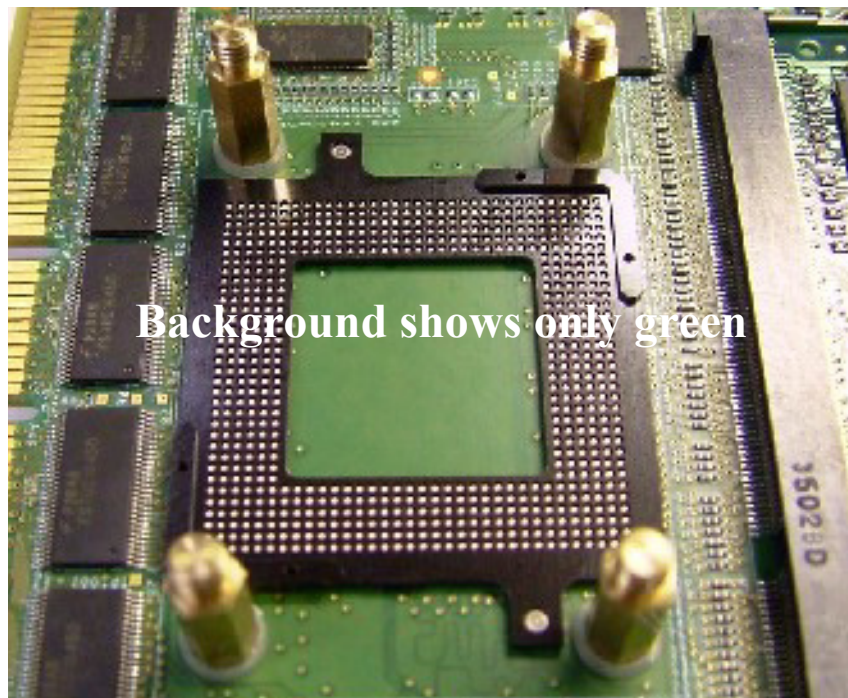

Figure 7-18 Chip framework alignment: correct

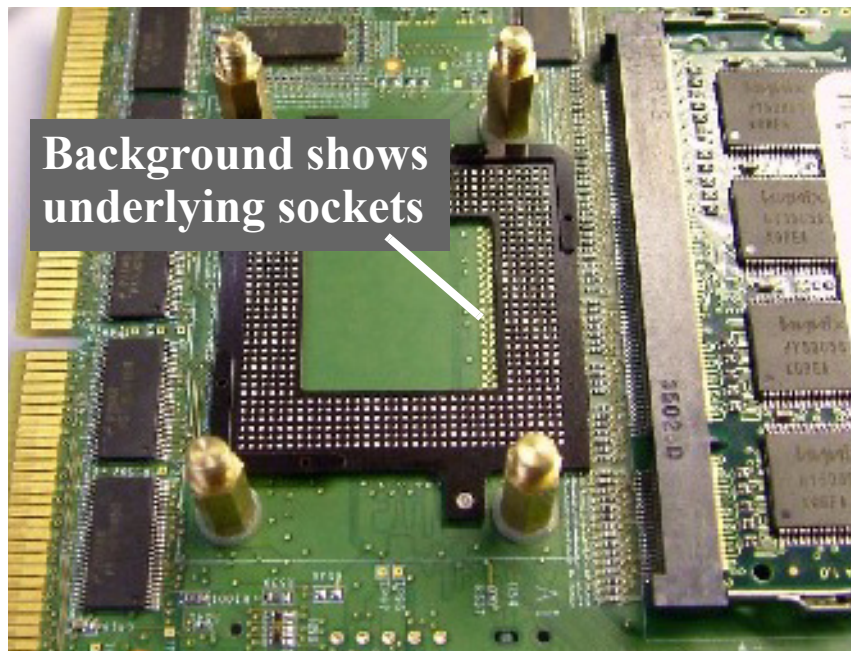

Figure 7-19 Chip framework alignment: incorrect

