



# CodeWarrior Development Studio IDE 5.9 User's Guide

Revised: 12 September 2011





Freescale™ and the Freescale logo are trademarks of Freescale Semiconductor, Inc. CodeWarrior is a trademark or registered trademark of Freescale Semiconductor, Inc. in the United States and/or other countries. All other product or service names are the property of their respective owners.

Copyright © 2004–2011 Freescale Semiconductor, Inc. All rights reserved.

Information in this document is provided solely to enable system and software implementers to use Freescale Semiconductor products. There are no express or implied copyright licenses granted hereunder to design or fabricate any integrated circuits or integrated circuits based on the information in this document.

Freescale Semiconductor reserves the right to make changes without further notice to any products herein. Freescale Semiconductor makes no warranty, representation or guarantee regarding the suitability of its products for any particular purpose, nor does Freescale Semiconductor assume any liability arising out of the application or use of any product or circuit, and specifically disclaims any and all liability, including without limitation consequential or incidental damages. “Typical” parameters that may be provided in Freescale Semiconductor data sheets and/or specifications can and do vary in different applications and actual performance may vary over time. All operating parameters, including “Typicals”, must be validated for each customer application by customer's technical experts. Freescale Semiconductor does not convey any license under its patent rights nor the rights of others. Freescale Semiconductor products are not designed, intended, or authorized for use as components in systems intended for surgical implant into the body, or other applications intended to support or sustain life, or for any other application in which the failure of the Freescale Semiconductor product could create a situation where personal injury or death may occur. Should Buyer purchase or use Freescale Semiconductor products for any such unintended or unauthorized application, Buyer shall indemnify and hold Freescale Semiconductor and its officers, employees, subsidiaries, affiliates, and distributors harmless against all claims, costs, damages, and expenses, and reasonable attorney fees arising out of, directly or indirectly, any claim of personal injury or death associated with such unintended or unauthorized use, even if such claim alleges that Freescale Semiconductor was negligent regarding the design or manufacture of the part.

## How to Contact Us

Corporate Headquarters	Freescale Semiconductor, Inc. 6501 William Cannon Drive West Austin, TX 78735 U.S.A.
World Wide Web	<a href="http://www.freescale.com/codewarrior">http://www.freescale.com/codewarrior</a>
Technical Support	<a href="http://www.freescale.com/support">http://www.freescale.com/support</a>

# Table of Contents

---

## I Introduction

<b>1</b>	<b>IDE User’s Guide Overview</b>	<b>17</b>
	Release Notes . . . . .	17
	Licensing. . . . .	17
	Documentation Structure . . . . .	18
	Documentation Formats . . . . .	18
	Documentation Types . . . . .	18
	Manual Conventions . . . . .	19
	Figure Conventions . . . . .	19
	Keyboard Conventions . . . . .	19
 <b>2</b>	 <b>CodeWarrior IDE Overview</b>	 <b>21</b>
	Development Cycle. . . . .	21
	CodeWarrior IDE Advantages . . . . .	23
	IDE Tools Overview . . . . .	24

## II Projects

<b>3</b>	<b>Working with Projects</b>	<b>29</b>
	About Projects. . . . .	29
	Project Manager . . . . .	29
	Build Targets . . . . .	31
	Managing Projects . . . . .	32
	Advanced Projects . . . . .	38
	Custom Project Stationery. . . . .	38
	Subprojects . . . . .	39
	Strategies . . . . .	40

## Table of Contents

---

<b>4</b>	<b>Project Window</b>	<b>43</b>
	About the Project Window . . . . .	43
	Project Window Pages . . . . .	45
	Files Page . . . . .	45
	Link Order Page . . . . .	49
	Targets Page . . . . .	49
	File, Group, Layout, and Target Management . . . . .	50
	Build-Target Management . . . . .	54
<b>5</b>	<b>Working with Files</b>	<b>59</b>
	Managing Files . . . . .	59
<b>6</b>	<b>Dockable Windows</b>	<b>65</b>
	About Dockable Windows . . . . .	65
	Working with Dockable Windows . . . . .	68
	Dock Bars . . . . .	72
<b>7</b>	<b>Workspaces</b>	<b>75</b>
	About Workspaces . . . . .	75
	Using Workspaces . . . . .	75
<b>8</b>	<b>Creating Console Applications</b>	<b>79</b>
	About Console Applications . . . . .	79
	Creating Console Applications . . . . .	79

## III Editor

<b>9</b>	<b>CodeWarrior Editor</b>	<b>85</b>
	Editor Window . . . . .	85
	Editor Toolbar . . . . .	88
	Interfaces Menu . . . . .	88
	Functions Menu . . . . .	88

---

Markers Menu . . . . .	88
Document Settings Menu . . . . .	89
Version Control System Menu . . . . .	89
Other Editor Window Components . . . . .	90
Path Caption . . . . .	90
File Modification Icon . . . . .	90
Breakpoints Column . . . . .	90
Text Editing Area . . . . .	90
Line and Column Indicator . . . . .	91
Pane Splitter and Resize Controls . . . . .	91
<b>10 Editing Source Code</b>	<b>93</b>
Text Manipulation . . . . .	93
Symbol Editing Shortcuts . . . . .	96
Punctuation Balancing . . . . .	96
Code Completion . . . . .	97
Code Completion Configuration . . . . .	98
Code Completion Window . . . . .	100
Commenting Code using the Keyboard . . . . .	106
<b>11 Navigating Source Code</b>	<b>107</b>
Finding Interface Files, Functions, Lines . . . . .	107
Finding Interface Files . . . . .	107
Locating Functions . . . . .	108
Going Back and Forward . . . . .	109
Using Markers . . . . .	110
Remove Markers Window . . . . .	110
Symbol Definitions . . . . .	112
<b>12 Finding and Replacing Text</b>	<b>115</b>
Single-File Find . . . . .	115
Single-File Find and Replace . . . . .	117
Multiple-File Find and Replace . . . . .	120
In Folders . . . . .	122
In Projects . . . . .	124

## Table of Contents

---

In Symbolics . . . . .	126
In Files . . . . .	128
Search Results Window . . . . .	130
Text-Selection Find . . . . .	132
Regular-Expression Find . . . . .	134
Using the Find String in the Replace String . . . . .	136
Remembering Sub-expressions . . . . .	137
Comparing Files and Folders . . . . .	137
Comparison Setup . . . . .	138
File Comparison . . . . .	141
Folder Comparison . . . . .	144

# IV Browser

## 13 Using the Browser 149

Browser Database . . . . .	149
Browser Data . . . . .	149
Browser Symbols . . . . .	152
Browser Contextual Menu . . . . .	152

## 14 Using Class Browser Windows 155

Class Browser window . . . . .	155
Classes Pane . . . . .	161
Member Functions Pane . . . . .	163
Data Members Pane . . . . .	164
Source Pane . . . . .	164
Status Area . . . . .	165

## 15 Using Other Browser Windows 167

Multiple-Class Hierarchy Window . . . . .	167
Single-Class Hierarchy Window . . . . .	170
Browser Contents window . . . . .	171
Symbols Window . . . . .	172

---

Symbols toolbar . . . . .	174
Symbols pane . . . . .	174
Source pane . . . . .	174
<b>16 Using Browser Wizards</b>	<b>175</b>
New Class Wizard . . . . .	175
The New Member Function Wizard . . . . .	179
The New Data Member Wizard . . . . .	181

## V Debugger

<b>17 Working with the Debugger</b>	<b>187</b>
About the Debugger . . . . .	187
About Symbolics Files . . . . .	188
Thread Window . . . . .	188
Common Debugging Actions . . . . .	192
Symbol Hint . . . . .	195
Contextual Menus . . . . .	196
Multi-Core Debugging . . . . .	197
Data Viewer Plug-ins . . . . .	198
External Builds Support . . . . .	198
External Build Wizard . . . . .	201
<b>18 Manipulating Program Execution</b>	<b>203</b>
Breakpoints . . . . .	203
Breakpoints Window . . . . .	204
Working with Breakpoints . . . . .	208
Working with Breakpoint Templates . . . . .	213
Eventpoints . . . . .	215
Log Point . . . . .	216
Pause Point . . . . .	218
Script Point . . . . .	218
Skip Point . . . . .	220

## Table of Contents

---

Sound Point (Windows OS) . . . . .	220
Trace Collection Off . . . . .	221
Trace Collection On . . . . .	222
Working with Eventpoints . . . . .	223
Watchpoints . . . . .	225
Special Breakpoints . . . . .	229
<b>19 Working with Variables</b>	<b>231</b>
Global Variables Window . . . . .	231
Variable Window . . . . .	233
Expressions Window . . . . .	235
<b>20 Working with Memory</b>	<b>239</b>
Memory Window . . . . .	239
Array Window . . . . .	243
Registers Window . . . . .	245
General Registers . . . . .	246
FPU Registers . . . . .	246
Host-specific Registers . . . . .	246
Register Details Window . . . . .	249
Description File . . . . .	252
Register Display . . . . .	252
Text View . . . . .	253
<b>21 Working with Debugger Data</b>	<b>255</b>
Symbolics Window . . . . .	255
System Browser Window . . . . .	258
Log Window . . . . .	260
<b>22 Profiler</b>	<b>263</b>
Overview . . . . .	263
What Is a Profiler? . . . . .	263
Types of Profilers . . . . .	264
A Profiling Strategy . . . . .	265
Profiling Source Code . . . . .	266

---



---

Using the Profiler . . . . .	266
What It Does . . . . .	266
How It Works . . . . .	267
Profiling Made Easy . . . . .	268
Configuring . . . . .	271
Profiler Libraries and Interface Files. . . . .	271
Profiling Special Cases . . . . .	272
Viewing Results . . . . .	278
What It Does . . . . .	278
How It Works . . . . .	278
Finding Performance Problems . . . . .	282
Troubleshooting . . . . .	283
Profile Times Vary Between Runs . . . . .	283
Problems while Profiling Inline Functions . . . . .	284
Profiling Library Could not be Found. . . . .	284
Reference . . . . .	285
Compiler Directives . . . . .	285
Memory Usage . . . . .	286
Time and Timebases . . . . .	287
Profiler Function Reference . . . . .	287
ProfilerInit(). . . . .	288
ProfilerTerm() . . . . .	289
ProfilerSetStatus(). . . . .	289
ProfilerGetStatus(). . . . .	290
ProfilerGetDataSizes() . . . . .	290
ProfilerDump() . . . . .	291
ProfilerClear() . . . . .	291
<b>23 Working with Hardware Tools</b>	<b>293</b>
Flash Programmer Window . . . . .	293
Target Configuration . . . . .	295
Flash Configuration. . . . .	297
Program / Verify . . . . .	299
Erase / Blank Check . . . . .	302
Checksum . . . . .	304

---

## Table of Contents

---

Hardware Diagnostics Window . . . . .	306
Configuration . . . . .	307
Memory Read / Write . . . . .	308
Scope Loop . . . . .	310
Memory Tests . . . . .	312
Trace Window . . . . .	317
Cache Window . . . . .	318
Profile Window . . . . .	319
Command Window . . . . .	320

# VI Compilers and Linkers

## 24 Compilers 325

Choosing a Compiler . . . . .	325
Compiling Projects . . . . .	325

## 25 Linkers 329

Choosing Linkers . . . . .	329
Linking Projects . . . . .	330

# VII Preferences and Target Settings

## 26 Customizing the IDE 333

Customizing IDE Commands . . . . .	333
Commands Tab . . . . .	335
Pre-Defined Variables in Command Definitions . . . . .	337
Customize Toolbars . . . . .	341
Kinds of Toolbars . . . . .	341
Toolbar Elements . . . . .	342
Modify a Toolbar . . . . .	342
Customize Key Bindings . . . . .	345

---

<b>27 Working with IDE Preferences</b>	<b>351</b>
IDE Preferences Window . . . . .	351
General Panels . . . . .	353
Build Settings . . . . .	353
Concurrent Compiles. . . . .	355
IDE Extras . . . . .	355
IDE Startup . . . . .	357
Help Preferences (Solaris and Linux) . . . . .	358
Plugin Settings. . . . .	359
Shielded Folders . . . . .	360
Source Trees . . . . .	362
Editor Panels . . . . .	365
Code Completion. . . . .	365
Code Formatting . . . . .	366
Editor Settings. . . . .	368
Font & Tabs. . . . .	370
Text Colors . . . . .	373
Debugger Panels . . . . .	376
Display Settings. . . . .	376
Window Settings . . . . .	378
Global Settings . . . . .	379
Remote Connections . . . . .	381
<b>28 Working with Target Settings</b>	<b>385</b>
Target Settings Window . . . . .	385
Target Panels . . . . .	387
Target Settings. . . . .	387
Access Paths . . . . .	389
Build Extras. . . . .	391
Runtime Settings . . . . .	393
File Mappings . . . . .	395
Source Trees . . . . .	397
Code Generation Panels . . . . .	397
Global Optimizations . . . . .	397

## Table of Contents

---

Editor Panels . . . . .	400
Custom Keywords . . . . .	401
Debugger Panels . . . . .	402
Other Executables . . . . .	402
Debugger Settings . . . . .	405
Remote Debugging . . . . .	406
<b>29 Preference and Target Settings Options</b>	<b>409</b>
A . . . . .	409
B . . . . .	411
C . . . . .	413
D . . . . .	416
E . . . . .	417
F . . . . .	421
G-I . . . . .	422
K-L . . . . .	425
M . . . . .	427
O . . . . .	428
P . . . . .	428
R . . . . .	430
S . . . . .	432
T . . . . .	440
U . . . . .	441
V . . . . .	445
W-Z . . . . .	446
<b>30 Register Details Window XML Specification</b>	<b>449</b>
Register Details Window XML Specification . . . . .	449
REGISTER . . . . .	451
BITFIELD . . . . .	453
BFVALUE . . . . .	456
Accessing the XML Files from CodeWarrior . . . . .	457
A Sample XML File . . . . .	458
Creating the New XML File . . . . .	458
Adding Multiple BITFIELD Attributes . . . . .	459

---

---

Adding BFVALUE Attributes . . . . .	461
Completing the New XML File . . . . .	463
References . . . . .	466

## VIII Menus

### 31 IDE Menus 469

File Menu . . . . .	469
Edit Menu . . . . .	470
View Menu . . . . .	472
Search Menu . . . . .	473
Project Menu . . . . .	474
Debug Menu . . . . .	476
Data Menu . . . . .	479
VCS Menu . . . . .	480
Window Menu . . . . .	481
Help Menu . . . . .	481

### 32 Menu Commands 483

A . . . . .	483
B . . . . .	485
C . . . . .	486
D . . . . .	491
E . . . . .	492
F . . . . .	494
G . . . . .	496
H . . . . .	497
I . . . . .	498
K-L . . . . .	498
M-N . . . . .	499
O . . . . .	501
P-Q . . . . .	501
R . . . . .	503



## Table of Contents

---

S.....	507
T-U.....	511
V-Z.....	515

<b>Index</b>	<b>519</b>
--------------	------------

# Introduction

---

This section consists of these chapters:

- [IDE User's Guide Overview](#)
- [CodeWarrior IDE Overview](#)





# IDE User's Guide Overview

---

This chapter of the *CodeWarrior™ Development Studio IDE 5.9 User's Guide* is a high-level description of documentation and training resources for learning to use the IDE.

- [Documentation Structure](#)—a guide to the various CodeWarrior manuals available. This guide notes the location of generic and specific product documentation.
- [Manual Conventions](#)—some common typographical conventions used in this manual and other CodeWarrior documentation.

## Release Notes

Please read the release notes, which contain important last-minute additions to the documentation. The Release Notes folder is located on the CodeWarrior CD.

## Licensing

Web-based licensing is available. It is a server licensing solution that generates FlexLM v8 or later based license keys automatically over the world wide web through a registration/activation process. You can register and activate permanent, node-locked license keys.

CodeWarrior products are shipped to customers with registration cards that contain a unique registration number. Products that ship with a one year annual support certificate will also have a unique registration number.

During product installation you will be instructed to register at:

<http://www.freescale.com/cwregister>

---

**NOTE** You can also reach the registration website by selecting the **Help > CodeWarrior Website** menu command from the IDE's main menu.

---

Once you are at the website, select **Licensing and Registration > Registration and Activation** from the menu at the left of the page. Continue using the online instructions to register and activate your product.

An email will be sent to you with the License Authorization Code and instructions. The resulting license keys are automatically updated into the license.dat text file of the CodeWarrior product executing the authorization. You can also manually edit the

license.dat file per instructions provided in the `License_Install.txt` file in the root folder of your CodeWarrior installation path. If the IDE evaluation period expires prior to activation, you will have to manually edit the license.dat file.

## Documentation Structure

CodeWarrior products include an extensive documentation library of user guides, targeting manuals, and reference manuals. Take advantage of this library to learn how to efficiently develop software using the CodeWarrior programming environment.

## Documentation Formats

CodeWarrior documentation presents information in various formats:

- **Print**—Printed versions of CodeWarrior manuals, including the *IDE User's Guide*, *MSL C Reference*, *C/C++ Reference*, and product-focused Targeting manuals.
- **PDF** (Portable Document Format)—Electronic versions of CodeWarrior manuals. The CodeWarrior CD Documentation folder contains the electronic PDF manuals.
- **HTML** (Hypertext Markup Language)—HTML or Compressed HTML (.CHM) versions of CodeWarrior manuals. Also select **Help > CodeWarrior Help** in the IDE Development Studio.

## Documentation Types

Each CodeWarrior manual focuses on a particular information type:

- **User guides**—User guides provide basic information about the CodeWarrior user interface. User guides include information that supports all host platforms on which the software operates, but do not include in-depth platform-specific information.
- **Targeting manuals**—Targeting manuals provide specific information required to create software that operates on a particular platform or microprocessor. Examples include the *Targeting Windows*, *Targeting Java*, and *Targeting DSP56800* manuals.
- **Reference manuals**—Reference manuals provide specialized information that supports coding libraries, programming languages, and the IDE. Examples include the *C Compiler Reference*, *MSL C Reference*, and *Extending the CodeWarrior IDE* manuals.
- **Core manuals**—Core manuals explain the core technologies available in the CodeWarrior IDE. Examples include:
  - *IDE User's Guide*
  - *C/C++ Compilers Reference*

- *MSL C Reference and MSL C++ Reference*
- *Extending the CodeWarrior IDE*
- *Command-Line Tools Reference*

## Manual Conventions

This section explains conventions in the *IDE User's Guide*.

### Figure Conventions

The CodeWarrior IDE employs a virtually identical user interface across multiple hosts. For this reason, illustrations of common interface elements use images from any host. However, some interface elements are unique to a particular host. In such cases, clearly labelled images identify the specific host.

### Keyboard Conventions

The CodeWarrior IDE accepts keyboard shortcuts, or *key bindings*, for frequently used operations. For each operation, this manual lists corresponding key bindings by platform. Hyphens separate multiple keystrokes in each key binding.



**IDE User's Guide Overview**  
*Manual Conventions*

---

# CodeWarrior IDE Overview

---

The CodeWarrior™ Integrated Development Environment (IDE) provides an efficient and flexible software-development tool suite. This chapter explains the advantages of using the CodeWarrior IDE and provides brief descriptions of the major tools that make up the IDE.

This chapter consists of these sections:

- [Development Cycle](#)
- [CodeWarrior IDE Advantages](#)
- [IDE Tools Overview](#)

## Development Cycle

A software developer follows a general development process:

1. Begin with an idea for new software
2. Implement new idea in source code
3. Have the IDE compile source code into machine code
4. Have the IDE link machine code and form an executable file
5. Correct errors (debug)
6. Compile, link, and release a final executable file.

The stages of the development cycle correspond to one or more chapters in this manual.

[Figure 2.1](#) depicts the development cycle as a flowchart. [Table 2.1](#) details the different stages and their corresponding sections in this manual.

# CodeWarrior IDE Overview

## Development Cycle

Figure 2.1 Development Cycle Diagram

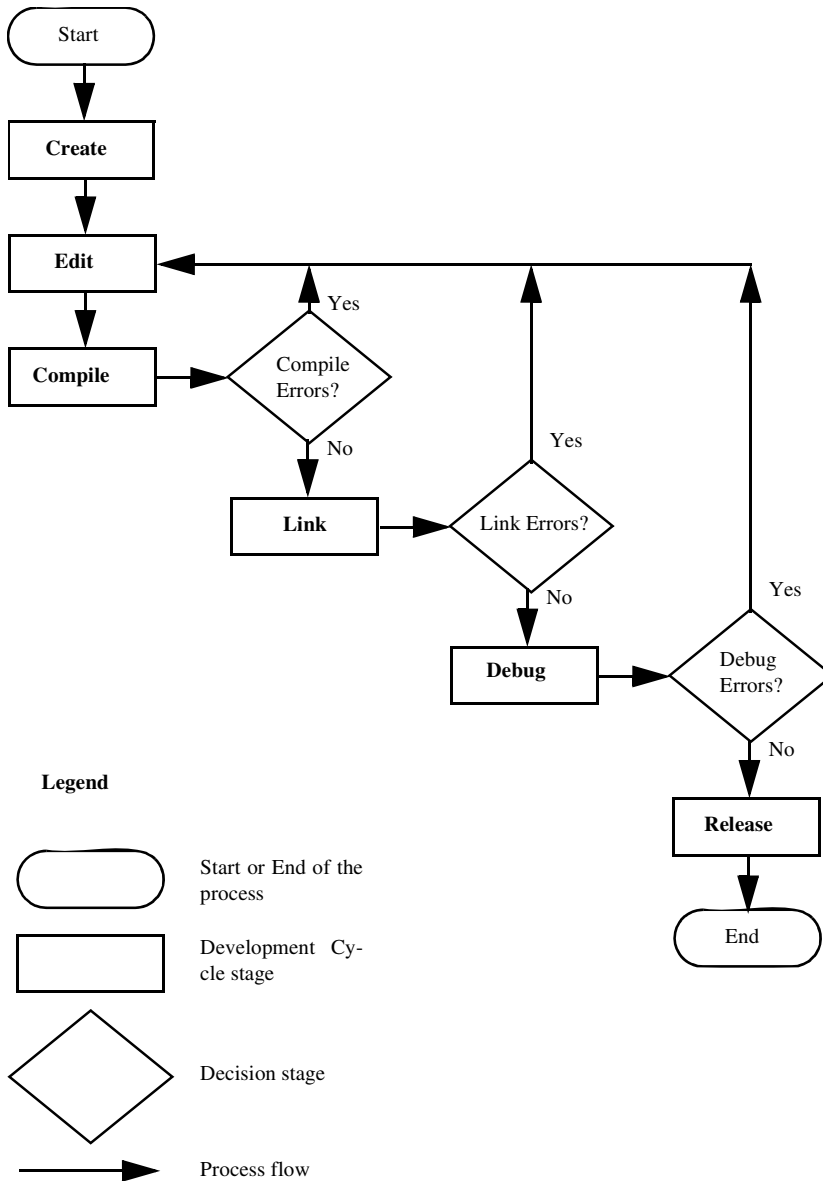

**Table 2.1 Stage Descriptions, Related User's Guide Sections**

Stage	Description	Related Sections
<b>Create</b>	Create the initial project, source files, and build targets.	<ul style="list-style-type: none"> <li>• <a href="#">Projects</a></li> <li>• <a href="#">Preferences and Target Settings</a></li> <li>• <a href="#">Menus</a></li> </ul>
<b>Edit</b>	Transform your project into working source code, organize interface elements, and correct errors.	<ul style="list-style-type: none"> <li>• <a href="#">Editor</a></li> <li>• <a href="#">Browser</a></li> </ul>
<b>Compile</b>	Compile the source code into machine format that operates on the target host.	<a href="#">Compilers and Linkers</a>
<b>Link</b>	Link the separate compiled modules into a single binary executable file.	<a href="#">Compilers and Linkers</a>
<b>Debug</b>	Find and resolve all coding and logic errors that prevent the program from operating as designed.	<a href="#">Debugger</a>
<b>Release</b>	Release for public use.	Beyond the scope of this manual.

## CodeWarrior IDE Advantages

- **Cross-platform development**  
Develop software to run on multiple operating systems, or use multiple hosts to develop the same software project. The IDE runs on popular operating systems, including Windows, Solaris, and Linux. The IDE uses virtually the same graphical user interface (GUI) across all hosts.
- **Multiple-language support**  
Choose from multiple programming languages when developing software. The IDE supports high-level languages, such as C, C++, and Java, as well as in-line assemblers for most processors.

## CodeWarrior IDE Overview

### IDE Tools Overview

---

- Consistent development environment  
Port software to new processors without having to learn new tools or lose an existing code base. The IDE supports many common desktop and embedded processor families, including x86, PowerPC, MIPS, and many others.
- Plug-in tool support  
Extend the capabilities of the IDE by adding a plug-in tool that supports new services. The IDE currently supports plug-ins for compilers, linkers, pre-linkers, post-linkers, preference panels, version controls, and other tools. Plug-ins make it possible for the CodeWarrior IDE to process different languages and support different processor families.

## IDE Tools Overview

The CodeWarrior IDE is a tool suite that provides sophisticated tools for software development. This section explains the standard tools available in the IDE:

- a project manager
- an editor
- a search engine
- a source browser
- a build system
- a debugger

[Table 2.2](#) explains the purpose of these tools and lists corresponding CodeWarrior IDE features.



**Table 2.2 IDE Tools and Features**

<b>Tool</b>	<b>Purpose</b>	<b>CodeWarrior IDE Features</b>
<b>Project Manager</b>	Manipulate items associated with a project	<ul style="list-style-type: none"> <li>• Handles top-level file management for the software developer</li> <li>• Organizes project items by major group, such as files and targets</li> <li>• Tracks state information (such as file-modification dates)</li> <li>• Determines build order and files to be included in each build</li> <li>• Coordinates with plug-ins to provide version-control services</li> </ul>
<b>Editor</b>	Create and modify source code	<ul style="list-style-type: none"> <li>• Uses color to differentiate programming-language keywords</li> <li>• Allows definition of custom keywords for additional color schemes</li> <li>• Automatically verifies parenthesis, brace, and bracket balance</li> <li>• Allows use of menus for navigation to any function or into the header files used by the program</li> </ul>
<b>Search Engine</b>	Find and replace text	<ul style="list-style-type: none"> <li>• Finds a specific text string</li> <li>• Replaces found text with substitute text</li> <li>• Allows use of regular expressions</li> <li>• Provides file-comparison and differencing functionality</li> </ul>
<b>Source Browser</b>	Manage and view program symbols	<ul style="list-style-type: none"> <li>• Maintains a symbolics database for the program. Sample symbols include names and values of variables and functions.</li> <li>• Uses the symbolics database to assist code navigation</li> <li>• Links every symbol to other locations in the code related to that symbol</li> <li>• Processes both object-oriented and procedural languages</li> </ul>

## CodeWarrior IDE Overview

### IDE Tools Overview

**Table 2.2 IDE Tools and Features (continued)**

Tool	Purpose	CodeWarrior IDE Features
<b>Build System</b>	Convert source code into an executable file	<ul style="list-style-type: none"> <li>• Uses compiler to generate object code from source code</li> <li>• Uses linker to generate final executable file from object code</li> </ul>
<b>Debugger</b>	Resolve errors	<ul style="list-style-type: none"> <li>• Uses symbolics database to provide source-level debugging</li> <li>• Supports symbol formats such as CodeView, DWARF (Debug With Arbitrary Records Format), and SYM (SYMBOLic information format)</li> </ul>



# Projects

---

This section consists of these chapters:

- [Working with Projects](#)
- [Project Window](#)
- [Working with Files](#)
- [Dockable Windows](#)
- [Workspaces](#)
- [Creating Console Applications](#)



# Working with Projects

---

This chapter explains how to work with projects in the CodeWarrior™ IDE. Projects organize several file types associated with a computer program:

- Text files—files that contain any kind of text. Sample text files include Read Me files and source files.
- Source files—files that contain source code only. Sample source files include C++ files and Java files.
- Library files—files that contain special code designed to work together with a particular programming language or operating environment.
- Generated files—files created by the IDE while building or debugging the project.

This chapter consists of these sections:

- [About Projects](#)
- [Managing Projects](#)
- [Advanced Projects](#)

## About Projects

The IDE uses build targets and a Project Manager to organize source code and support files. This section explains both components.

### Project Manager

The IDE gathers source, library, resource, and other files into a *project*. The Project Manager manipulates the information stored in the project.

[Figure 3.1](#) diagrams Project Manager interactions with IDE tools. [Table 3.1](#) explains the interactions.

## Working with Projects

### About Projects

**Figure 3.1 Project Manager**

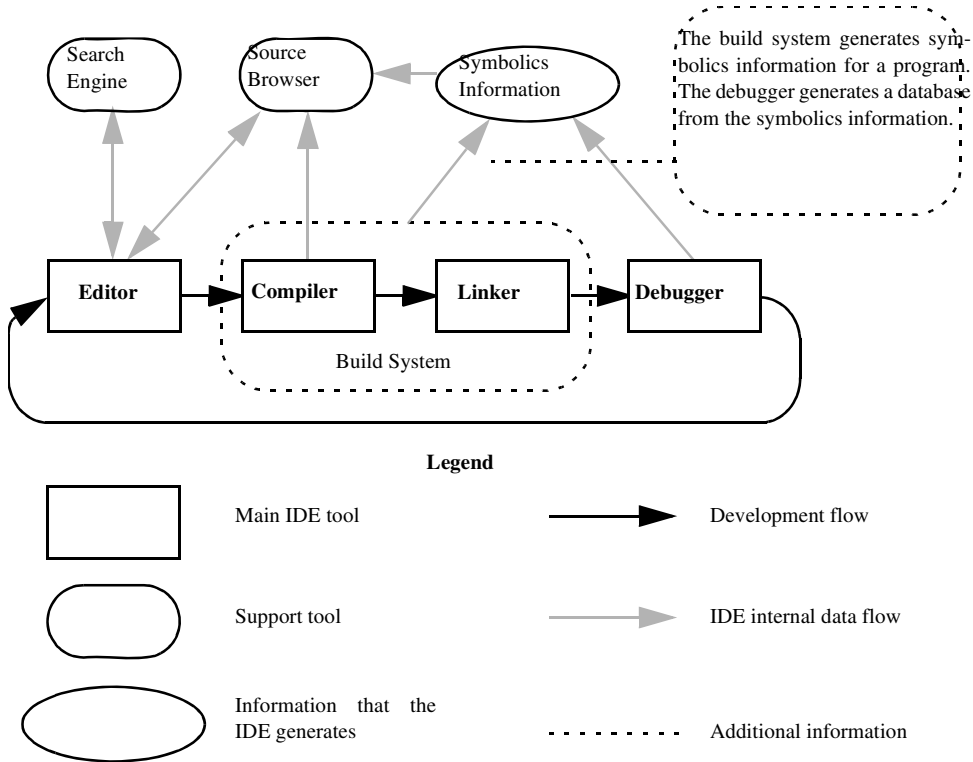

**Table 3.1 Project Manager Interactions**

IDE Tool	Project Manager Interactions
Editor	<ul style="list-style-type: none"> <li>Coordinates internal data flow among editor windows, search engine, and source browser</li> <li>Matches find-and-replace results between related header files and source files</li> <li>Associates functions and variables with corresponding source code</li> </ul>
Compiler	<ul style="list-style-type: none"> <li>Synchronizes a symbolics database of program functions, variables, and values with source code</li> <li>Coordinates internal data flow between symbolics database and source browser</li> <li>Determines files to include in build process</li> </ul>

**Table 3.1 Project Manager Interactions (*continued*)**

IDE Tool	Project Manager Interactions
Linker	<ul style="list-style-type: none"> <li>• Sends compiled object code to linker for conversion to executable code</li> <li>• Sets the link order for processing compiled object code</li> </ul>
Debugger	<ul style="list-style-type: none"> <li>• Matches debugging data to source code</li> <li>• Updates symbolics database to reflect changing values during a debug session</li> </ul>

## Build Targets

For any given build, the project manager tracks:

- files and libraries
- link order
- dependencies
- compiler, linker, and other settings

The IDE stores this information in a *build target*. As the project changes, the project manager automatically updates the build target. The project manager also coordinates program builds, using the build-target information to call the appropriate tools in the correct order with the specified settings.

For example, the project manager directs the build system to compile only those source files that rely on information in a modified file.

Note that all of this operation happens automatically. The software developer does not need to remember makefile syntax or semantics, and never has to debug makefile syntax errors. The IDE simplifies the process, making it easier to develop software.

The project manager also supports multiple build targets within the same project file. Each build target can have its own unique settings, and even use different source and library files. For example, it is common to have both debug and release build targets in a project.

[Figure 3.2](#) shows a sample project with debug and release build targets.

**Figure 3.2 Project with Multiple Build Targets**

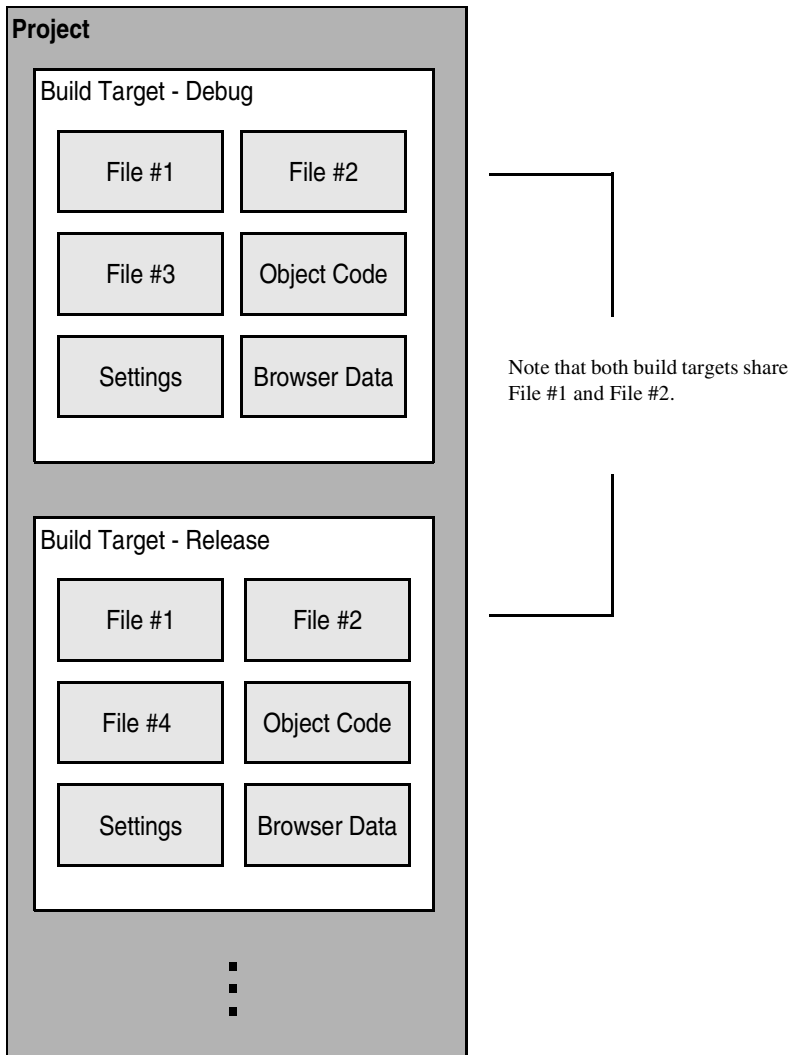

## Managing Projects

Use these tasks to manage projects:

- Create a new project



- Open existing project
- Save project
- Close project
- Inspect an open project
- Print an open project

---

## Creating New Projects using Project Stationery

Use the project stationery provided with the IDE to quickly create new projects. The stationery contains everything needed for a minimal, ready-to-run project. Use project stationery as a foundation upon which to add features for each new project.

1. Select **File > New**.
2. Click the **Project** tab and select a project type.
3. Enter a project name (include the `.mcp` extension) in the **Project Name** field and set the **Location** for the new project.
4. Click **OK** in the **New** window.
5. Select the appropriate project stationery from the **New Project** window.
6. Click **OK** in the **New Project** window.

The IDE uses the selected stationery as a template to create a new project.

---

## Creating New Projects from Makefiles

Use the Makefile Importer wizard to convert most Visual C `nmake` or GNU `make` files into projects. The wizard performs these tasks:

- Parses the makefile to determine source files and build targets
  - Creates a project
  - Adds the source files and build targets determined during parsing
  - Matches makefile information, such as output name, output directory, and access paths, with the newly created build targets.
  - Selects a project linker
1. Select **File > New**.
  2. Click the **Project** tab.
  3. Select **Makefile Importer Wizard**.

## Working with Projects

### Managing Projects

---

4. Enter a project name (include the `.mcp` extension) in the **Project Name** field and set the **Location** for the new project.
5. Click **OK** in the **New** window.
6. Enter the path to the makefile in the **Makefile location** field or click **Browse** to navigate to the makefile.
7. Choose the tool set used for makefile conversion and linker selection.
  - **Tool Set Used In Makefile**—Choose the tool set whose build rules form the basis of the makefile.
  - **CodeWarrior Tool Set**—Choose the linker tool set to use with the generated project.
8. Select the desired diagnostic settings.
  - **Log Targets Bypassed**—Select to log information about makefile build targets that the IDE fails to convert to project build targets.
  - **Log Build Rules Discarded**—Select to log information about makefile rules that the IDE discards during conversion.
  - **Log All Statements Bypassed**—Select to log targets bypassed, build rules discarded, and other makefile items that the IDE fails to convert.
9. Click **Finish**, then **Generate**.

The Makefile Importer wizard performs the conversion process and displays additional information.

---

## Creating Empty Projects

Unlike project stationery, empty projects do not contain a pre-configured collection of template source files, library files, or build targets. Empty projects allow advanced software engineers to custom-build new projects from scratch.

---

**NOTE** Avoid creating empty projects. Instead, modify a project created with project stationery. Project stationery pre-configures complicated settings to quickly get started.

---

1. Select **File > New**.
2. Click the **Project** tab and select **Empty Project**.
3. Enter a project name (include the `.mcp` extension) in the **Project Name** field and set the **Location** for the new project.
4. Click **OK** in the **New** window.

The IDE creates an empty project. Add files and libraries, create build targets, and choose the appropriate target settings to complete the new project.

---

## Opening Projects

Use the IDE to open previously saved projects. CodeWarrior projects normally end in the extension of `.mcp`. Open projects to add, remove, or modify files to enhance the capabilities of the final executable file.

1. Select **File > Open**.
2. Find and select the project to open.
3. Click **Open**.

The IDE opens the project and displays its Project window.

---

**NOTE** The IDE prompts you for confirmation to update projects created in older CodeWarrior versions.

---

## Opening Projects Created on Other Hosts

CodeWarrior projects whose names end in `.mcp` are cross-platform. However, the object code stored inside each project folder is not cross-platform. Use these procedures to properly open the project on a different host computer.

1. If not present, add the `.mcp` filename extension to the project name.
  2. Copy the project folder from the original host to the new host.
  3. Delete the `Data` folder inside the newly copied project folder.
  4. Open the newly copied project on the new host IDE.
  5. Recompile the project to generate new object code.
- 

## Saving Projects

The IDE automatically saves projects and updates project information after performing these actions:

- Closing the project
  - Applying or saving a preference or target-setting option
  - Adding, deleting, or compiling a file
  - Editing group information
-

## Working with Projects

### Managing Projects

---

- Removing or compacting object code
  - Quitting the IDE
- 

## Inspecting Project Files

Use the **Project Inspector** command to review and configure source-file attributes and target information in the Project Inspector window.

1. Select a file in the Project window.
2. Open the **Project Inspector** window, as explained in [Table 3.2](#).

**Table 3.2** Opening the Project Inspector Window

On this host...	Do this...
Windows	Select <b>View &gt; Project Inspector</b> .
Solaris	Select <b>Window &gt; Project Inspector</b> .
Linux	Select <b>Window &gt; Project Inspector</b> .

3. Examine the source-file attributes and target settings.
    - Click the **Attributes** tab to view the file attributes.
    - Click the **Targets** tab to view the build targets that use the file.
- 

## Printing Projects

The Project Manager can print a complete listing of the **Files**, **Designs**, **Link Order**, or **Targets** tab currently displayed in the Project window.

1. Select the Project window.
2. Click the **Files**, **Designs**, **Link Order**, or **Targets** tab.
3. Select **File > Print**.
4. Set the print options in the print dialog.
5. Print the Project window contents.

The IDE prints the contents of the selected tab.

## Choosing a Default Project

The IDE allows multiple open projects at the same time. However, a given source file can belong to more than one open project, making it ambiguous as to which project a source-file operation applies.

To resolve ambiguity, choose the default project to which the IDE applies operations.

1. If only one project is open, it automatically becomes the default project.
2. If more than one project is open, select **Project > Set Default Project** to select the desired default project.

In ambiguous situations, the IDE applies operations to the selected default project.

---

## Exporting Projects to XML Files

The IDE can export a project to an Extensible Markup Language (XML) file. Use this capability to store projects in text-oriented environments, such as a version control system.

1. Bring the project to export forward (in focus).
2. Select **File > Export Project**.
3. Name the exported XML file and save it in the desired location.

The IDE converts the project to an XML file.

---

## Importing Projects Saved as XML Files

The IDE can import a project previously saved in Extensible Markup Language (XML) format. Use this capability to recreate projects stored in text-oriented environments, such as a version control system.

1. Select **File > Import Project**.
2. Create a new folder in which to save the converted project and all of its generated files.
3. Find the XML file that you want to import.
4. Save the XML file in the newly created folder.

The IDE converts the XML file to a project.

---

### Closing Projects

Use the **Close** command to close a CodeWarrior project file at the end of a programming session. The IDE automatically saves changes to a closed project.

1. Select the Project window to close.
2. Close the project.
  - Select **File > Close**.
  - Click the close box in the Project window.

## Advanced Projects

Advanced projects deal with these topics:

- Custom project stationery—modified project stationery tailored to advanced programming needs.
- Subprojects—projects within projects.
- Strategies—obtaining the maximum benefit from advanced projects.

### Custom Project Stationery

Use custom project stationery to develop streamlined templates to meet advanced programming needs.

- Pre-configure new project stationery to include often-used files, libraries, and source code
- Configure build targets and options to any desired state
- Set up a reusable template to use for creating projects

---

**NOTE** Custom project stationery requires in-depth knowledge about project structure and operation. Before creating custom stationery, be sure to fully understand existing project stationery included with the CodeWarrior product.

---

### Creating Custom Project Stationery

Use custom project stationery to develop a convenient template for creating new projects. An efficient way to develop custom stationery is to modify existing project stationery and save it under a new name in the **Stationery** or **Project Stationery** folder.

1. Follow the usual process for creating a project from project stationery.  
See [Creating New Projects using Project Stationery](#) for more information.
2. Select **File > Save A Copy As**.
3. Find the **Project Stationery** folder in the CodeWarrior installation.
4. Create a folder inside the **Project Stationery** folder to store the newly created project.
5. **Save** the project to its new folder. Use a descriptive project name with the `.mcp` extension.
6. Customize the newly saved project so that it becomes a template for creating other projects:
  - Add source files to the project. Save these files in the same folder as the project itself.
  - Add build targets for building the project with frequently used settings.
  - Configure other project preferences as desired.
7. Close the customized project to save it.
8. Open the customized project folder inside the **Project Stationery** folder.
9. Find and delete the `_Data` folder.

The IDE now treats the customized project as project stationery. The descriptive name appears in the **Project** tab of the **New** window.

## Subprojects

A subproject is a project nested inside a parent project. Subprojects organize source code for the IDE to build prior to building the parent project. For example, the IDE builds subprojects for an application's plug-ins before building the parent project for the application itself.

---

**NOTE** Subprojects will build in order from top to bottom as listed in the GUI and from deeper to shallower in the dependency nesting.

---

---

## Adding Subprojects to a Project

Use a subproject to organize a separate set of source files and build targets inside a parent project.

1. Open the parent project in which to add a subproject.
2. Click the **Files** tab in the Project window.

## Working with Projects

### Advanced Projects

---

3. If the parent project has more than one build target, use the build-target list box in the Project window toolbar to choose the desired build target.
4. Add a separate project to the Project window:
  - Drag and drop the `.mcp` file of the separate project into the Project window, or
  - Select **Project > Add Files** to add the `.mcp` file of the separate project.

The IDE treats the added project as a subproject. The subproject appears in the **Files** view of the parent Project window.

5. If you want to build subprojects before the parent project is built, make the subtargets active:
  - a. Click the **Targets** tab in the Project window.
  - b. Expand a target to reveal the subprojects.
  - c. Expand a subproject to reveal its subtargets
  - d. Click a subtarget's icon to make the subtarget active. The “target” icon changes to an “arrowed target” icon.

---

## Opening Subprojects

The IDE can open a subproject from the parent Project window. Use this feature to more conveniently open the subproject.

1. Double-click the subproject in the **Files** view of the parent Project window.
2. The IDE opens the subproject in its own Project window.

## Strategies

Projects can organize files into build targets or subprojects. Each of these structures has its own advantages. Choose the structure best suited to the programming need.

## Build Targets

Build targets organize collections of files inside a project. Build targets have these advantages:

- Using multiple build targets inside a single project allows access to all source code for that project.
- Build targets organize different collections of build settings for a single project.
- Each project accommodates up to 255 build targets.



## Subprojects

Subprojects incorporate separate, standalone projects into parent projects. Subprojects have these advantages:

- Subprojects separate distinct parts of a complex program, such as an application and its various plug-ins.
- Using subprojects streamlines a complicated build. For example, create a project that builds all plug-ins for an application. Add this project as a subproject of the main application. The IDE then builds all plug-ins before building the main application.
- Use subprojects to break down a complicated project that approaches the 255 build-target limit. Organize related build targets into different subprojects to improve build speed.



## **Working with Projects**

*Advanced Projects*

---

# Project Window

---

This chapter explains how to work with the Project window in the CodeWarrior™ IDE. The Project window provides these features:

- view and modify all files created for use with a computer program.
- manipulate files arranged by type.
- control the way the IDE handles files.

This chapter consists of these sections:

- [About the Project Window](#)
- [Project Window Pages](#)
- [File, Group, Layout, and Target Management](#)
- [Build-Target Management](#)

## About the Project Window

The Project window organizes files in a computer program. Use this window to control various aspects of each file. The window includes these items:

- Project window toolbar
- Tabs
- Columns

[Figure 4.1](#) shows a sample Project window. [Table 4.1](#) explains the items in the Project window.

---

**NOTE** The number and names of the tabs in the Project window depend on the current build target and on the installed IDE plug-ins.

---

## Project Window

About the Project Window

Figure 4.1 Project Window

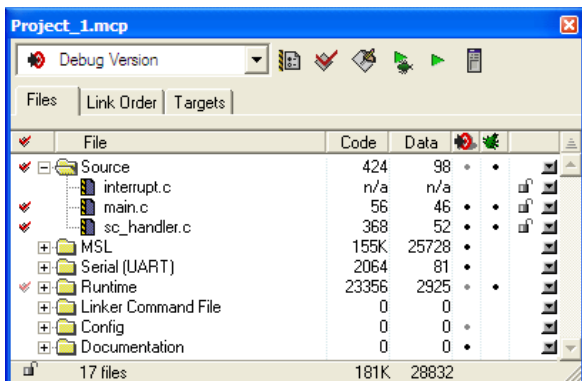



Table 4.1 Project Window Items

Item	Icon	Explanation
Current Target		Use to specify the build target that you want to modify.
Target Settings		Click to view and edit the settings for the current build target. You can also display settings for a target selected in Targets tab.
Synchronize Modification Dates		Click to check the modification dates of each project file and mark those files that need compilation.
Make		Click to compile and link all modified and manually selected (touched) project files.
Debug		Click to debug the current build target.
Run		Click to compile and link the current build target, then run the program.

**Table 4.1 Project Window Items (continued)**

Item	Icon	Explanation
Project Inspector		Click to view project information and edit file-specific information.
Files		Click to display the Files page. This page shows a list of files in the project and their associated properties.
Link Order		Click to display the Link Order page. This page shows the link order of files in the current build target.
Targets		Click to display the Targets page. This page shows a list of all build targets, sub-projects, and target-linking information.

## Project Window Pages

The Project window uses pages to organize items:

- Files
- Link Order
- Targets

---

**NOTE** For some targets, Project window contain Overlays tab instead of the Link Order tab. For information about the Overlays tab, see the *CodeWarrior Build Tools Reference*.

---

### Files Page

The Files page shows information about individual files in a project. The Files page shows information about these file types:







- Text files—files that contain any type of text. Sample text files include Read Me files and source files.
- Source files—files that contain source code only. Sample source files include C++ files and Java files.
- Library files—files that contain special code designed to work together with a particular programming language or operating environment.

## Project Window

### Project Window Pages

[Table 4.2](#) explains the items in the Files page.

**Table 4.2 Files Page Items**

Item	Icon	Explanation
Touch		Indicates the touch status of each file. Click in this column to toggle touching a file. Touching a file manually selects it for compilation during the next build. Click the Touch icon to sort files by touch status.
File		Displays a hierarchical view of the file and group names used by the project. Click the column title to sort files by name. Double-click a file to open it. Use the hierarchical controls to display and hide group contents.
Code		Displays the size, in bytes or kilobytes, of the compiled executable object code for files and groups. Click the column title to sort files by code size.
Data		Displays the size, in bytes or kilobytes, of non-executable data in the object code for files in the project. Click the column title to sort files by data size.
Target		Indicates whether each file belongs to the current build target. Click in this column to toggle inclusion status. A black dot indicates that a file is included with current build target. Click the Target icon to sort files by inclusion status. The Target column appears only when the project has more than one build target.
Debug		Displays debugging status. Click in this column to toggle generation of debugging information for a file or group. Click the Debug icon to sort files by debugging status.
Checkout Status		Displays icons representing the current file status in a version-control system. The Checkout Status column appears only when the project uses a version-control system to manage files.
Interfaces		Click to display a list of files inside a group or a list of <code>#include</code> files inside a source file. Choose a file to open it.
Sort Order		Click to toggle sorting between ascending and descending order for the active column. The icon indicates the current sort order.

## Viewing a File Path

To distinguish between two files that have identical names but reside in different folders, examine the file path.

To view the complete path of a file, perform the task explained in [Table 4.3](#).

**Table 4.3 Viewing a File Path**

On this host...	Do this...
Windows	Right-click the filename and select <b>Open in Windows Explorer</b>
Solaris	Click and hold on the filename, then select <b>File Path</b> .
Linux	Click and hold on the filename, then select <b>File Path</b> .

The File Path submenu shows the path to the file.

## File Management

The Project window lists all files found for all targets. If access paths are different for each target and a file with the same name exists in each path, the Project window will list the occurrence of each file.

For example, if two header files named `example.h` are used with two targets (TargetA and TargetB) and exist in separate locations for each target, you will see two entries of `example.h` in the Project window. If both targets use the same file in one location, then a single entry will appear in the Project window.

Select a file in the Files tab of the Project window and view the Project Inspector window to reveal the path for the selected file, and which targets use the file. You can also right-click a file to display a context menu and select Open in Windows Explorer (Windows) or File Path (Linux/Solaris) to display the path.

If a black dot is present in the Target column for a listed file, then it is in the current target. You can select this dot to toggle whether or not to include this file with the current target. Double-click a source file to open it in the editor.

If you enable the **Save project entries using relative paths** option in the Target Settings panel, file locations will be stored using a relative path from the access paths defined in the Access Paths panel. If disabled, the IDE remembers project entries only by name. This can cause unexpected results if two or more files share the same name. In this case, re-searching for files by selecting the Project > Re-search for Files menu command could cause the IDE to find the file in a different access path.

**NOTE** If you use source files with the same name in different locations, you should enable the **Save project entries using relative paths** option.

Duplicate file names can also appear in the Files tab of the Project window if a file is not found on one of the access paths. This can happen if an access path has been removed from the User Paths group in the Access Paths target settings panel. When the access path is removed, a duplicate appears in the Project window. The duplicate entry remains displayed until the access path is restored.

If a project with several targets (for example Debug and Release target) uses the same file, that file is shown as a single entry. If you remove the access path for that file, then a duplicate entry will appear in the file list. This duplicate represents a missing file for the current target. The second file entry is still available for the other target. Restore the access path and select **Project > Re-search for Files** to remove the duplicate entry in the list.

The **Project > Re-search for Files** command speeds up builds and other project operations. The IDE caches the location of project files after finding them in the access paths. **Re-search for Files** forces the IDE to forget the cached locations and re-search for them in the access paths. This command is useful if you moved several files and you want the IDE to find the files in their new locations.

If the **Save project entries using relative paths** option is enabled, the IDE does not reset the relative-path information stored with each project entry, so re-searching for files looks for source files in the same location. If the files are not there, the IDE only re-searches for header files. To force the IDE to also re-search for source files, select the **Project > Reset Project Entry Paths** menu command. If the **Save project entries using relative paths** option is disabled, the IDE re-searches for both header files and source files.

The **Reset Project Entry Paths** command resets the location information stored with each project entry and forces the IDE to re-search for project entries in the access paths. This command does nothing if the **Save project entries using relative paths** option is disabled.

**NOTE** If the IDE is unable to locate or resolve the location of project files, a Rescued items folder will appear. The IDE tries to locate the missing files and creates new references. This can happen when project data information, access paths, or other location settings in target settings panels are missing or have been compromised, for example, if the location of a project and related data directory have changed. One way this can happen is if a project has been committed to a source repository by one person and checked out to a different location by another person and a new project data folder is created.



---

## Link Order Page

The Link Order page shows information about the order in which the IDE links project files. Manipulate the files in this page to change the link order. For example, if file B depends on file A in order to function, move file B below file A in the Link Order page.

[Table 4.4](#) explains the items in the Link Order page.

**Table 4.4 Link Order Page Items**

Item	Explanation
Synchronize Modification Dates	To update the modification dates of files stored in a project, click the checkmark icon.  Use the Synchronize Modification Dates command to update files modified outside of the CodeWarrior IDE, perhaps by a third-party editor that cannot notify the CodeWarrior IDE of changes.
Synchronize Status	To update version-control status information, click the Pencil icon.

## Targets Page

The Targets page presents information about the build targets in a project. Use this page to create, manage, or remove build targets. Different build targets can store different IDE settings. For example, two build targets can handle the same project. One build target handles debugging the software, while the other build target handles building the software for final release.



[Table 4.5](#) explains items in the Targets page.

## Project Window

*File, Group, Layout, and Target Management*

---

**Table 4.5 Targets Page Items**

Item	Explanation
Targets	<p>Displays all build targets and subprojects that the IDE processes to create a binary file. These icons denote build-target status:</p> <ul style="list-style-type: none"> <li>  active build target         </li> <li>  inactive build target         </li> </ul>
Link	<p>Indicates the dependencies between build targets and subprojects. Link column is the far right column of the Targets page.</p>

## File, Group, Layout, and Target Management

Use these tasks to manage files, groups, layouts, and targets:

- Create an item.
- Delete an item.
- Move an item.
- Rename an item.
- Touch an item.
- Manage items.
- Set default items.
- Configure item settings.

---

### Removing Files/Groups/Layouts/Targets

The **Remove** command deletes files, groups, layouts, and build targets from the Project window. Removing files from the **Files** tab removes them from the project itself and from all build targets that use the files. Removing a file from the **Link Order**, **Segments**, or **Overlays** tab only removes the file from the current build target.

## Removing files/groups/layouts/targets from a project

1. Click the **Files**, **Designs**, or **Targets** tab in the Project window.
2. Select the item to remove.
3. Remove the selected item from the project, as [Table 4.6](#) explains.

**Table 4.6 Removing Selected Item from a Project**

On this host...	Do this...
Windows	Select <b>Edit &gt; Delete</b>
Solaris	Select <b>Edit &gt; Remove</b>
Linux	Select <b>Edit &gt; Remove</b>

The IDE removes the selected item from the project. For deleted files, the IDE updates all build targets that formerly used the file. For deleted build targets, the IDE deletes build-target information and leaves files intact.

## Removing files from a build target

1. Click the **Link Order**, **Segments**, or **Overlays** tab in the Project window.
2. Select the item to remove.
3. Remove the selected item from the active build target, as [Table 4.7](#) explains.

**Table 4.7 Removing Selected Item from Active Build Target**

On this host...	Do this...
Windows	Select <b>Edit &gt; Delete</b>
Solaris	Select <b>Edit &gt; Remove</b>
Linux	Select <b>Edit &gt; Remove</b>

The IDE removes the file from the build target, but leaves the file itself intact. The file can be re-assigned to other build targets in the project.

## Project Window

File, Group, Layout, and Target Management

---

---

### Moving Files/Groups/Layouts/Targets

Reposition files, groups, layouts, or build targets in the **Files**, **Design**, **Link Order**, or **Targets** pages with the cursor.

1. Select one or more files, groups, layouts, or build targets to move with the pointer.
2. Drag the selected items to a new position in the current page, using the focus bar as a guide.
3. Release the mouse button.

The IDE repositions the selected files, groups, layouts, or build targets to the new location.

---

**NOTE** In the **Link Order** page, repositioning files changes the link order that the **Make** command uses to build the final executable file.

---

---

### Renaming Files/Groups/Targets

The **Rename** command renames files, groups, or build targets in the project.

#### Rename files

1. Open the file to rename.
2. Select **File > Save As**.
3. Type a new filename in the **Object name** text box.
4. Click **Save**.

The IDE saves the file under the new name. The new filename appears in the Project window. Subsequent modifications affect the renamed file, leaving the original file intact.

#### Rename one or more groups

1. Click the **Files** tab in the Project window.
2. Select the group(s) to rename.
3. Press the **Enter** key.
4. Type a new name into the **Enter group name** text box of the **Rename Group** dialog box.

5. Click **OK**.

The IDE renames the group. For selections of more than one group, the **Rename Group** dialog box appears for each group.

## Rename build targets

1. Click the **Targets** tab in the Project window.
2. Select **Edit > targetname Settings**.
3. Select **Target Settings** in the **Target Settings Panels** list.
4. Type a new name in the **Target Name** text box.
5. Click **Save**.

The Project window displays the new build target name.

---

## Touching Files and Groups

The **Touch** command manually selects source files or groups for compilation during the next **Bring Up To Date**, **Make**, **Run**, or **Debug** operation. A red check mark in the **Touch** column of the Project window indicates a touched file.

1. Click the **Files** tab in the Project window.
2. Touch a source file or group for compilation.

Click the **Touch** column next to the file or group name.

OR

Select **Touch** from the **Interface** menu for the file.

A red check mark appears in the Touch column next to the file or group name.

## Touch all project files for recompiling

1. Perform the task explained in [Table 4.8](#).

**Table 4.8 Touching All Project Files for Recompiling**

On this host...	Do this...
Windows	Alt-click the Touch column.
Solaris	Alt-click the Touch column.
Linux	Alt-click the Touch column.

2. Red check marks appear next to all files and groups.

---

## Untouching Files and Groups

The **Untouch** command manually excludes source files or groups from compilation during the next **Bring Up To Date**, **Make**, **Run**, or **Debug** operation.

1. Click the **Files** tab in the Project window.
2. Untouch a source file or group to remove it from the compilation list.  
Click the red check mark in the **Touch** column next to the file or group name.

OR

Select **Untouch** from the **Interface** menu for the file.

The red check mark disappears from the **Touch** column next to the file or group name.

## Untouch all project files

1. Perform the task explained in [Table 4.9](#).

**Table 4.9 Untouching All Project Files**

On this host...	Do this...
Windows	Alt-click a red checkmark in the Touch column.
Solaris	Alt-click a red checkmark in the Touch column.
Linux	Alt-click a red checkmark in the Touch column.

2. The red checkmarks next to all files and groups disappear.

## Build-Target Management

These tasks help you manage build targets:

- Create a build target.
- Remove a build target.
- Set the default build target.
- Rename a build target.
- Configure build-target settings.

## Creating Build Targets

The **Create Target** command adds new build targets to a project.

1. Open the **Project** window.
2. Click the **Targets** tab in the Project window.
3. Select **Project > Create Target**.
4. Type a name in the **Name for new target** text box of the **New Target** dialog box.
5. Select the **Empty target** or **Clone Existing Target** option button as desired.
  - **Empty Target**—creates a new build target from scratch.
  - **Clone Existing Target**—duplicates an existing build target in the **New Target** dialog box.
6. Click **OK**.

The IDE adds the new build target to the project.

---

## Removing Build Targets from a Project

You can remove the build targets that are no longer required from the Project window.

1. Click the **Targets** tab in the Project window.
2. Select the item to remove.
3. Remove the selected build target, as explained in [Table 4.10](#).

**Table 4.10 Removing Selected Build Target**

On this host...	Do this...
Windows	Select <b>Edit &gt; Delete</b>
Solaris	Select <b>Edit &gt; Delete</b>
Linux	Select <b>Edit &gt; Delete</b>

The IDE removes the build target.

---

## Setting the Default Build Target

The CodeWarrior Project Manager can handle up to 255 build targets in a single project. One build target must be defined as the default target when more than one project is open. The default target is the target affected by project commands, such as **Make** and **Run**.

## The Project Menu

1. Select **Project > Set Default Target > buildtarget**.
2. A checkmark indicates the default target.

## Using the Project Window Toolbar

1. Enable the **Project** window.
2. Select the build-target name from the **Current Target** list box.

## The Targets page

1. Enable the **Project** window.
2. Click the **Targets** tab.
3. Click the desired build-target icon.  
The icon changes to indicate that the build target is now the default.

---

## Renaming Build Targets

The **Rename** command renames build targets in a project.

1. Click the **Targets** tab in the Project window.
2. Select **Edit > targetname Settings**.
3. Select **Target Settings** in the **Target Settings Panels** list.
4. Type a new name in the **Target Name** text box.
5. Save the new name.

The new build-target name appears in the Project window.

---

## Configuring Build Target Settings

The **Target Settings** panel options determine:

- The compiler used to process the project and produce object code



- The linker used to combine object code and produce a binary file
- The pre-linker and post-linker options that further process the object code
- The name assigned to a build target

Follow these steps to configure build-target settings.

1. Select **Edit > *targetname* Settings**.

The *targetname* value changes to reflect the name of the active build target in the project.

2. Select **Target Settings** from the **Target Setting Panels** list.
3. Specify target options as desired.
4. Save the new options

The panels available in the **Target Settings Panels** list update to reflect the settings in the **Target Settings** panel.



**Project Window**  
*Build-Target Management*

---

# Working with Files

---

This chapter explains how to work with files in the CodeWarrior™ IDE. Most computer programs use these file types:

- Text files—files that contain any type of text. Example text files include Read Me files and source files.
- Source files—files that contain source code only. Example source files include C++ files and Java files.

## Managing Files

These tasks manage files:

- Create a new file.
- Open an existing file.
- Save a file.
- Close a file.
- Print a file.
- Revert a file to a previously saved state.

---

### Creating Text Files (Windows)

The **New** command opens a window from which you create new text files. You can use new text files as source files in a project or as plain-text files.

1. Select **File > New**.  
The **New** window appears.
2. Click the **File** tab in the New window.
3. Select **Text File** in the list.
4. Type a filename in the **File name** text box.
5. Click **Set** to specify the location to save the new file.
6. Click **OK**.

The IDE creates the new text file and displays its contents in a new editor window.

## Working with Files

### Managing Files

---

**TIP** Use the **Customize IDE Commands** window to add the **New Text File** menu command to the **File** menu. Adding this menu command reduces the process of creating a new text file to one step: select **File > New Text File**. See [Customizing the IDE](#) for more information about using the Customize IDE Commands window.

---

---

## Creating Text Files (Solaris, Linux)

The **New Text File** command creates new text files. You can use new text files as source files in a project or as plain-text files.

Select **File > New Text File** to create a new text file. The IDE creates the new text file and displays its contents in a new editor window.

---

## Opening Source Files

The **Open** command opens one or more editable source files. Each open file appears in its own editor window.

**NOTE** The CodeWarrior editor cannot open files that prohibit editing. For example, the editor cannot open library files.

---

## From the File menu

1. Select **File > Open**.
2. Use the **Objects of** list box to select **All Files** (Windows).
3. Select a file.
4. Click **Open**.

The IDE displays the file in an editor window.

## From the Project window

1. Perform one of these:
  - Double-click a filename in the **Files** tab of the Project window,
  - Select a filename from the **Group** list box, or
  - Select an interface filename from the Interface menu.
2. The IDE finds, opens, and displays the selected source file in an editor window.

## From an Editor Window

1. Select an interface filename from the Interface menu.
2. The IDE selects, opens, and displays the source file in an editor window.

---

**NOTE** The menu does not show files that do not contain source code or are not yet compiled.

---

## Using Find and Open Files

1. In an editor window, select the name of an interface file, for example `studio.h`.
2. Select **File > Find and Open File**.  
The IDE finds, opens, and displays the source file in an editor window.

## To open a recent file or project

1. Select **File > Open Recent > *recentfilename* | *recentprojectname***.
2. The IDE finds and opens the selected source file or project.

---

## Saving Files

Use the **Save** command to save source files to ensure their continued existence between development sessions.

1. Select **File > Save**.

---

**NOTE** If the file has no title, a save dialog appears. Type a filename and specify a location for the file, then click **Save**.

---

2. The IDE saves the file.

---

## Saving All Modified Files

Use the **Save All** command to save the contents of all modified files. This command is useful for saving all files at the same time, rather than saving each file individually.

## Working with Files

### Managing Files

1. Save all currently opened and modified files, as explained in [Table 5.1](#).

**Table 5.1 Saving All Currently Opened and Modified Files**

On this host...	Do this...
Windows	Select <b>File &gt; Save All</b>
Solaris	Select <b>File &gt; Save All</b>
Linux	Select <b>File &gt; Save All</b>

2. The IDE saves the files.

## Saving File Copies

Use the **Save a Copy As** command to save a back-up copy of a project or file before modifying the original. Working on a copy of the original file provides a way to return to the original copy should modifications fail.

1. Select **File > Save A Copy As**.
2. Type a new filename in the **Object name** text box.
3. Click **Save**.

The IDE creates a copy of the file under the new name, leaving the original file unchanged.

## Closing Files

The **Close** command closes open source files. Close editor windows to close a file.

1. Select an editor window to close.
2. Close the file window.
  - Select **File > Close**, or
  - Click the close box.

**NOTE** The IDE displays an alert if the file is modified. The alert asks whether to save changes to the file.

The IDE closes the file window.

## Closing All Files

The **Close All** command closes all currently open files. This command is useful for closing all files at the same time, rather than closing each file individually.

1. Close all currently open files, as explained in [Table 5.2](#).

**Table 5.2 Closing All Currently Open Files**

On this host...	Do this...
Windows	Select <b>Window &gt; Close All</b> or <b>Window &gt; Close All Editor Windows</b> .
Solaris	Select <b>File &gt; Close All</b> or <b>File &gt; Close All Editor Windows</b>
Linux	Select <b>File &gt; Close All</b> or <b>File &gt; Close All Editor Windows</b>

2. The IDE closes the files.
- 

## Printing Source Files

The **Print** command prints the entire contents of a selected file window.

1. Activate the desired editor window to print.
2. Select **File > Print**.
3. Set print options in the **Print** dialog box.
4. Click OK or Print to print the file.

The IDE prints the selected file.

---

**NOTE** Use the same process to print the contents of a window, such as a Project window.

---

## Printing Source-File Selections

The **Print** command prints the currently selected contents in an editor window.

1. Activate the desired editor window to print.
  2. Select the portion of text to print.
-

## Working with Files

### *Managing Files*

---

3. Select **File > Print**.
  4. Set print options in the **Print** dialog box.
  5. Click **OK** or **Print**  
The IDE prints the selected text in the file.
- 

## Reverting Files

Use the **Revert** command to replace the current file with its previously saved version.

1. Select **File > Revert**. A dialog box appears confirming if you want to discard the changes.
2. Click **OK**.



# Dockable Windows

---

This chapter explains how to work with dockable windows in the Windows-hosted CodeWarrior™ IDE.

---

**NOTE** Dockable windows are not available on Linux and Solaris platforms.

---

Use dockable windows to do these tasks:

- Organize—attach, or *dock*, various windows to the edges of the screen for quick access.
- Group—dock windows of the same type to create a single window with multiple tabs, where each tab represents one of the original docked windows.

---

**NOTE** The dockable windows feature is available in Multiple Document Interface (MDI) mode only. This feature is not available in Floating Document Interface (FDI) mode. Toggle the [Use Multiple Document Interface](#) option in the [IDE Extras](#) preference panel to change between these two modes.

---

This chapter consists of these sections:

- [About Dockable Windows](#)
- [Working with Dockable Windows](#)
- [Dock Bars](#)

## About Dockable Windows

You can dock certain windows to the edges of the main frame window of the IDE. [Table 6.1](#) explains possible states for dockable windows. [Figure 6.1](#) shows the different window states.

In MDI mode, the IDE occupies a main window frame, or *client area*. IDE windows normally appear within this client area as you work. These windows are called *child windows* of the IDE's client area.

## Dockable Windows

### About Dockable Windows

---

**Table 6.1 Window States**

State	Characteristics
Docked	<ul style="list-style-type: none"> <li>• Attached to the left, right, top, or bottom edge of the client area</li> <li>• restricted to the client area</li> <li>• resizable</li> <li>• has a dock bar instead of a title bar</li> </ul>
Floating	<ul style="list-style-type: none"> <li>• Rests above all docked windows and MDI child windows</li> <li>• movable outside the client area, like a floating palette</li> <li>• has a thin title bar</li> <li>• does not have Minimize or Maximize buttons</li> </ul>
MDI Child	<ul style="list-style-type: none"> <li>• Normal child window of the client area, when running in MDI mode</li> <li>• restricted to the client area</li> </ul>

Figure 6.1 Window States

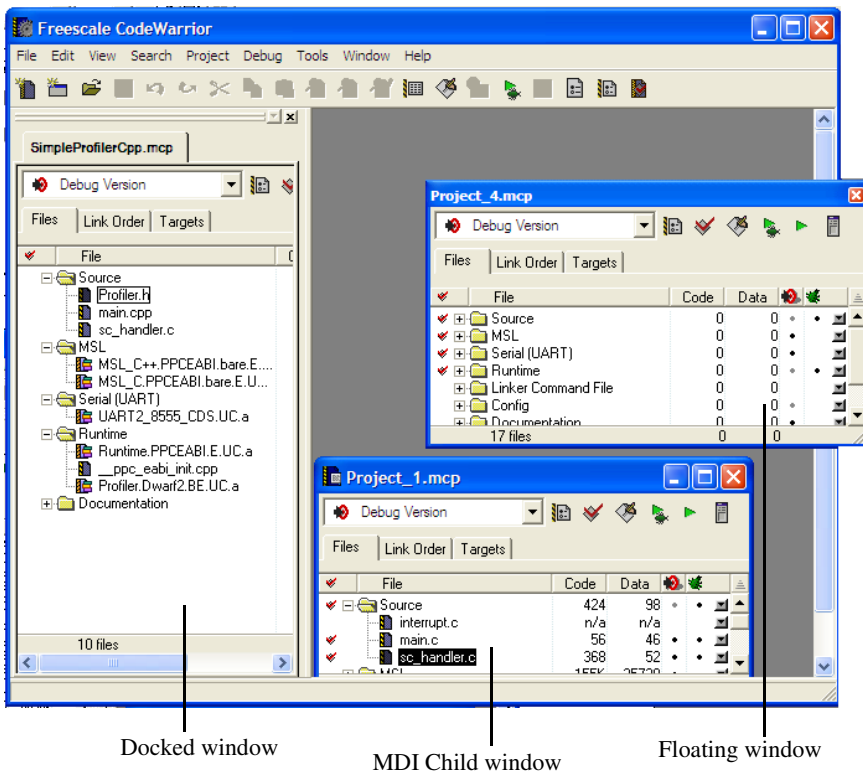

[Table 6.2](#) explains the difference between dockable windows and non-dockable windows. In this table, the term *non-modal* refers to a window that does not require your attention before allowing the IDE to proceed with other operations.

## Dockable Windows

Working with Dockable Windows

**Table 6.2 Differences between Dockable, Non-Dockable Windows**

Window Type	Required Criteria	Sample Windows
Dockable	All of these: <ul style="list-style-type: none"> <li>• non-modal</li> <li>• resizable</li> <li>• maximizable</li> </ul>	<ul style="list-style-type: none"> <li>• Thread</li> <li>• Project</li> <li>• Component Catalog</li> </ul>
Non-dockable	Any of these: <ul style="list-style-type: none"> <li>• modal</li> <li>• non-resizable</li> <li>• non-maximizable</li> </ul>	<ul style="list-style-type: none"> <li>• IDE Preferences</li> <li>• Find</li> <li>• About Box</li> </ul>

**NOTE** The default setting for project windows is to dock to an edge of the client area. You can undock these windows.

Compound windows that have more than one pane dock as a group. You cannot separately dock individual panes from these windows. For example, you can dock the Thread Window, but you cannot dock the Stack Crawl pane separately from the Thread Window.

## Working with Dockable Windows

You can dock windows in one of two ways:

- dragging a floating window to a docking position
- using a contextual menu to dock a window

You can resize docked windows and undock them to floating windows or MDI child windows.

This section explains how to perform tasks with dockable windows.

### Docking a Window by Using a Contextual Menu

Use a contextual menu to dock a floating window or MDI child window to one of the four edges of the client area.

1. Right-click the window title bar.  
A contextual menu appears.
2. Select **Docked** from the contextual menu.

---

**NOTE** The **Docked** command appears in the contextual menu for dockable windows only.

---

The window docks to an edge of the client area. You can resize the docked window or move it to a different edge of the client area.

---

## Docking a Window by Using Drag and Drop

You can drag a docked window or a floating window to one of the four edges of the client area to dock it.

1. Drag the window to one edge of the client area.  
Drag a floating window by its title bar. Drag a docked window by its dock bar.
2. A window outline appears near the client-area edge, showing the final position after you release the window.  
Use the outline as a visual cue that the IDE will dock the window. If an outline does not appear, you cannot dock the window.
3. Release the window to dock it to the edge.  
The window appears in the position indicated by the window outline.

---

## Docking Windows of the Same Kind

You can dock two or more windows of the same kind inside a single docked window. In this arrangement, tabs inside the single docked window represent each of the original docked windows. You can undock each tab individually from the single docked window.

1. Dock the first of two or more windows of the same kind to an edge of the client area.
2. Dock the second window to the same edge as the first window.  
Use the window outline that appears as a visual cue that the IDE will dock the second window to the same edge as the first window.
3. Dock subsequent windows to the same edge as the first window.  
Each additional docked window appears as a tab inside the first docked window. Click a tab to view its contents. The foremost tab appears in bold font.

[Figure 6.2](#) shows two projects represented as tabs in a single docked window.

## Dockable Windows

Working with Dockable Windows

**Figure 6.2 Two Projects in a Single Docked Window**

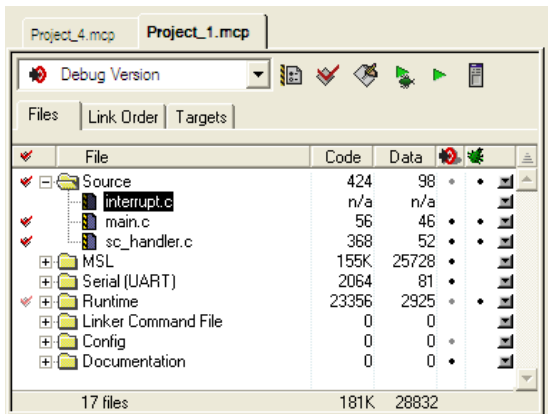

## Undocking a Window

Use a contextual menu to undock a window from an edge of the client area to a floating window or MDI child window.

1. Right-click the tab inside the docked window that represents the window you want to undock.

A contextual menu appears.

**Figure 6.3 Contextual Menu**

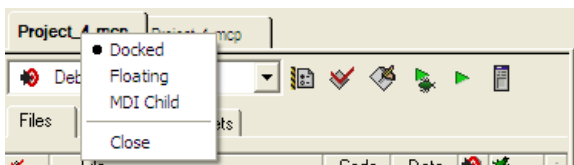

2. Select **Floating** or **MDI Child** from the contextual menu.
  - Floating—undock the window so that it becomes a floating window
  - MDI child—undock the window so that it becomes an MDI child window of the client area

The window undocks and becomes the chosen window type.

Alternately, double-click the tab to undock the corresponding window to a floating window.

---

## Floating a Window

Use a contextual menu to float a docked window or MDI child window.

1. Right-click the tab in the docked window or the title bar of the MDI child window.  
A contextual menu appears.
2. Select **Floating** from the contextual menu.

---

**NOTE** The **Floating** command appears in the contextual menu for floatable windows only.

---

The window becomes a floating window (that you can drag outside the client area).

Alternately, double-click the tab in a docked window to float its corresponding window.

---

## Unfloating a Window

Use a contextual menu to dock a floating window or make it an MDI child window.

1. Right-click the title bar of the floating window.  
A contextual menu appears.
2. Select **Docked** or **MDI Child** from the contextual menu.
  - Docked—dock the floating window
  - MDI child—unfloat the window so that it becomes an MDI child window

The window unfloats and becomes the chosen window type.

Alternately, drag the floating window to an edge of the client area to dock it.

---

## Making a Window an MDI Child

Use a contextual menu to make a docked window or floating window an MDI child window.

1. Right-click the tab in the docked window or the title bar of the floating window.  
A contextual menu appears.
2. Select **MDI Child** from the contextual menu.

The docked window or floating window becomes an MDI child window.

---

## Dockable Windows

### Dock Bars

---

## Suppressing Dockable Windows

Suppress dockable windows to drag a window to any location onscreen without docking it to an edge of the client area.

1. Hold down the Ctrl key while dragging or floating an MDI child window.  
The thin window outline that normally indicates docked-window placement becomes a heavy window outline. Use this heavy outline as a visual cue that the IDE suppresses dockable windows.
2. Release the window at its final position.  
The window appears in the position indicated by the heavy window outline.
3. Release the Ctrl key.

## Dock Bars

A docked window has a dock bar instead of a title bar. Use the dock bar to perform these tasks:

- move the docked window to a different edge of the client area
- collapse or expand view of the docked window
- close the docked window

[Figure 6.4](#) shows a dock bar.

**Figure 6.4 Dock Bar**



---

## Collapsing a Docked Window

If two or more distinct docked windows occupy the same edge of the client area, you can collapse one docked window to view contents of other docked windows.

1. Dock two or more windows to the same edge of the client area.  
The windows' contents must appear in separate docked windows, not as tabs in a single docked window.
2. Click the collapse button  on the dock bar of the docked window that you want to collapse.
3. The docked window collapses to hide its contents.



---

## Expanding a Docked Window

If you previously collapsed a docked window, you can expand it and view its contents.

1. Click the expand button on the dock bar: 
2. The docked window expands to restore its original view.

---

## Moving a Docked Window

Use the gripper in a docked window's dock bar to move the docked window to a different edge of the client area.

1. Drag the docked window by the gripper in its dock bar: 
2. Release the docked window at its new position.

---

## Closing a Docked Window

Close a docked window directly from its dock bar.

1. Click the close button on the dock bar: 
2. The docked window closes.

Re-opening the window restores its docked position.



## **Dockable Windows**

*Dock Bars*

---

# Workspaces

---

This chapter explains how to work with workspaces in the CodeWarrior™ IDE. Use workspaces to do these tasks:

- Organize—save the state of all windows onscreen for later reuse
- Migrate across computers—transfer your workspace from one computer to another

This chapter consists of these sections:

- [About Workspaces](#)
- [Using Workspaces](#)

## About Workspaces

A workspace stores information about the current state of the IDE. This information consists of the size, location, and the docked state (Windows) of the IDE windows. If you save a workspace during an active debugging session, the workspace also stores information about the state of debugging windows.

The IDE can use a default workspace, or it can use a workspace that you create. The IDE works with one workspace at a time. You can save and re-apply a workspace from one IDE session to the next.

## Using Workspaces

Use menu commands to perform these workspace tasks:

- save a new workspace
- open an existing workspace
- close the current workspace

---

### Using the Default Workspace

Use the default workspace to preserve IDE state from one session to the next. The IDE saves and restores the default workspace automatically.

1. Select **Edit > Preferences**.  
The IDE Preferences window opens.
2. Select **IDE Startup** in the **IDE Preference Panels** list.  
The IDE Startup preference panel appears.
3. Select the **On IDE Start** option.
  - **Restore Default Workspace**—the IDE saves its state at the time you quit, then restores that state the next time you launch the IDE
  - **Open Empty Text Document**—the IDE always launches with the same default state: no windows visible
  - **Do nothing**—the IDE does not save its state when you quit, or restore it the next time you launch the IDE.

---

### Saving a Workspace

Save a workspace to store information about the current state of onscreen windows, recent items, and debugging.

1. Arrange your workspace.  
Move windows to your favorite positions and start or finish a debugging session.
2. Select **File > Save Workspace As**.  
A **Save Workspace As** dialog box appears.
3. Enter a name for the current workspace.

---

**NOTE** Add the extension `.cww` to the end of the workspace name, for example, `myworkspace.cww`. This extension helps you readily identify the workspace file. The Windows-hosted IDE requires this extension to recognize the file as a CodeWarrior workspace.

---

4. Save the workspace to a location on your hard disk.

The IDE now uses your saved workspace. In subsequent programming sessions, you can open the workspace.

---

## Opening a Workspace

Open a workspace to apply its settings to the IDE.

1. Select **File > Open Workspace**.  
An **Open Workspace** dialog box appears.
2. Use this dialog box to browse through your hard disk and select a workspace file.  
These files end in the `.cww` extension.
3. Click **Open**.

The IDE opens the selected workspace and applies its settings.

---

## Saving Changes to a Workspace

Save changes to the current workspace.

1. Select **File > Save Workspace**.
  2. The IDE saves the changes to the current workspace.
- 

## Closing a Workspace

Close the current workspace after you finish working with it.

1. Select **File > Close Workspace**.
  2. The IDE closes the current workspace.  
You can now open a different workspace or quit the IDE.
- 

## Opening a Recent Workspace

You can open recently used workspace using the **Open Recent** submenu. The **IDE Extras** preference panel contains the **Recent Workspace** field that determines the number of recent workspaces the submenu lists.

1. Select **File > Open Recent**.  
A submenu appears. This submenu lists recently opened projects, files, and workspaces. A checkmark appears next to the active workspace.
  2. Select a recent workspace from the Open Recent submenu.  
The IDE applies the workspace that you select.
-



## **Workspaces**

*Using Workspaces*

---

# Creating Console Applications

---

This chapter explains how to work with console applications in the CodeWarrior™ IDE. Console applications provide these benefits to novice programmers:

- **Simplicity**—console applications are computer programs that use a simple text-mode interface. The simplicity of console-mode applications lets novice programmers to learn a programming language without having to learn graphical user interface programming at the same time.
- **Foundation**—understanding console applications provides the basis for more advanced computer programming. Advanced programmers readily understand console applications.

Read this chapter to learn more about typical tasks for working with console applications.

This chapter consists of these sections:

- [About Console Applications](#)
- [Creating Console Applications](#)

## About Console Applications

A console application is a simple, text-based computer program. Console applications do not usually employ a graphical user interface (GUI). Instead, the applications rely on plain-text input and output in a terminal window.

Console applications are ideal for novice programmers. The applications are easier to program because they lack a GUI. If problems arise, the programmer can use text-based feedback together with the debugger to correct problems.

## Creating Console Applications

Create a console application to begin working with a text-based computer program. The CodeWarrior IDE provides pre-configured project stationery for creating console applications. Project stationery simplifies the project-creation process. This section explains how to create a console application.

## Creating a Console Application

Use the **New** command to create a new project. The project stores information about the files in the console application.

1. Select **File > New**.

The **New** window appears.

2. Click the **Project** tab.

3. Select a project stationery file.

4. Enter a project name in the **Project name** field and add the `.mcp` extension.

For example, name the project `test.mcp`.

5. Click **Set**.

Save the project in the desired location.

6. Click **OK**.

The **New Project** window appears.

7. Select a specific stationery file.

8. Click **OK**.

The IDE creates a console application from the selected stationery. The Project window for the console application appears.

9. Expand the **Sources** group.

This group contains placeholder source files.

10. Remove placeholder source files.

For example, select `main.c` and select **Edit > Remove**.

11. Create a new source file, as explained in [Table 8.1](#).

**Table 8.1 Creating a New Source File**

On this host...	Do this...
Windows	Press Ctrl-N
Solaris	Press Meta-N
Linux	Press Meta-N (File > New Text File)

12. Enter source code.

For example, enter the source code of [Listing 8.1](#).



**Listing 8.1 Sample Source Code**

```
#include <stdio.h>
int main( void )
{
    printf("Hello World!");
    return 0;
}
```

13. Save the source file, as [Table 8.2](#) explains.

**Table 8.2 Saving the Source File**

On this host...	Do this...
Windows	Press Ctrl-S (File > Save)
Solaris	Press Meta-S
Linux	Press Meta-S (File > Save)

Enter a name for the source code. For example, enter `Hello.c`. Then click **Save**.

14. Select **Project > Add Hello.c to Project...**

The **Add Files** window appears.

15. Add the file to all build targets in the project.

Check all checkboxes to add the file to all build targets, then click **OK**.

16. Drag and drop the source file inside the **Sources** group.

17. Select **Project > Run**.

The IDE compiles, links, then runs the console application.



## **Creating Console Applications**

*Creating Console Applications*

---



# Editor

---

This section contains these chapters:

- [CodeWarrior Editor](#)
- [Editing Source Code](#)
- [Navigating Source Code](#)
- [Finding and Replacing Text](#)



# CodeWarrior Editor

---

This chapter explains how to work with the editor in the CodeWarrior™ IDE. Use the editor to perform these tasks:

- Manage text files—the editor includes common word-processing features for creating and editing text files. Sample text files include Read Me files and release notes.
- Manage source files—the editor includes additional features for creating and editing source files. The IDE processes source files to produce a program.

This chapter consists of these sections:

- [Editor Window](#)
- [Editor Toolbar](#)
- [Other Editor Window Components](#)

## Editor Window

Use the editor window to create and manage text files or source files. The window consists of these major parts:

- Editor toolbar
- Text-editing area
- Line and column indicator
- Pane splitter controls

[Figure 9.1](#) shows the editor window. [Table 9.1](#) explains the items in the editor window.

## CodeWarrior Editor

Editor Window

Figure 9.1 Editor Window

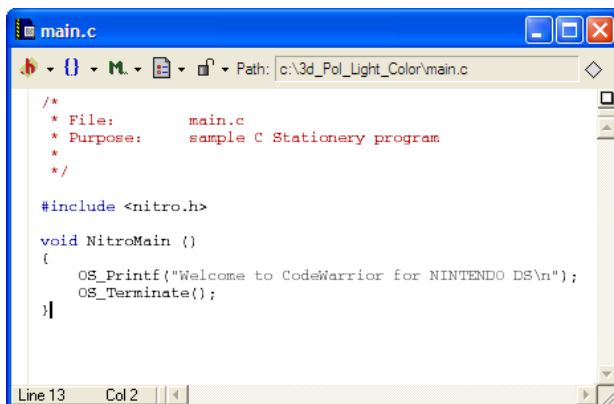

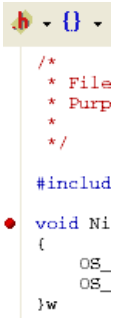



Table 9.1 Editor Window Items

Item	Icon	Explanation
<a href="#">Interfaces Menu</a>		Displays a list of referenced interface files or header files for the source file.
<a href="#">Functions Menu</a>		Displays a list of functions defined in the source file.
<a href="#">Markers Menu</a>		Displays a list of markers defined in the file.
<a href="#">Document Settings Menu</a>		Displays file-format options and a syntax-coloring toggle.
<a href="#">Version Control System Menu</a>		Displays a list of available Version Control System (VCS) commands. Choose a command to apply to the source file.
<a href="#">Path Caption</a>		Displays the complete path to the file.

**Table 9.1 Editor Window Items (continued)**

Item	Icon	Explanation
<a href="#">File Modification Icon</a>		<p>This icon indicates an unchanged file since the last save.</p> <p>This icon indicates a file with modifications not yet saved.</p>
<a href="#">Breakpoints Column</a>	 <pre> /*  * File  * Purp  */ #include void Ni {     OS_     OS_ }w </pre>	<p>Displays breakpoints for the file. Red dot indicates a user-specified breakpoint. Right-click on breakpoints column to bring up context menu.</p>
<a href="#">Text Editing Area</a>		<p>Shows the text or source-code content of the file.</p>
<a href="#">Line and Column Indicator</a>		<p>Displays the current line and column number of the text-insertion cursor. Click the Line and Column indicator to bring up the Line Number dialog box. Type the line number where you want to display the insertion cursor.</p>
<a href="#">Pane Splitter and Resize Controls</a>		<p>Drag or double-click to split the window into panes.</p> <p>Drag or double-click to resize or remove panes.</p>

## Editor Toolbar

Use the editor toolbar to complete these tasks:

- Open interface and header files
- Find function definitions
- Set and clear markers
- Modify file formats
- Control syntax coloring
- Execute version-control operations
- Determine a file's save state

This section explains how to expand and collapse the toolbar, and how to perform each toolbar task.

---

### Expanding and Collapsing the Editor Window Toolbar



To expand the editor window toolbar, click this icon in the right-hand top corner of the editor window.



To collapse the editor window toolbar, click this icon in the right-hand top corner of the editor window.

## Interfaces Menu

The Interfaces menu lists the source files included in the current source file.

See [Finding Interface Files](#) for information on navigating source code with the Interfaces menu.

## Functions Menu

The Functions menu lists the functions (routines) defined in the current file.

See [Locating Functions](#) for information on navigating source code with the Functions pop-up.

## Markers Menu

The Marker menu lists markers placed in the current file. Use markers to scroll to specific items in source code and find code segments by intuitive names.

See [Using Markers](#) for information on navigating source code with Markers.

---



## Document Settings Menu

The Document Settings menu shows whether the IDE applies syntax coloring to the window text, as well as the format in which the IDE saves the file.

---

### Using the Document Settings Menu

Use the **Document Settings** pop-up to toggle syntax coloring on or off for the current file, and set the EOL (end-of-line) format for saving a text file.

The EOL formats are:

- DOS: <CR><LF>
- UNIX: <LF>

### To toggle syntax coloring

- Select **Document Settings > Syntax Coloring**.

The editor window updates to display the new syntax color setting.

### To specify the EOL format for the file

- Select the EOL format for the file from the **Document Settings** pop-up.

The IDE applies the specified EOL format to the file the next time it gets saved.

## Version Control System Menu

In the editor window, the version control pop-up menu lists options provided by a version control system (VCS) compatible with the IDE. Use VCS to manage multiple versions of files. VCS packages are available separately for use with the IDE.

---

### Using the Version Control System Menu

Use the **Version Control System (VCS)** pop-up menu to access version control commands related to the editor window's file. If a version control system is not enabled for a project, the only item on the VCS menu is **Version Control Unavailable**.

- Select **VCS > VCScommand**

The IDE executes the VCS command.

## Other Editor Window Components

Use other editor window components to perform these tasks:

- Determine the path to a file.
- Determine the modification status of a file.
- Set or clear breakpoints.
- Edit text or source code.
- Find the text-insertion point.



This section explains these additional editor window components.

### Path Caption

The Path caption shows the path to the active file. The directory delimiters follow host conventions. For example, slashes separate directories for a path on a Windows computer and backslashes are used on Linux and Solaris.

### File Modification Icon

The File Modification icon indicates the save status of the file:

- The  icon indicates an unchanged file since the last **Save**.
- The  icon indicates a file with modifications not yet saved.

### Breakpoints Column

The Breakpoints column shows breakpoints defined in the current file. Each marker in the column indicates the line of source code at which the debugger suspends program execution.

### Text Editing Area

The text editing area behaves the same way as it does in a word processor. Enter text or source code, perform edits, and copy or paste selections.

## Line and Column Indicator

The Line and Column indicator shows the current position of the text-insertion point. Click the indicator to specify a line to scroll into view.

## Pane Splitter and Resize Controls

Use the pane splitter and resize controls to perform these tasks:

- Add panes to editor window.
- Adjust pane size.
- Remove panes from editor window.

This section explains how to perform each task.

---

### Adding Panes to an Editor Window

Use the **Pane Splitter** controls to add additional view panes in an editor window and view two or more sections of a source file at the same time.

1. Double-click or drag a **Pane Splitter control** to add a view pane.
  2. The IDE adds a new view pane to the editor window.
- 

### Resizing Panes in an Editor Window

Use the **Pane Resize** controls to resize the panes in an editor window.

1. Click and drag a vertical or horizontal **Pane Resize** control.
  2. The IDE resizes the selected view pane.
- 

### Removing Panes from an Editor Window

Use the **Pane Resize** controls to remove additional view panes from an editor window.

1. Remove an editor window pane.
    - Double-click the **Pane Resize** control to remove the pane, or
    - Click and drag the **Pane Resize** control to the left or top edge of the editor window.
  2. The IDE removes the view pane from the editor window.
-



## **CodeWarrior Editor**

*Other Editor Window Components*

---

# Editing Source Code

---

This chapter explains how to edit source code in the CodeWarrior™ IDE. The IDE provides these features to help you edit source code:

- Select and indent text—the editor can select text by line, routine, or rectangular selection. The editor also handles text indentation.
- Balance punctuation—the editor can find matching pairs of parentheses, brackets, and braces. Most programming languages, such as C++, produce syntax errors for punctuation that lacks a counterpart.
- Complete code—the IDE can suggest ways to complete the symbols you enter in a source file.

This chapter consists of these sections:

- [Text Manipulation](#)
- [Punctuation Balancing](#)
- [Code Completion](#)
- [Commenting Code using the Keyboard](#)

## Text Manipulation

Perform these tasks to manipulate text files:

- Select text
- Overstrike text
- Use virtual space
- Indent text

This section explains how to perform each task.

---

### Selecting Text in Editor Windows

The editor lets you select text in several ways while you edit source files.

**NOTE** Enable the **Left margin click selects line** option in the **Editor Settings** preference panel to use the right-pointing arrow cursor.

## Lines

Follow these steps to select a line of text:

- Triple-click anywhere on a line, or
- Click the right-pointing cursor in the left margin of the line.

## Multiple lines

Follow these steps to select multiple lines of text:

- Drag the cursor over several lines of text and release, or
- Position the cursor at the beginning of a selection range, then Shift-click the end of the selection range to select all text between the two points, or
- Drag the right-pointing cursor to select lines of text.

## Rectangular text selections

[Table 10.1](#) explains how to select rectangular portions of text.

**Table 10.1** Selecting a Rectangular Portion of Text

On this host...	Do this...
Windows	Alt-drag the cursor over the portion of text.
Solaris	Alt-drag the cursor over the portion of text.
Linux	Alt-drag the cursor over the portion of text.

## Entire routines

Follow these steps to select an entire routine:

1. Hold down the **Shift** key.
2. Select a function name from the **Function** list menu.

---

## Overstriking Text (Windows OS)

Use the Overstrike command to toggle between text insertion and text overwriting mode when entering text. Press the **Ins** key to toggle overstrike mode.

---

## Using Virtual Space

Use the Virtual Space feature to place the cursor anywhere in the white space of a line of source code and enter text at that position.

For example, consider the line of C++ code shown in [Listing 10.1](#).

### Listing 10.1 Sample C++ Source Code

---

```
void aFunction (const char * inMessage)           virtuallspace
```

---

Toggling virtual space changes the cursor behavior:

- enabled—clicking in the *virtuallspace* places the cursor at the location that you clicked. You can enter text at that location.
- disabled—clicking in the *virtuallspace* places the cursor after the last character on the line (in the example, after the closing parenthesis). To place the cursor beyond this character, you must repeatedly press the space bar on your keyboard.

To use virtual space, follow these steps:

1. Select **Edit > Preferences**.

The **IDE Preferences** window opens.

2. Select **Editor Settings** in the IDE Preference Panels list.

The Editor Settings preference panel appears.

3. Check the **Enable Virtual Space** checkbox.
  4. Click **Apply** and **OK** to save your changes to the preference panel.
  5. Close the IDE Preferences window.
- 

## Indenting and Unindenting Text Blocks

Use the **Shift Left** and **Shift Right** commands to shift a selected block of text to the left or right. You can indent or unindent one or more lines using these commands.

---

## Editing Source Code

### Punctuation Balancing

---

**NOTE** You can specify the amount of indentation in the **Tab size** text box in the **Fonts & Tabs** preference panel.

1. Select the text to be shifted.
2. Indent or unindent the selected text.
  - To unindent text: Select **Edit > Shift Left**.
  - To indent text: Select **Edit > Shift Right**.

## Symbol Editing Shortcuts

You can use the browser contextual menu to enhance source-code editing in the IDE. Use this menu to streamline text entry in editor windows. You can enter the first few letters of a function name, then use the browser contextual menu to complete the entry.

The IDE also provides these keyboard shortcuts with the browser enabled:

- **Find symbols with prefix**—find symbols matching the selected prefix
- **Find symbols with substring**—find symbols matching the selected substring
- **Get next symbol**—obtain the next symbol from the browser database
- **Get previous symbol**—obtain the previous symbol from the browser database

See the *IDE Quick Reference* card for more information about these keyboard shortcuts.

## Punctuation Balancing

Balance punctuation ensures that each opening parenthesis, bracket, or brace has a corresponding closing counterpart. This section explains how to balance punctuation.

---

### Balancing Punctuation

Use the **Balance** option when editing source code to make sure that every parenthesis (`()`), bracket (`[]`), and brace (`{ }`) has a mate.

1. Position the cursor between the suspect punctuation.
2. Check for the matching punctuation.
  - Select **Edit > Balance**.OR
  - Double-click the parenthesis, bracket, or brace character to check for a matching character.



From a text insertion point, the editor searches forward until it finds a parenthesis, bracket, or brace, then it searches in the opposite direction until it finds the matching punctuation. When double-clicking on a parenthesis, bracket, or brace, the editor searches in the opposite direction until it finds the matching punctuation.

When it finds a match, it highlights the text between the matching characters. If the insertion point is not enclosed or if the punctuation is unbalanced, the computer beeps.

## Toggling Automatic Punctuation Balancing

[Figure 10.1](#) shows the **Editor Settings**. Use these settings to enable or disable the punctuation balancing feature.

**Figure 10.1 Editor Settings (Balance While Typing)**

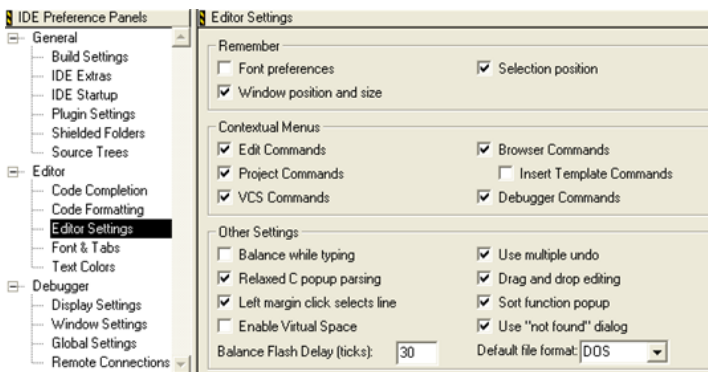

To toggle automatic punctuation balancing, follow these steps:

1. Select **Edit > Preferences**.  
This opens the **IDE Preferences** window.
2. In the **IDE Preference Panels** list, select **Editor Settings**.
3. In the **Other Settings** area of Editor Settings, check or clear the **Balance while typing** checkbox.

## Code Completion

Use code completion to have the IDE automatically suggest ways to complete the symbols you enter in a source file. By using code completion, you avoid referring to other files to remember available symbols.

## Editing Source Code

### Code Completion

---

C/C++ Code Completion will function more effectively when “Language Parser” is selected for the “Generate Browser Data From” option in the Build Extras target settings panel for a project. Java Code Completion is not affected by this setting.

## Code Completion Configuration

You can activate, deactivate, and customize code-completion operation. These tasks are associated with code completion:

- Activate automatic code completion
- Trigger code completion from the IDE menu bar
- Trigger code completion from the keyboard
- Deactivate automatic code completion

---

## Activating Automatic Code Completion

Activate automatic code completion to have the IDE display a Code Completion window that helps you complete the symbols you enter in source code. The **Code Completion** preference panel configures the Code Completion window behavior.

1. Select **Edit > Preferences**.

The **IDE Preferences** window appears.

2. Select the **Code Completion** preference panel in the **IDE Preference Panels** list.
3. Check the **Automatic Invocation** checkbox.

Selecting this option configures the IDE to automatically open the Code Completion window.

4. Enter a delay in the **Code Completion Delay** field.

This delay determines how long the IDE waits between the time you type a trigger character and the time the Code Completion window appears. If you perform any action during this delay time, the IDE cancels the Code Completion operation.

5. Save your preferences.

Click the **Save** or **Apply** button.

The Code Completion window now appears automatically to help you complete code in editor windows.

---

## Triggering Code Completion from the IDE Menu

Trigger code completion from the main menu to open the Code Completion window.

1. Bring forward an editor window.
2. Begin typing or place insertion point at end of source code that you want to complete.
3. Select **Edit > Complete Code**.  
The Code Completion window appears. Use it to complete the symbol at the insertion point.

## Triggering Code Completion from the Keyboard

To open code completion from the keyboard:

1. Bring forward an editor window.
2. Begin typing or place insertion point at end of source code to complete.
3. Press the appropriate code completion shortcut key combination.

[Table 10.2](#) lists the default code completion key bindings for each IDE host. Use the **Customize IDE Commands** panel to change these key bindings.

**Table 10.2 Code Completion Key Bindings**

Host	Get Next Completion	Get Previous Completion	Complete Code
Windows	Alt-/	Alt-Shift-/	Alt-.
Linux/Solaris	Control-/	Control-Shift-/	Control-.

## Deactivating Automatic Code Completion

Deactivate automatic code completion to prevent the IDE from displaying the Code Completion window as you edit source code. The **Code Completion** preference panel configures Code Completion window behavior.

You can still manually trigger code-completion functionality from the keyboard or from the main menu.

**NOTE** To dismiss the Code Completion window after it automatically opens, press the **Esc** key or click outside the active editor window.

1. Select **Edit > Preferences**.
2. Select the **Code Completion** preference panel in the **IDE Preference Panels** list.

## Editing Source Code

### Code Completion

3. Clear the [Automatic Invocation](#) checkbox.  
Clearing this option prevents the IDE from automatically opening the Code Completion window.
4. Save your preferences.  
Click the **Save** or **Apply** button.

## Code Completion Window



The Code Completion window displays possible symbols based on the context of the insertion point. For example, in Java you can complete code for any Java class, method, and variable from any package that has been imported or is being used elsewhere in the project.

[Figure 10.2](#) shows the Code Completion window. [Table 10.3](#) explains the items in the Code Completion window. [Table 10.4](#) explains the icons that appear in the Code Completion list.

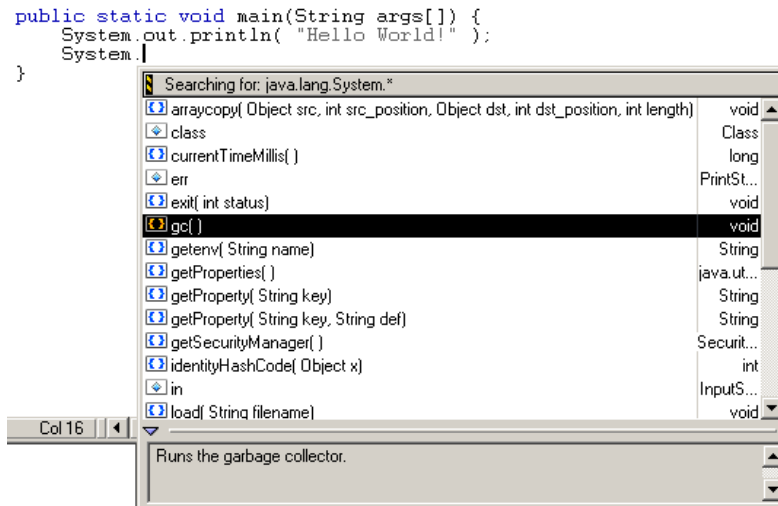









**Figure 10.2 Code Completion Window**



**Table 10.3 Code Completion Window Items**

Item	Icon	Explanation
Code Completion list		Lists available variables and methods or functions along with their corresponding return types or parameters. This list changes based on the context of the insertion point in the active editor window. Icons help distinguish items in the list.
Disclosure Triangle		Click to toggle display of Documentation pane for programming languages that support it.
Resize Bar		Drag to resize the Code Completion list and the Documentation pane.
Documentation pane		Displays summary information or documentation for the selected item in the Code Completion list. This pane appears only for programming languages that support summary information or documentation.

**Table 10.4 Code Completion Window Icons**

Icon	Code Type	Icon	Code Type
	Class		Method
	Function		Namespace
	Global Variable		None
	Language Keyword		Package
	Local Variable		Variable
	Constant		

## Navigating the Code Completion Window

Navigate the Code Completion window by mouse or keyboard. You can perform these tasks:

- Resize the window
  - Navigate the window by keyboard
  - Refine the Code Completion list by keyboard
1. Bring forward an editor window.
  2. Place the insertion point at the end of the source code to complete.
  3. Select **Edit > Complete Code** or use keyboard shortcut.  
The Code Completion window appears.
  4. Use the mouse to resize the Code Completion window (Windows).  
The new window size remains in effect until you refine the Code Completion list or close the Code Completion window. You refine the Code Completion list by typing additional characters in the active editor window.
  5. Use the keyboard to navigate the Code Completion list.  
[Table 10.5](#) explains how to navigate the Code Completion list by keyboard.

**Table 10.5 Navigating Code Completion List by Keyboard**

Key	Action
Up Arrow	Select the previous item
Down Arrow	Select the next item
Page Up	Scroll to the previous page
Page Down	Scroll to the next page

6. Use the keyboard to refine the Code Completion list.  
The Code Completion list updates as you add or delete characters in the active editor window. Continue adding characters to narrow the list, or delete existing characters to broaden the list. Press the Backspace key to delete characters.

---

## Selecting an Item in the Code Completion Window

Select an item in the Code Completion window to have the IDE enter that item in the active editor window at the insertion point.

1. Bring forward an editor window.
2. Place the insertion point at the end of the source code to complete.
3. Select **Edit > Complete Code**.
4. Select an item in the Code Completion list.
5. Enter the item into the active editor window.

Press the **Return** or **Enter** keys on the keyboard or double-click the item to have the IDE insert that item into the editor window.

---

## Completing Code for Data Members and Data Types

Complete code for data members for programming languages that support it. For a list of data members type the period (.) character and activate the code completion window. [Figure 10.3](#) shows an example of helping you select the correct data type depending on what code has been typed in the source file.

## Editing Source Code

### Code Completion

**Figure 10.3 Code Completion List of Data Types**

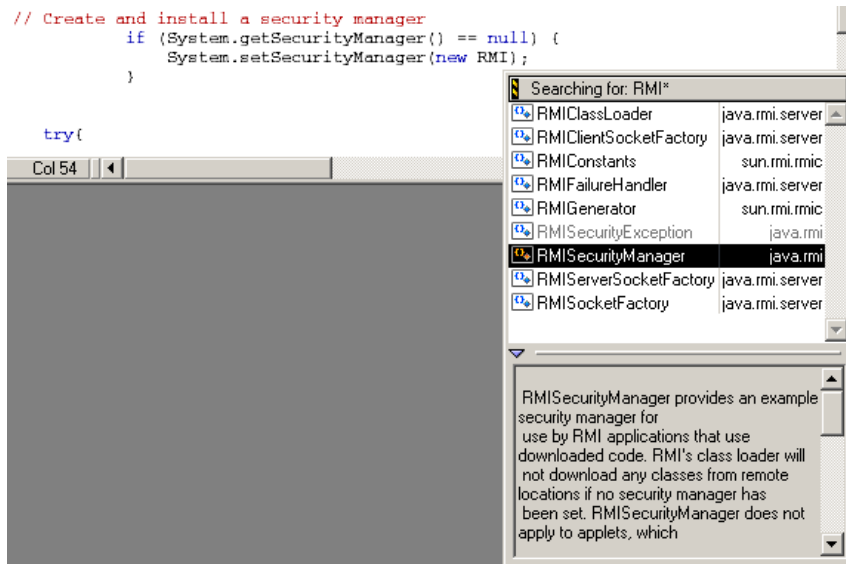

## Completing Code for Parameter Lists

Complete code for parameter lists for programming languages that support it. For example, you can complete code for parameter lists by typing the open parenthesis ( character.

1. Bring forward an editor window.
2. Place the insertion point at the end of the function or method to complete.
3. Type an open parenthesis to trigger a parameter-list.
4. The Code Completion window appears.

The upper portion of this window lists different (overloaded) versions of the function or method. The lower portion shows possible parameter lists for the selected function or method in the top portion. Use this window to complete the parameter list for the function or method.



Figure 10.4 Code Completion for Parameter Lists

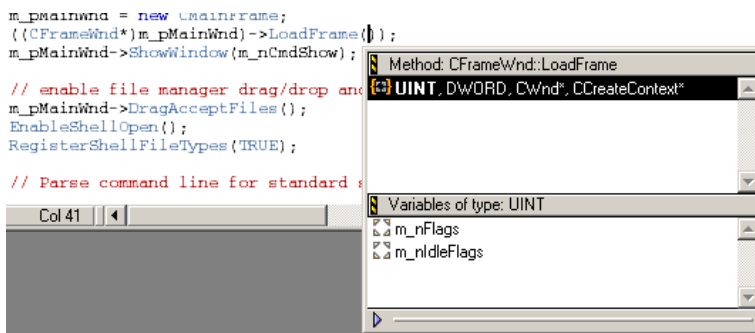

## Completing Code for Pragmas

In the Windows hosted, IDE you can display a list of pragmas in the code completion window.

1. Bring forward an editor window.
2. In your source file, type #pragma followed by a space.
3. Activate the code completion window (ctrl . or Alt .).

The code completion window will display list of pragmas.

Figure 10.5 Code Completion for Pragmas

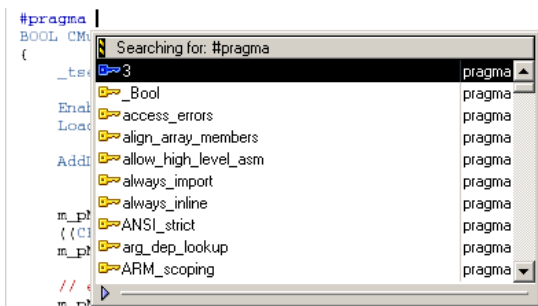

## Commenting Code using the Keyboard

The (Un)Comment Text Selection feature is implemented as follows depending upon how the text is selected:

- If a complete line or lines is selected `//...` will be used.
- If an uncomplete line or lines is selected then `/* ...*/` will be used.
- Text commented using `//...` is indented from the start of the line.
- If the number of lines selected exceeds the number of lines indented with `//...` then the selection will be commented with `//...` otherwise the selection will be uncommented.
- If nothing is selected, pressing "Ctrl + /" will result in the current line being commented or uncommented.

Comments using the form `/*yyy*/` can be uncommented in three ways:

- select the text with comment, i.e. `/*yyy*/`
- select the text without comment, i.e. `yyy`
- select the text with the comment and with blanks, i.e. `__/*yyy*/__`

# Navigating Source Code

---

This chapter explains how to navigate source code in the CodeWarrior™ IDE. Navigate source code to accomplish these tasks:

- Find specific items—the editor finds interface files, functions, and lines of source code.
- Go to a specific line—the editor can scroll to a specific line of source code.
- Use markers—the editor allows labelling of specific items of text. These labels, or markers, provide intuitive navigation of text.

Read this chapter to learn more about typical tasks for navigating source code.

This chapter consists of these sections:

- [Finding Interface Files, Functions, Lines](#)
- [Going Back and Forward](#)
- [Using Markers](#)
- [Symbol Definitions](#)

## Finding Interface Files, Functions, Lines

Find interface files, functions, and lines of source code to expedite programming. You can find these types of items:

- interface files
- functions
- lines of source code

### Finding Interface Files

Find interface (header) files referenced by the current source code. Some programming languages, such as C++, use interface files in conjunction with source code. Interface files typically define functions or objects used in the source code. Interface files also separate function or object declarations from implementations. This section explains how to find interface files.

## Navigating Source Code

### Finding Interface Files, Functions, Lines

---

#### Using the Interface Menu



Use the Interface menu in editor windows to open interface or header files referenced by the current file. The project file must be open for the Interface menu to operate.

1. Click the Interface menu.
2. Select the filename of the interface file that you want to open.

If found, the file is opened in an editor window. If not found, an alert sounds.

---

**NOTE** Only source code interface files can be opened. Libraries and pre-compiled header files can not be opened.

---

## Locating Functions

Find functions to expedite source-code editing. Most source files contain several functions that divide a complicated task into a series of simpler tasks. The editor allows scrolling to individual functions within the current source file. This section explains how to find functions.

#### Using the Functions Menu



Use the Functions menu in editor windows to quickly navigate to specific functions or routines in the current source file.

1. Click the Functions menu.
2. Select the function name to view.

The editor scrolls to display the selected function.

#### Alphabetizing Functions Menu with the Mouse and Keyboard

The default behavior of the Functions menu is to list functions in order of appearance in the source file. You can use the mouse and keyboard to list functions in alphabetical order.

[Table 11.1](#) explains how to use the mouse and keyboard to alphabetize functions in the Functions menu.

Table 11.1 Alphabetizing the Functions list

On this host...	Do this...
Windows	Ctrl-click the Functions menu.
Solaris	Alt-click the Functions menu.
Linux	Alt-click the Functions menu.

---

## Alphabetizing Functions Menu Order

The default behavior of the Functions menu is to list functions in order of appearance in the source file. You can check the [Sort function popup](#) checkbox in the **Editor Settings** preference panel to list functions in alphabetical order.

1. Open the **IDE Preferences** window.  
Select **Edit > Preferences**.
2. Select the **Editor Settings** preference panel.
3. Check the [Sort function popup](#) checkbox.
4. Save your modifications to the **Editor Settings** panel.

## Going Back and Forward

Go back and forward in source files to edit existing code. Most source files contain more than one screen of code. The editor always counts the number of lines in the source files. Go to a particular line to scroll a particular item into view.

---

### Going to a Line

Use the **Goto Line** command to navigate to a specific source line in an editor window if you know its number. Lines are numbered consecutively, with the first line designated as line 1. The **Line Number** control at the bottom of the editor window shows the line number where the text insertion point is positioned.

1. Open the **Line Number** dialog box.
  - Click the **Line and Column Indicator** control in bottom left corner of editor window, or
  - Select **Search > Go to Line**

## Navigating Source Code

### Using Markers

2. Type a line number in the **Goto line number** text box.
3. Click **OK**.

**NOTE** If a line number does not exist, the insertion point jumps to the last line of the source file.

## Using Markers

Markers behave like labels in the editor, identifying specific parts of source code. Use these tasks to work with markers:

- Add markers to a source file
- Navigate to a marker
- Remove some or all markers from a source file

## Remove Markers Window

Use the **Remove Markers** window to manage the use of destination markers in source files. [Figure 11.1](#) shows the Remove Markers window. [Table 11.2](#) explains the items in the window.

**Figure 11.1** Remove Markers Window

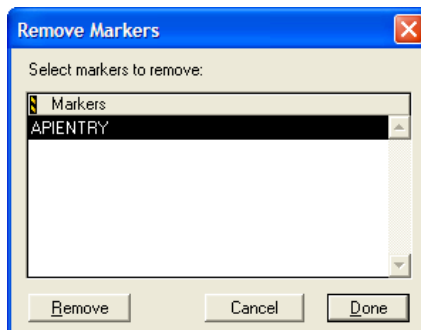

**Table 11.2 Remove Markers Window Items**

Item	Explanation
Markers list	Displays a list of all markers in the current source file.
Remove button	Click to remove all selected markers.
Cancel button	Click to close the Remove Markers window without applying changes.
Done button	Click to close the Remove Markers window and apply changes.

---

## Adding Markers to a Source File

Use the **Add marker** command to add a marker to a file to identify specific line locations by name.

1. Position the cursor on a line.
2. Select **Markers > Add marker**.
3. Type a name for the new marker.
4. Click **Add**.

The IDE adds the marker to the file.

---

## Navigating to a Marker

Once you add a marker, you can use the Markers menu to return to it later.

1. Select the marker name from the Markers menu.
  2. The editor window scrolls to display the selected marker.
- 

## Removing a Marker from a Source File

Use the **Remove Marker** command to remove one or more markers from a source file.

1. Select **Markers > Remove markers**
2. Select the marker name to remove from the list.
3. Click **Remove**.

The IDE removes the selected marker.

---

## Removing All Markers from a Source File

Use the **Remove markers** command to remove one or more markers from a source file.

1. Select **Markers > Remove markers**
2. Select all markers in the **Markers** list, as explained in [Table 11.3](#).

**Table 11.3** Selecting All Markers in Markers List

On this host...	Do this...
Windows	Shift-click each marker name in the list.
Solaris	Select <b>Edit &gt; Select All</b> .
Linux	Select <b>Edit &gt; Select All</b> .

3. Click **Remove**.  
 The IDE removes all markers.

## Symbol Definitions

You can find a symbol definition in your project's source code. Supported online reference viewers include HTMLHelp (Windows).

---

**TIP** You can also use the browser to look up symbol definitions.

---

**Figure 11.2** Find Definition

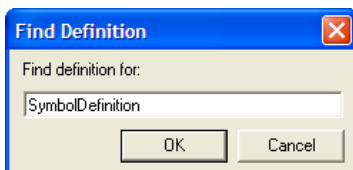

---

## Looking Up Symbol Definitions

To look up the definition of a selected symbol, follow these steps:



1. Select **Search > Find Definition**.
2. Enter the symbol definition.
3. Click **OK**.

CodeWarrior searches all files in your project for the symbol definition.

If CodeWarrior finds a definition, it opens an editor window and highlights the definition for you to examine.

---

**TIP** To return to your original location after viewing a symbol definition, press Shift-Ctrl B (Windows) or Meta-Shift B (Linux/Solaris). This key binding is equivalent to the **Go Back** menu command.

---

**Solaris and Linux** You can also use the **Find Reference** and **Find Definition & Reference** commands to look up symbol definitions. After you select a symbol and choose the Find Reference command, CodeWarrior searches the online documentation for the symbol definition. After you select a symbol and choose the Find Definition & Reference command, the IDE searches both the project files and the online documentation for the symbol definition. If CodeWarrior does not find a definition or reference, it notifies you with a beep.



## **Navigating Source Code**

*Symbol Definitions*

---

# Finding and Replacing Text

This chapter explains how to work with the find-and-replace features in the CodeWarrior™ IDE.

This chapter consists of these sections:

- [Single-File Find](#)
- [Single-File Find and Replace](#)
- [Multiple-File Find and Replace](#)
- [Search Results Window](#)
- [Text-Selection Find](#)
- [Regular-Expression Find](#)
- [Comparing Files and Folders](#)

## Single-File Find

Use the **Find** dialog box to search for text within a single file:

- The **Find** operation returns a single instance of matching text.
- The **Find All** operation returns all instances of matching text.

[Figure 12.1](#) shows the Find dialog box. [Table 12.1](#) explains the items in the Find dialog box.

**Figure 12.1 Find Dialog Box**

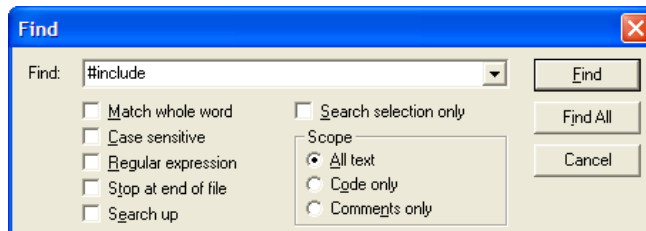

## Finding and Replacing Text

### Single-File Find

---

**Table 12.1 Find Dialog Box Items**

Item	Explanation
Find text/list box	Enter a search string. Click the arrow symbol to select a search string that you entered previously.
Find button	Click to start a search operation using the string in the Find text/list box.
Find All button	Click to search for all matches in the active editor window.
Cancel button	Click to close the Find dialog box without performing a search.
Match whole word checkbox	Check to search for whole-word matches only, ignoring matches within words. Clear to search for all matches of the search string, including matches within words.
Case sensitive checkbox	Check to consider text case during the search. The search operation distinguishes between a capital letter and the same letter in lower case. Clear to disregard text case during the search. The search operation does not distinguish between a capital letter and the same letter in lower case.
Regular expression checkbox	Check to treat the search string as a regular expression. Clear to treat the search string as plain text.
Stop at end of file checkbox	Check to stop a search at the end of a file and not wrap around to the beginning of the file. Clear to wrap around to the beginning of the file and continue a search. The search stops at the first match or at the current cursor position.
Search up checkbox	Check to perform a search operation back from the current selection. Clear to perform a search operation forward of the current selection
Search selection only checkbox	Check to search only the currently selected text and not the entire file. Clear to search the entire file.
All text option button	Select to search all text in the file.

Table 12.1 Find Dialog Box Items (*continued*)

Item	Explanation
Code only option button	Select to search only source code in the file.
Comments only option button	Select to search only comments in the file.

## Searching Text in a Single File

Use the **Find** command to search for text in the active editor window.

1. Select **Search > Find**.

The Find dialog box appears.

**NOTE** (Solaris and Linux) Use the **Customize IDE Commands** window to activate the **Find** menu command.

2. Enter search text into **Find** text/list box.
3. Set search options.
4. Click the **Find** or **Find All** button to start the search.

The IDE searches the current file until it finds a match or reaches the end of the search. A single match appears highlighted in the editor window, or multiple matches appear in a Search Results window. The IDE beeps if it does not find any matching text.

**TIP** If you clicked the Find button to start the search, select **Search > Find Next** to find the next match in the file.

## Single-File Find and Replace

Use the **Find and Replace** dialog box to perform these tasks:

- Search a single file.
- Replace found text in a single file.

[Figure 12.2](#) shows the Find and Replace dialog box. [Table 12.2](#) explains the items in the Find and Replace dialog box.

## Finding and Replacing Text

### Single-File Find and Replace

**Figure 12.2 Find and Replace Dialog Box**

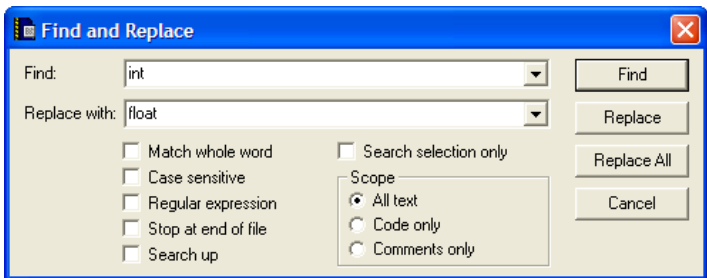

**Table 12.2 Find and Replace Dialog Box Items**

Item	Explanation
Find text/list box	Enter a search string. Click the arrow symbol to select a search string that you entered previously.
Replace with text/list box	Enter the replacement string. Click the arrow symbol to select a replacement string that you entered previously.
Find button	Click to start a search operation using the string in the Find text/list box.
Replace button	Click to replace the current match with the replacement string.
Replace All button	Click to replace all matches with the replacement string.
Cancel button	Click to close the Find and Replace dialog box without performing a search.
Match whole word checkbox	Check to search for whole-word matches only, ignoring matches within words. Clear to search for all matches of the search string, including matches within words.
Case sensitive checkbox	Check to consider text case during the search. The search operation distinguishes between a capital letter and the same letter in lower case. Clear to disregard text case during the search. The search operation does not distinguish between a capital letter and the same letter in lower case.
Regular expression checkbox	Check to treat the search string as a regular expression. Clear to treat the search string as plain text.

**Table 12.2 Find and Replace Dialog Box Items (continued)**

Item	Explanation
Stop at end of file checkbox	<p>Check to stop a search at the end of a file and not wrap around to the beginning of the file.</p> <p>Clear to wrap around to the beginning of the file and continue a search. The search stops at the first match or at the current cursor position.</p>
Search up checkbox	<p>Check to perform a search operation back from the current selection.</p> <p>Clear to perform a search operation forward of the current selection</p>
Search selection only checkbox	<p>Check to search only the currently selected text and not the entire file.</p> <p>Clear to search the entire file.</p>
All text option button	Select to search all text in the file.
Code only option button	Select to search only source code in the file.
Comments only option button	Select to search only comments in the file.

## Replacing Text in a Single File

Use the **Replace** command to replace matching text.

1. Select **Search > Replace** or **Search > Find and Replace**.

The Find and Replace dialog box appears.

2. Enter search text into the **Find** text/list box.
3. Enter replacement text into the **Replace with** text/list box.
4. Set search options.
5. Find and replace text:

- a. Click the **Find** button to search for matching text.

The IDE searches the current file until it finds a match or reaches the end of the search. A single match appears highlighted in the editor window. The IDE beeps if it does not find any matching text.

## Finding and Replacing Text

### *Multiple-File Find and Replace*

---

- b. Click the **Replace** or **Replace All** button to replace the matching text.

Click the Replace button to replace the current match. Click the Replace button repeatedly to replace subsequent matches. Click the Replace All button to replace all matching text in the file.

To replace consecutive matches, click the Find button to find the first match, then repeatedly click the Replace button. To replace one match at a time, or to replace non-consecutive matches, click the Find button to find a match, then click the Replace button as needed.

---

**TIP** If you clicked the Find button to start the search, select **Search > Find Next** to find the next match in the file.

---

## Multiple-File Find and Replace

Use the **Find in Files** window to perform these tasks:

- Search several files.
- Replace found text in multiple files, folders, symbolics files, or projects.
- Replace found text in files within a specific build target.

[Figure 12.3](#) shows the Find in Files window. [Table 12.3](#) explains the items in the window.



**Figure 12.3 Find in Files Window**

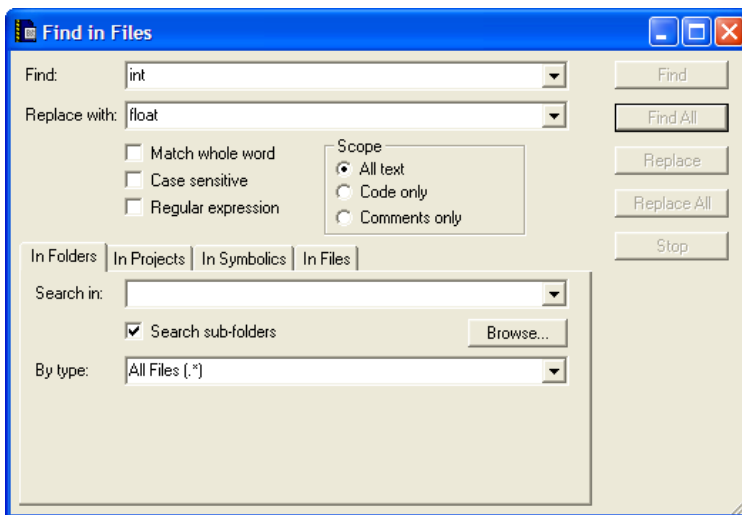

**Table 12.3 Find in Files Window Items**

Item	Explanation
Find text/list box	Enter a search string. Click the arrow symbol to select a search string that you entered previously.
Replace with text/list box	Enter the replacement string. Click the arrow symbol to select a replacement string that you entered previously.
Find button	Click to start a search operation using the string in the Find text/list box.
Find All button	Click to search for all matches in the selected items.
Replace button	Click to replace the current match with the replacement string.
Replace All button	Click to replace all matches with the replacement string.
Stop button	Click to stop the current operation.
Match whole word checkbox	Check to search for whole-word matches only, ignoring matches within words.  Clear to search for all matches of the search string, including matches within words.

## Finding and Replacing Text

### Multiple-File Find and Replace

**Table 12.3 Find in Files Window Items (continued)**

Item	Explanation
Case sensitive checkbox	Check to consider text case during the search. The search operation distinguishes between a capital letter and the same letter in lower case.  Clear to disregard text case during the search. The search operation does not distinguish between a capital letter and the same letter in lower case.
Regular expression checkbox	Check to treat the search string as a regular expression.  Clear to treat the search string as plain text.
All text option button	Select to search all text in the selected items.
Code only option button	Select to search only source code in selected items.
Comments only option button	Select to search only comments in selected items.
<a href="#">In Folders</a> tab	Click to bring forward the In Folders page. Use this page to search specific folders in the host file system.
<a href="#">In Projects</a> tab	Click to bring forward the In Projects page. Use this page to search active projects and build targets.
<a href="#">In Symbolics</a> tab	Click to bring forward the In Symbolics page. Use this page to search files containing symbolics (debugging and browsing) information generated by the IDE.
<a href="#">In Files</a> tab	Click to bring forward the In Files page. Use this page to search files contained in custom file sets.

## In Folders

Use the **In Folders** page to search folder contents for matching text. [Figure 12.4](#) shows the In Folders page. [Table 12.4](#) explains the items in the page.

**Figure 12.4 Find in Files Window, In Folders Page**

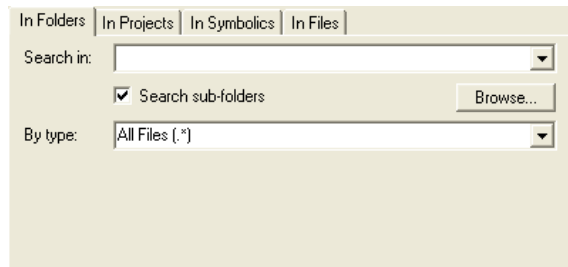

**Table 12.4 Find in Files Window, In Folders Items**

Item	Explanation
Search in text/list box	Enter the path to the folder that you want to search. Click the arrow symbol to select a path that you entered previously.
Browse button	Click to open a dialog box that lets you pick the folder that you want to search.
Search sub-folders checkbox	Check to search sub-folders of the selected folder.  Clear to search the selected folder only, ignoring any sub-folders it may contain.
By type text/list box	Enter the filename extensions of the files that you want to search. Click the arrow symbol to select a set of filename extensions. The search ignores files whose filename extensions do not appear in this text/list box.

## Searching for Text Across Multiple Folders

Use the **In Folders** page to search for text in folder contents.

1. Select **Search > Find in Files**.  
The Find in Files window appears.
2. Enter search text into the **Find** text/list box.
3. Enter replacement text into the **Replace with** text/list box.
4. Set general search options.

## Finding and Replacing Text

### Multiple-File Find and Replace

---

5. Set the **In Folders** page search options:
  - a. Enter a folder path into the **Search in** text/list box, or click the **Browse** button to select a folder.
  - b. Check or clear the **Search sub-folders** checkbox.
  - c. Enter filename extensions into the **By type** text/list box.
6. Find and replace text:
  - a. Click the **Find** or **Find All** button to search for matching text.
 

The IDE searches the specified folder contents until it finds a match or reaches the end of the search. A single match appears highlighted in an editor window, or multiple matches appear in a Search Results window. The IDE beeps if it does not find any matching text.
  - b. Click the **Replace** or **Replace All** button to replace the matching text.
 

Click the Replace button to replace the current match. Click the Replace button repeatedly to replace subsequent matches. Click the Replace All button to replace all matching text.

To replace consecutive matches, click the Find button to find the first match, then repeatedly click the Replace button. To replace one match at a time, or to replace non-consecutive matches, click the Find button to find a match, then click the Replace button as needed.

---

**TIP** If you clicked the Find button to start the search, select **Search > Find Next** to find the next match.

---

## In Projects

Use the **In Projects** page to search active projects and build targets for matching text. [Figure 12.5](#) shows the In Projects page. [Table 12.5](#) explains the items in the page.

**Figure 12.5 Find in Files Window, In Projects Page**

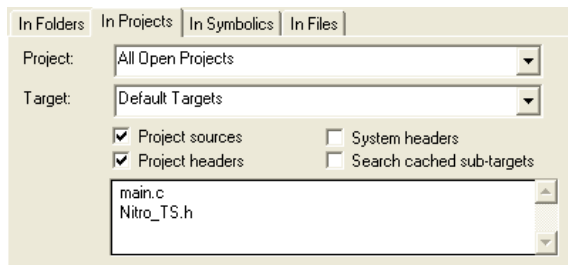

**Table 12.5 Find in Files Window, In Projects Items**

Item	Explanation
Project list box	Specify the projects that you want to search.
Target list box	Specify the build targets that you want to search.
Project sources checkbox	Check to search the source-code files of selected projects. Clear to ignore source-code files of selected projects.
Project headers checkbox	Check to search the header files of selected projects. Clear to ignore header files of selected projects.
System headers checkbox	Check to search system header files. Clear to ignore system header files.
Search cached sub-targets checkbox	Check to search sub-targets that the IDE cached for the selected build targets.  Clear to ignore the sub-targets that the IDE cached for the selected build targets.
File list	This list shows files that the IDE will search. To remove a file from this list, select it and press Backspace or Delete. To open a file in this list, double-click its name.

## Searching for Text across Multiple Projects

Use the **In Projects** page to search for text in active projects and build targets.

1. Select **Project > Make**.

The IDE updates the project data to correctly list source-code files, header files, and build targets in the **In Projects** page of the **Find in Files** window.

2. Select **Search > Find in Files**.

The Find in Files window appears.

3. Enter search text into the **Find** text/list box.
4. Enter replacement text into the **Replace with** text/list box.
5. Set general search options.
6. Set the **In Projects** page search options:

## Finding and Replacing Text

### Multiple-File Find and Replace

---

- a. Use the **Project** list box to specify the projects that you want to search.
  - b. Use the **Target** list box to specify the build targets that you want to search.
  - c. Check or clear the checkboxes to refine your search criteria.
  - d. Remove files from the File list as needed.
7. Find and replace text:
- a. Click the **Find** or **Find All** button to search for matching text.  
 The IDE searches the specified projects and build targets until it finds a match or reaches the end of the search. A single match appears highlighted in an editor window, or multiple matches appear in a Search Results window. The IDE beeps if it does not find any matching text.
  - b. Click the **Replace** or **Replace All** button to replace the matching text.  
 Click the Replace button to replace the current match. Click the Replace button repeatedly to replace subsequent matches. Click the Replace All button to replace all matching text.

To replace consecutive matches, click the Find button to find the first match, then repeatedly click the Replace button. To replace one match at a time, or to replace non-consecutive matches, click the Find button to find a match, then click the Replace button as needed.

---

**TIP** If you clicked the Find button to start the search, select **Search > Find Next** to find the next match.

---

## In Symbolics

Use the **In Symbolics** page to search files containing symbolics information for matching text. [Figure 12.6](#) shows the In Symbolics page. [Table 12.6](#) explains the items in the page.

**Figure 12.6 Find in Files Window, In Symbolics Page**

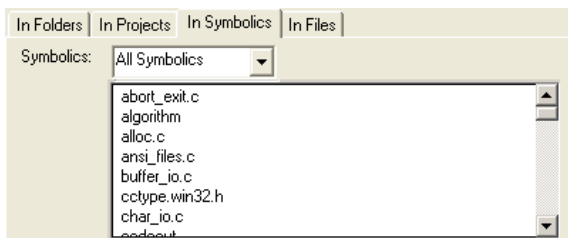

**Table 12.6 Find in Files Window, In Symbolics Items**

Item	Explanation
Symbolics list box	Specify the symbolics files that you want to search.
Symbolics list	This list shows the symbolics files that the IDE will search. To remove a file from this list, select it and press Backspace or Delete. To open a file in this list, double-click its name.

## Searching for Text across Multiple Symbolics Files

Use the **In Symbolics** page to search for text in symbolics files. You must generate browser data in order to search symbolics files.

1. Enable browser data for the build targets that you want to search.  
 Use the **Build Extras** target settings panel to **Generate Browser Data From** a compiler or language parser, then **Apply** or **Save** your changes. Configuring this option enables browser data.
2. Select **Project > Debug**.  
 Starting a debugging session causes the IDE to generate browser data for the project.

**NOTE** The IDE does not generate browser data for some files, such as libraries.

3. Select **Debug > Kill**.  
 The debugging session ends.
4. Select **Search > Find in Files**.  
 The Find in Files window appears.
5. Enter search text into the **Find** text/list box.
6. Enter replacement text into the **Replace with** text/list box.
7. Set general search options.
8. Set the **In Symbolics** page search options:
  - a. Use the **Symbolics** list box to specify the symbolics files that you want to search.
  - b. Remove symbolics files from the Symbolics list as needed.

## Finding and Replacing Text

### Multiple-File Find and Replace

---

9. Find and replace text:

- a. Click the **Find** or **Find All** button to search for matching text.

The IDE searches the specified symbolics files until it finds a match or reaches the end of the search. A single match appears highlighted in an editor window, or multiple matches appear in a Search Results window. The IDE beeps if it does not find any matching text.

- b. Click the **Replace** or **Replace All** button to replace the matching text.

Click the Replace button to replace the current match. Click the Replace button repeatedly to replace subsequent matches. Click the Replace All button to replace all matching text.

To replace consecutive matches, click the Find button to find the first match, then repeatedly click the Replace button. To replace one match at a time, or to replace non-consecutive matches, click the Find button to find a match, then click the Replace button as needed.

---

**TIP** If you clicked the Find button to start the search, select **Search > Find Next** to find the next match.

---

## In Files

Use the **In Files** page to search file sets for matching text. [Figure 12.7](#) shows the In Files page. [Table 12.7](#) explains the items in the page.

**Figure 12.7 Find in Files Window, In Files Page**

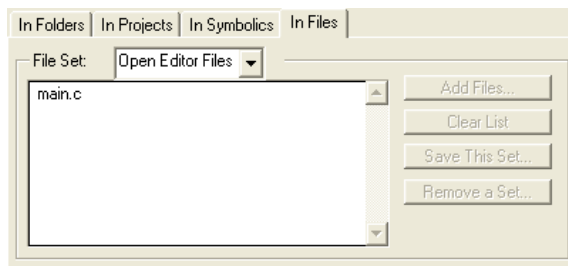



**Table 12.7 Find in Files Window, In Files Items**

Item	Explanation
File Set list box	Specify the file set that you want to search. Select <b>New File Set</b> to create a new set.
File Set list	This list shows the files that the IDE will search. To remove a file from this list, select it and press Backspace or Delete. To add files to this list, click the <b>Add Files</b> button, or drag and drop files and folders into the list. To open a file in this list, double-click its name.
Add Files button	Click to open a dialog box that lets you add files to the current file set. To enable this button, select from the File Set list box an existing file set or the <b>New File Set</b> option.
Clear List button	Click to clear the current File Set list. To enable this button, select from the File Set list box a file set that has at least one file.
Save This Set button	Click to save the current file set under a specific name. The file set must have at least one file. The name appears in the File Set list box. To enable this button, modify the current file set or select an existing file set from the File Set list box.
Remove a Set button	Click to open a dialog box that lets you remove file sets that you created previously. The removed file sets no longer appear in the File Set list box. To enable this button, select from the File Set list box an existing file set or the <b>New File Set</b> option.

## Searching for Text across Multiple Files

Use the **In Files** page to search for text in file sets.

1. Select **Search > Find in Files**.  
The Find in Files window appears.
2. Enter search text into the **Find** text/list box.
3. Enter replacement text into the **Replace with** text/list box.
4. Set general search options.
5. Set the **In Files** page search options:
  - a. Use the **File Set** list box to specify the file set that you want to search.
  - b. Use the buttons to manage the File Set list as needed.
  - c. Remove files from the File Set list as needed.

## Finding and Replacing Text

### Search Results Window

---

6. Find and replace text:

- a. Click the **Find** or **Find All** button to search for matching text.

The IDE searches the specified files until it finds a match or reaches the end of the search. A single match appears highlighted in an editor window, or multiple matches appear in a Search Results window. The IDE beeps if it does not find any matching text.

- b. Click the **Replace** or **Replace All** button to replace the matching text.

Click the Replace button to replace the current match. Click the Replace button repeatedly to replace subsequent matches. Click the Replace All button to replace all matching text.

To replace consecutive matches, click the Find button to find the first match, then repeatedly click the Replace button. To replace one match at a time, or to replace non-consecutive matches, click the Find button to find a match, then click the Replace button as needed.

---

**TIP** If you clicked the Find button to start the search, select **Search > Find Next** to find the next match in the file.

---

## Search Results Window



Use the **Search Results** window to explore multiple matches that the IDE finds. The IDE opens this window automatically after it finds multiple matches. Also use this window to stop searches in progress.

[Figure 12.8](#) shows the Search Results window. [Table 12.8](#) explains the items in the window.

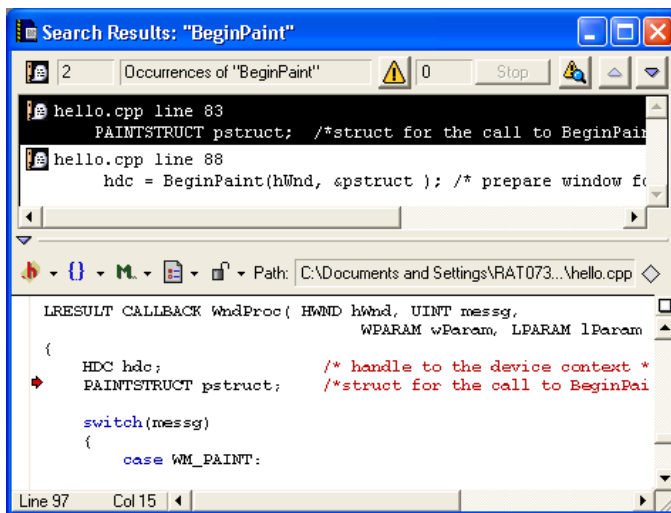
**Figure 12.8 Search Results Window**







**Table 12.8 Search Results Window Items**

Item	Icon	Explanation
Result Count text box		Shows the total number of search results.
Search Criteria text box	<input type="text" value='Occurrences of "static"'/>	Shows the search criteria.
Warnings button		Click to display compiler and linker warnings in the Results pane. The text box to the right of this button shows the total number of warnings.
Stop button	<input type="button" value="Stop"/>	Click to stop the search in progress.
Message Details button		Click to display full paths for the files listed in the search results.

## Finding and Replacing Text

### Text-Selection Find

**Table 12.8 Search Results Window Items** (*continued*)

Item	Icon	Explanation
Previous Result button		Click to select the previous search result.
Next Result button		Click to select the next search result.
Results pane		Lists individual search results.
Source Code pane disclosure triangle		Click to show or hide the Source Code pane.
Pane resize bar		Drag to resize the Results and Source Code panes.
Source Code pane		Shows the source code corresponding to the selected item in the Results pane. This pane operates the same as an editor window without pane-splitter controls.

## Text-Selection Find

After you use the **Find**, **Find and Replace**, or **Find in Files** windows to perform a successful search, you can use menu commands to apply the same search criteria to additional searches. This way, you do not have to open the windows again to use the same search criteria. You select text in the active editor window to define the search string.

### Using the Find Next Command

When searching for text, you can use the **Find Next** command to have the IDE find the next match:

1. Start a search with the **Find**, **Find and Replace**, or **Find in Files** windows.
2. After the IDE finds a match, select **Search > Find Next** to find a subsequent match.

---

**NOTE** Find Next always searches forward and ignores the Search up checkbox.

---

---

## Using the Find Previous Command

When searching for text, you can use the **Find Previous** command to have the IDE find the previous match. You must enable the Find Previous command in the **Customize IDE Commands** window.

1. Select **Edit > Commands and Key Bindings**.  
The Customize IDE Commands window opens.
2. Click the **Commands** tab in the Customize IDE Commands window.
3. Expand the **Search** item in the **Commands** pane tree structure.
4. Select the **Find Previous** item in the expanded list.  
Scroll as needed in order to see the Find Previous item. After you select the Find Previous item, its settings appear in **Details** pane.
5. Check the **Appears in Menus** checkbox.
6. Click **Save** to confirm your changes.  
The Find Previous command will appear in the **Search** menu in the main IDE menu bar.
7. Close the **Customize IDE Commands** window.  
You can now select the Find Previous command in the Search menu. You can also use the key binding associated with the command.

---

## Changing the Find String

Use the **Enter Find String** command to change the current find string.

1. Select the text that you want to use as the new find string.
2. Select **Search > Enter Find String**.  
The selected text replaces the find string that you specified in the **Find**, **Find and Replace**, or **Find in Files** windows.

You can now use the new find string to perform find and replace operations.

## Searching with a Text Selection

Use the **Find Selection** command to search the active editor window for selected text.

1. Select the text that you want to use as the search string.
2. Select **Search > Find Selection**.

The IDE searches the active editor window until it finds a match or reaches the end of the search. A single match appears highlighted in the editor window. The IDE beeps if it does not find any matching text.

You can also use the **Find Next** and **Find Previous** commands to search for additional matching text.

## Regular-Expression Find

Use regular expressions to search text according to sophisticated text-matching rules. A *regular expression* is a text string used as a mask for matching text in a file. To use regular expressions, check the **Regular expression** checkbox in the **Find**, **Find and Replace**, or **Find in Files** windows. Certain characters are operators with special meanings in a regular expression.

---

**TIP** For an in-depth description of regular expressions, refer to *Mastering Regular Expressions* by Jeffrey E.F. Friedl, published by O'Reilly & Associates, Inc. On a UNIX system, also refer to the man pages for `regex`.

---

[Table 12.9](#) explains the regular-expression operators that the IDE recognizes.

**Table 12.9 Recognized Regular-Expression Operators**

Operator	Name	Explanation
.	match any	Matches any single printing or non-printing character except <code>newline</code> and <code>null</code> .
*	match zero or more	Replaces the smallest/preceding regular expression with a sub-expression.
+	match one or more	Repeats the preceding regular expression at least once and then as many times as necessary to match the pattern.
?	match zero or one	Repeats the preceding regular expression once or not at all.

**Table 12.9 Recognized Regular-Expression Operators (*continued*)**

Operator	Name	Explanation
<code>\n</code>	back reference	Refers to a specified group (a unit expression enclosed in parentheses) in the find string. The digit <i>n</i> identifies the <i>n</i> th group, from left to right, with a number from 1 to 9.
<code> </code>	alternation	Matches one of a choice of regular expressions. If this operator appears between two regular expressions, the IDE matches the largest union of strings.
<code>^</code>	match beginning of line	Matches items from the beginning of a string or following a <code>\n</code> character. This operator also represents a NOT operator when enclosed within brackets.
<code>\$</code>	match end of line	Matches items from the end of a string or preceding a <code>\n</code> character.
<code>[...]</code>	list	Defines a set of items to use as a match. The IDE does not allow empty lists.
<code>(...)</code>	group	Defines an expression to be treated as a single unit elsewhere in the regular expression.
<code>-</code>	range	Specifies a range. The range starts with the character preceding the operator and ends with the character following the operator.

[Table 12.10](#) shows various examples of using regular expressions to match particular text in a text sample.

**Table 12.10 Regular Expression Examples**

Example Type	This regular expression...	...matches this text...	...in this text sample:
Matching simple expressions	<code>ex</code>	<code>ex</code>	<code>sample text</code>
	<code>[()][. ]stack[ ]</code>	<code>(.stack)</code>	<code>ADDR(.stack)</code>
Matching any character	<code>var.</code>	<code>var1</code> <code>var2</code>	<code>cout &lt;&lt; var1;</code> <code>cout &lt;&lt; var2;</code>
	<code>c.t</code>	<code>cut</code> <code>cot</code>	<code>cin &gt;&gt; cutF;</code> <code>cin &gt;&gt; cotG;</code>

## Finding and Replacing Text

### Regular-Expression Find

**Table 12.10 Regular Expression Examples (continued)**

Example Type	This regular expression...	...matches this text...	...in this text sample:
Repeating expressions	<code>s*ion</code>	ion ssion	information the session
	<code>s+ion</code>	sion ssion	confusion the session
Grouping expressions	<code>ris</code>	ris	surprise
	<code>r( i)s</code>	r is	theVar is
Choosing one character from many	<code>[b s]ag</code>	sag bag lag	sagging bag lagged
	<code>[[aeiou][0-9]</code>	[2 u9	cout << a[2] << u9;
	<code>[^b s]ag</code>	rag	sagging rag lagged
	<code>[-ab]V</code>	aV -V	aVal-Val;
Matching line beginnings and endings	<code>^([\t]*cout)</code>	cout cout	cout << "no tab";  cout << "tab";
	<code>(l*;) \$</code>	l; ;	a-ct; a = battLvl; b-ct;

## Using the Find String in the Replace String

Use the `&` operator to incorporate matching text into a replacement string. The IDE substitutes the matching text for the `&` operator. Use `\&` to indicate a literal ampersand in the replacement string.

[Table 12.11](#) shows examples of using the find string in the replace string of regular expressions.



**Table 12.11 Find String, Replace String Examples**

Find string	Replace string	Matching text	After replacement
var[0-9]	my_&	var1	my_var1
tgt	\&target	tgt	&target

## Remembering Sub-expressions

Use the `\n` construct to recall sub-expressions from the find string in the replacement string. The digit `n` ranges from 1 to 9 and represents the `n`th sub-expression in the find string, counting from left to right. Enclose each sub-expression in parentheses.

Consider these sample definitions:

- Find string: `\#define[ \t]+(.+)[ \t]+([0-9]+)`;
- Replace string: `const int \1 = \2;`
- Sub-expression `\1`: `(.+)`
- Sub-expression `\2`: `([0-9]+)`

These definitions show a replacement operation that recalls two sub-expressions. [Table 12.12](#) shows the result of applying these sample definitions to some text.

**Table 12.12 Remembering Sub-Expressions**

Before replacement	\1 matches this text	\2 matches this text	After replacement
<code>#define var1 10;</code>	var1	10	<code>const int var1 = 10;</code>
<code>#define a 100;</code>	a	100	<code>const int a = 100;</code>

## Comparing Files and Folders

The IDE can compare files or folder contents and graphically show you the differences between them. You can perform these tasks:

- Compare two files.
- Compare the contents of two folders.

You perform the comparison by specifying a *source* item and a *destination* item. You can apply or unapply the changes in the source item to the destination item.

## Comparison Setup

You use the **Compare Files Setup** window to enter information about the files or folders that you want to compare. [Figure 12.9](#) shows the Compare Files Setup window. [Table 12.13](#) explains items in the window.

**Figure 12.9 Compare Files Setup Window**

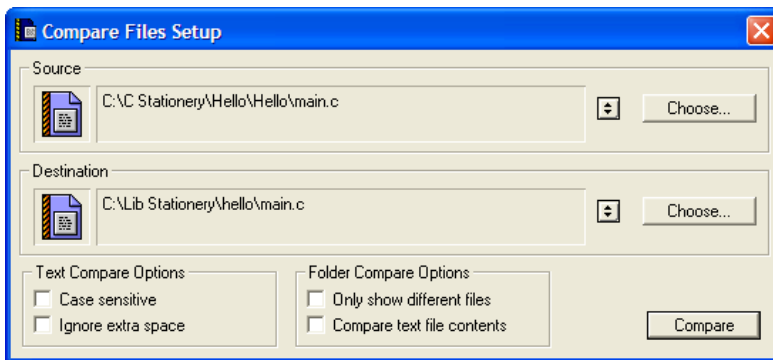

**Table 12.13 Compare Files Setup Window Items**

Item	Explanation
Source box	Click the <b>Choose</b> button to specify the source file or folder for the comparison, or drag and drop a file or folder into the box. Click the selector to the left of the Choose button to specify a file in an open editor window.
Destination box	Click the <b>Choose</b> button to specify the destination file or folder for the comparison, or drag and drop a file or folder into the box. Click the selector to the left of the Choose button to specify a file in an open editor window.
Case sensitive checkbox	<p>Check to consider text case during the compare operation. The comparison distinguishes between a capital letter and the same letter in lower case.</p> <p>Clear to disregard text case during the compare operation. The comparison does not distinguish between a capital letter and the same letter in lower case.</p>

**Table 12.13 Compare Files Setup Window Items (continued)**

Item	Explanation
Ignore extra space checkbox	<p>Check to consider extra spaces and tabs during the compare operation. The comparison distinguishes differences in the number of spaces and tabs in the compared files.</p> <p>Clear to disregard extra spaces and tabs during the compare operation. The comparison does not distinguish differences in the number of spaces and tabs in the compared files.</p>
Only show different files checkbox	<p>Check to have the <b>Folder Compare Results</b> window show only the differences between the compared folders. The <b>Files in Both Folders</b> pane stays blank.</p> <p>Clear to have the <b>Folder Compare Results</b> window show all files from the compared folders as well as the differences between those folders. The <b>Files in Both Folders</b> pane shows the common files between the compared folders.</p>
Compare text file contents checkbox	<p>Check to identify differences in terms of a byte-by-byte comparison of the files.</p> <p>Clear to identify differences in terms of only the sizes and modification dates of the files.</p>
Compare button	Click to compare the specified files or folders.

## Choosing Files to Compare

Use the **Compare Files** command to specify two files that you want to compare.

1. Select **Search > Compare Files**.  
The **Compare Files Setup** window appears.
2. Specify a source file for the comparison.  
Click the **Choose** button in the **Source** box or drag and drop the file into the Source box. To specify a file in an open editor window, click the selector in the Source box.
3. Specify a destination file for the comparison.  
Click the **Choose** button in the **Destination** box or drag and drop the file into the Destination box. To specify a file in an open editor window, click the selector in the Destination box.

## Finding and Replacing Text

### Comparing Files and Folders

---

4. Configure the checkboxes in the **Text Compare Options** group.  
Check the **Case sensitive** checkbox to distinguish between a capital letter and the same letter in lower case. Check the **Ignore extra space** checkbox to disregard extra spaces or tabs in the files.
5. Click the **Compare** button.  
The IDE performs the file comparison. The **File Compare Results** window appears.

---

## Choosing Folders to Compare

Follow these steps to specify two folders that you want to compare:

1. Select **Search > Compare Files**.  
The **Compare Files Setup** window appears.
2. Specify a source folder for the comparison.  
Click the **Choose** button in the **Source** box or drag and drop the folder into the Source box.
3. Specify a destination folder for the comparison.  
Click the **Choose** button in the **Destination** box or drag and drop the folder into the Destination box.
4. Configure the checkboxes in the **Text Compare Options** group.  
These options apply to the files inside the compared folders. Check the **Case sensitive** checkbox to distinguish between a capital letter and the same letter in lower case. Check the **Ignore extra space** checkbox to disregard extra spaces or tabs in the files.
5. Configure the checkboxes in the **Folder Compare Options** group.  
These options apply to the contents of the compared folders. Check the **Only show different files** checkbox to have the **Folder Compare Results** window show only the files that differ between the source folder and destination folder. Check this option to have the **Files in Both Folders** pane of the Folder Compare Results window stay blank.  
Check the **Compare text file contents** checkbox to have the IDE perform a content-based comparison of the text files in the compared folders. Check this option to have the Folder Compare Results window show differences in terms of file content instead of file sizes and modification dates.
6. Click the **Compare** button.  
The IDE performs the folder comparison. The **Folder Compare Results** window appears.

**CAUTION** The compare operation ignores folders matching the criteria that you specify in the **Shielded Folders** preference panel.

---

## File Comparison

The IDE file-comparison feature identifies additions, changes, and deletions between two text files. In addition, this feature allows you to apply the differences in the source file to the destination file.

You can also use this feature to merge changes between two versions of the same text file. Specify one version of the text file as the source file and the other version of the text file as the destination file. Then you can apply changes from the source file to the destination file. The destination file becomes the merged file.

After you use the **Compare Files Setup** window to specify two files for comparison, click the **Compare** button. The **File Compare Results** window appears. This window shows the differences between the source file and destination file. You can apply or unapply those differences to the destination file.

The File Compare Results window shows file differences in the form of highlighted portions of text. The highlighting tracks with the text as you scroll through the compared files.

[Figure 12.10](#) shows the File Compare Results window. [Table 12.14](#) explains the items in the window.

## Finding and Replacing Text

### Comparing Files and Folders

**Figure 12.10** File Compare Results Window

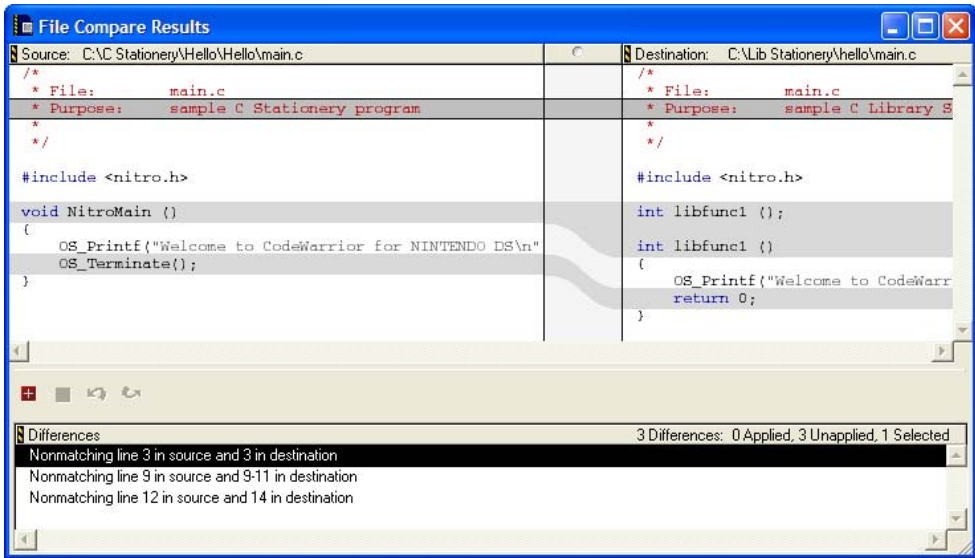

**Table 12.14** File Compare Results Window Items

Item	Icon	Explanation
Source pane	N/A	Shows the contents of the source file. You cannot edit the contents of this pane.
Destination pane	N/A	Shows the contents of the destination file. You can edit the contents of this pane.
Pane resize bar		Drag to resize the Source and Destination panes.
Apply button		Click to apply the selected Differences pane items to the destination file.
Unapply button		Click to unapply the selected Differences pane items from the destination file.
Undo button		Click to undo your last text edit in the Destination pane.

**Table 12.14 File Compare Results Window Items (continued)**

Item	Icon	Explanation
Redo button		Click to redo your last text edit in the Destination pane.
Differences pane	N/A	Shows the differences between the Source pane and the Destination pane. Select an item to highlight it in the Source and Destination panes. Applied items appear in an italicized font

## Applying File Differences

Use the **Apply Difference** command to apply the selected items in the **Differences** pane to the destination file.

**NOTE** You cannot alter the source file. You can change the destination file by applying differences from the source file or by editing the contents of the **Destination** pane.

1. Select the items in the Differences pane that you want to apply to the destination file.
2. Select **Search > Apply Difference** or click the Apply button in the **File Compare Results** window.

The **Destination** pane updates to reflect the differences that you applied to the destination file. The applied items in the Differences pane change to an italicized font.

**TIP** Use the **Customize IDE Commands** window to assign a key binding to the **Apply Difference** command. This way, you can use the keyboard to apply differences.

## Unapplying File Differences

Use the **Unapply Difference** command to unapply the selected items in the **Differences** pane from the destination file.

## Finding and Replacing Text

### Comparing Files and Folders

---

**NOTE** You cannot alter the source file. You can change the destination file by unapplying differences from the source file or by editing the contents of the **Destination** pane.

1. Select the items in the Differences pane that you want to unapply from the destination file.  
Items that you can unapply appear in an italicized font.
2. Select **Search > Unapply Difference** or click the Unapply button in the **File Compare Results** window.

The **Destination** pane updates to reflect the differences that you unapplied from the destination file. The unapplied items in the Differences pane no longer appear in an italicized font.

**TIP** Use the **Customize IDE Commands** window to assign a key binding to the **Unapply Difference** command. This way, you can use the keyboard to unapply differences.

## Folder Comparison

The IDE folder-comparison feature identifies the differences between the contents of two folders. It reports the files in both folders, the files only in the source folder, and the files only in the destination folder.

You can also use this feature to analyze the differences between two different releases of a folder of software. Specify one release of the software folder as the source folder and the other release of the software folder as the destination folder. Then you can analyze the differences between the source and destination folders.

After you use the **Compare Files Setup** window to specify two folders for comparison, click the **Compare** button. The **Folder Compare Results** window appears and shows the differences between the source folder and destination folder.

The Folder Compare Results window shows folder differences in the form of three panes. Italicized items in these panes indicate non-text files.

[Figure 12.11](#) shows the Folder Compare Results window. [Table 12.15](#) explains the items in the window.



**Figure 12.11 Folder Compare Results Window**

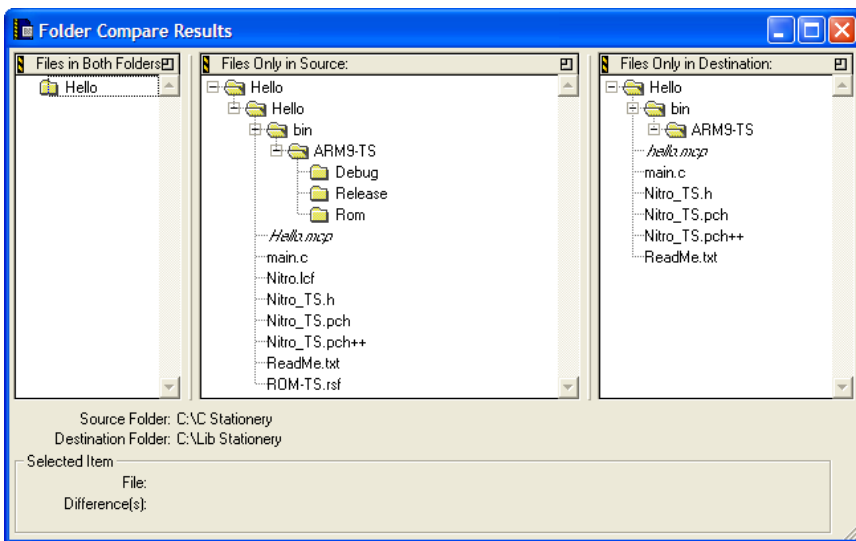

**Table 12.15 Folder Compare Results Window Items**

Item	Icon	Explanation
Pane Expand box		Click to enlarge the pane to fill the window.
Pane Collapse box		Click to reduce an expanded pane to its original size.
Pane resize bar		Drag to resize the panes on either side of the bar.
Files in Both Folders pane	N/A	Shows the items that are in both the source folder and the destination folder. A bullet next to an item indicates that the item content differs between the two folders.
Files Only in Source pane	N/A	Shows the items that are in the source folder only.

## Finding and Replacing Text

### Comparing Files and Folders

**Table 12.15 Folder Compare Results Window Items (continued)**

Item	Icon	Explanation
Files Only in Destination pane	N/A	Shows the items that are in the destination folder only.
Selected item group	N/A	Shows file and difference information for the selected item in the window panes.

## Examining Items in the Folder Compare Results Window

You can use the **Folder Compare Results** window to open text files and compare file differences.

Double-click a text file to view and change its contents in an editor window.

A file whose contents differ between the source and destination folders has a bullet next to its name. Double-click the file to open a **File Comparison Results** window. Use this window to examine the differences between the file contents.

# Browser

---

This section contains these chapters:

- [Using the Browser](#)
- [Using Class Browser Windows](#)
- [Using Other Browser Windows](#)
- [Using Browser Wizards](#)



# Using the Browser

---

This chapter explains how to work with the browser in the CodeWarrior™ IDE. Use the browser to perform these tasks:

- Generate a browser database—the browser stores the information collected about the symbols in a browser database for the project. You can generate browser data from the compiler or the language parser.
- Collect symbol information—symbols include functions, variables, and objects. Enable the browser to collect information about the symbols in a project.

Read this chapter to learn more about typical tasks for working with the browser.

This chapter consists of these sections:

- [Browser Database](#)
- [Browser Symbols](#)

## Browser Database

The browser database contains information about symbols in a program, which include (depending on program language) global variables, functions, classes, and type declarations, among others.

Some IDE windows require that the project contains a browser database. For example, the **Class Hierarchy** window only displays information for a project that contains a browser database. This section explains how to configure a project to generate its browser database.

---

**NOTE** Generating a browser database increases the project's size. To minimize the project's size, generate the browser database only for targets you frequently use.

---

## Browser Data

Browser data contains symbolic and relationship information about the project code. The browser uses this data to access the code information.

## Using the Browser

### Browser Database

Use the **Generate Browser Data From** list box (Figure 13.1) in the **Build Extras** target settings panel to enable and disable browser data generation. This list box provides these options, which determine how the IDE generates browser data:

- **None**—The IDE does not generate browser data. Use **None** to *disable* browser data and speed up compilation (with no browser features).
- **Compiler**—The Compiler generates the browser data. When you select **Compiler**, the compilation process slows down, but the compiler generates the most accurate browser data.
- **Language Parser**—The Code Completion plug-in associated with the project’s programming language generates the browser data.

**Figure 13.1** Generate Browser Data From Menu

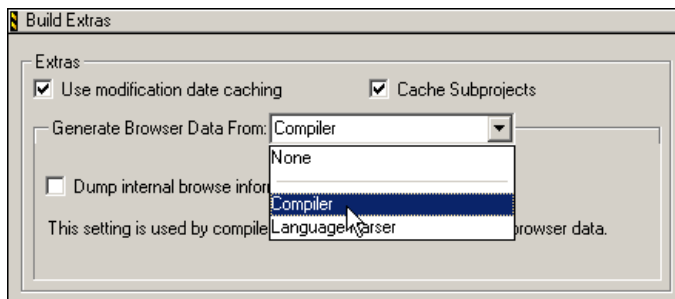

## Generating Browser Data

You can select an option in the **Generate Browser Data From** list box to specify what the IDE should use to generate browser data for a project file.

To generate browser data, follow these steps:

1. Select **Edit > Target Settings**.
2. From the **Target Settings Panels** list, select **Build Extras**.
3. Select **Compiler** or **Language Parser** from the **Generate Browser Data From** list box.

**NOTE** Some compilers do not generate browser data.

- a. **Compiler**—The compiler generates browser data and the **Dump internal browse information after compile** checkbox appears in the **Build Extras** panel.

If you check **Dump internal browse information after compile** checkbox, the generated browser data appears in a log window after you compile a file.

- b. **Language Parser**—The **Code Completion** plug-in associated with the project's programming language generates the browser data. Browser data and the #include pop-up window update as you edit.

---

**NOTE** Select Language Parser for C/C++ code completion.

---

The **Prefix** and **Macro** files ([Figure 13.2](#)) are applicable to C/C++ Code Completion.

**Figure 13.2 Generate Browser Data From Language Parser**

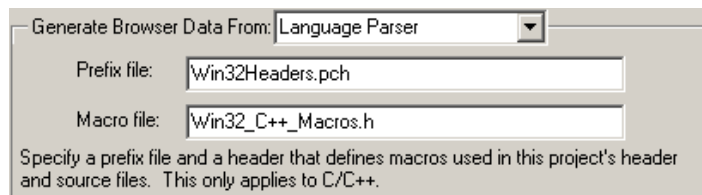

- **Prefix** file—Similar to that used in the **C/C++ Language Settings** panel, the Prefix file contains header files that help the C/C++ Code Completion plug-in parse code. The Prefix file should only include text files (not pre-compiled header files).
  - **Macro** file—Contains C/C++ macro files that help the Code Completion plug-in resolve any `#ifdefs` found in the source code or in the header files.
4. If you have selected **Compiler**, select **Project > Bring Up To Date** or **Make**.  
The IDE generates browser data for the project.  
If you have selected **Language Parser**, the IDE generates browser data in the background.

---

## Disabling Browser Data

Select **None** to disable browser data and stop the IDE from generating browser information for the project.

1. Select **Edit > Target Settings**.
2. Select **Build Extras** from the **Target Settings Panels** list.
3. In the **Generate Browser Data From** list box, select **None**.
4. Click **Save**.
5. Select **Project > Make**.

The IDE stops generating browser information.

## Browser Symbols

Navigate browser symbols to open browser views, find symbol definitions, and examine inheritance.

You can navigate browser symbols in these ways:

- Use the Browser contextual menu to open various browser windows for a selected symbol.
- Double-click a symbol name in the Class Browser window to open the file that contains the declaration of that symbol.
- Use the class hierarchy windows to determine the ancestors or descendants of a selected symbol.

## Browser Contextual Menu

Use the IDE's browser contextual menu to enhance source-code editing in the IDE. Use this menu to streamline text entry in the editor windows. You can enter the first few letters of a function name, then use the browser contextual menu to complete the entry.

---

### Using the Browser Contextual Menu

1. Open the browser contextual menu, as explained in [Table 13.1](#).

**Table 13.1** Opening Browser Contextual Menu

On this host...	Do this...
Windows	Right-click a symbol name.
Solaris	Click and hold on a symbol name.
Linux	Click and hold on a symbol name.

2. Select a command from the contextual menu.

---

### Identifying Symbols in Browser Database

As a shortcut, you can use browser coloring to help recognize if a symbol resides in the browser database. When you activate a browser, you can see browser-database symbols because they appear in the editor and browser windows according to the colors you select.



---

**TIP** The default color setting is identical for all eight types of browser-database symbols. You can choose a different color for each symbol type.

---

To change the browser symbol colors the editor uses, follow these steps:

1. Select **Edit > Preferences**.
2. Select the **Text Colors** panel from the **IDE Preference Panels** list.
3. Check the **Activate Syntax Coloring** checkbox.
4. Check the **Activate Browser Coloring** checkbox.
5. Click the color swatch next to the symbol name to set that symbol's color.
6. Click **Save**.



## Using the Browser

*Browser Symbols*

---

# Using Class Browser Windows

---

This chapter explains how to work with the Class Browser windows in the CodeWarrior™ IDE. Use the Class Browser to perform these tasks:

- View browser data—the class browser collects information about the elements of a computer program. Such elements include functions, variables, and classes. The class browser displays these elements in organized lists.
- Show data relationships—the class browser shows the relationships between classes, data members, and methods. The class browser also updates the display to reflect changes in class scope.

Read this chapter to learn more about typical tasks for working with Class Browser windows.

This chapter consists of these sections:

- [Class Browser window](#)
- [Classes Pane](#)
- [Member Functions Pane](#)
- [Data Members Pane](#)
- [Source Pane](#)
- [Status Area](#)

## Class Browser window

Use the Class Browser window to view information about the elements of a computer program. This section explains how to use the Class Browser window to view browser data.

[Figure 14.1](#) shows the Class Browser window. [Table 14.1](#) explains the items in the window. [Table 14.2](#) explains the options in the Browser Access Filters list box.

## Using Class Browser Windows

Class Browser window

Figure 14.1 Class Browser Window

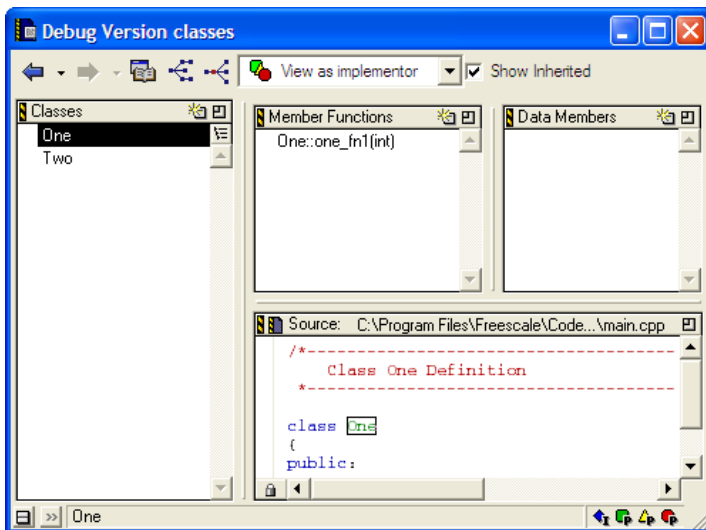

Table 14.1 Class Browser Window Items

Item	Icon	Explanation
Go Back button		Click to return to the preceding browser view.
Go Forward button		Click to move to the succeeding browser view.
Browser Contents button		Click to open the Browser Contents window.
Class Hierarchy button		Click to open the Multi-class Hierarchy window.
Single Class Hierarchy Window button		Click to open the Single-class Hierarchy window for the selected class.
Browser Access Filters list box		Select filters for displaying items in class-browser panes.



**Table 14.1 Class Browser Window Items (*continued*)**

Item	Icon	Explanation
Show Inherited		Select to show inherited items in the <a href="#">Member Functions Pane</a> and <a href="#">Data Members Pane</a> . Clear to hide inherited items from these panes.
<a href="#">Classes Pane</a>		Lists all classes in the project browser database.
<a href="#">Member Functions Pane</a>		Lists all member functions defined in the currently selected class.
<a href="#">Data Members Pane</a>		Lists all data members defined in the selected class.
<a href="#">Source Pane</a>		Displays source code for the currently selected item.
<a href="#">Status Area</a>		Displays various status messages and other information.
Display toggle buttons	Alphabetical Hierarchical	Toggles the Classes display between alphabetical and hierarchical listings.
New Item button		Opens wizards to create new items (For example, classes, data members, and member functions).
Pane Expand box		Expands the pane to the width of the full window.
Pane Collapse Box		Collapses the pane to its original size.
Hide Classes Pane button		Hides the Classes pane from the Class Browser window.
Show Classes Pane button		Displays the Classes pane in the Class Browser window.
Class Declaration button		Opens a window that shows declarations for all classes in the project.







## Using Class Browser Windows

### Class Browser window

**Table 14.1 Class Browser Window Items (continued)**

Item	Icon	Explanation
Open File button		Opens the current source file in a new editor window.
VCS list pop-up		With a version control system enabled, select the version-control command to execute on the displayed source file.

**Table 14.2 BrowserAccess Filters**

Filter	Icon	Show items with this access:		
		Public	Private	Protected
View as implementor		•	•	•
View as subclass		•		•
View as user		•		
Show public		•		
Show protected				•
Show private			•	

## Viewing Class Data from Browser Contents Window

To view class data for a project in the **Browser Contents** window, follow these steps:

1. Open the **Browser Contents** window, as explained in [Table 14.3](#).

**Table 14.3 Opening Browser Contents Window**

On this host...	Do this...
Windows	Select <b>View &gt; Browser Contents</b> .
Solaris	Select <b>Window &gt; Browser Contents</b> .
Linux	Select <b>Window &gt; Browser Contents</b> .

2. Select a class in the **Browser Contents** window.
3. Open a contextual menu for the selected class, as explained in [Table 14.4](#).

**Table 14.4 Opening Contextual Menu for Selected Class**

On this host...	Do this...
Windows	Right-click the selected class.
Solaris	Click and hold on the selected class.
Linux	Click and hold on the selected class.

A contextual menu like the one shown in [Figure 14.2](#) appears.

**Figure 14.2 Browser Contents Window, Contextual Menu**

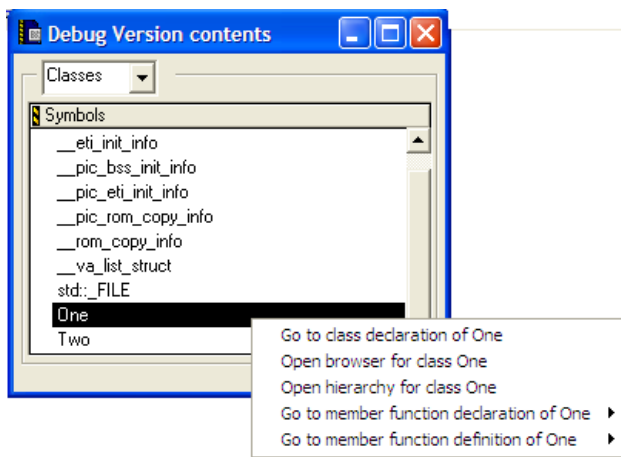

## Using Class Browser Windows

### Class Browser window

---

4. Select **Open browser for class** *classname* from the contextual menu.

The *classname* is the name of the class that you selected.

A **Class Browser** window appears.

---

## Viewing Class Data from Hierarchy Windows

To view class data from a hierarchy window, follow these steps:

1. Open a **Single-Hierarchy** or **Multi-Class Hierarchy** window:

- a. Click the **Single Class Hierarchy Window** button  in the browser toolbar,  
or

- b. Click the **Class Hierarchy** button  in the browser toolbar.

2. In the Single- or Multi-Class Hierarchy window, double-click a class name.

A **Class Browser** window appears.

---

## Expanding Browser Panes

Click the **Pane Expand** box (just above the scroll bar in the upper right-hand corner of the pane) to expand the Classes, Member Functions, Data Members, or Source panes in a **Browser** window.

1. Click the **Pane Expand** box  to expand a pane.  
This pane expands to occupy the **Browser** window.

2. Use the enlarged pane to view data.

Alternately, you can use the resize bar between the panes to enlarge each pane.

1. Rest the cursor over the resize bar.

The cursor icon changes to this: 

2. Hold down the mouse button.
3. Drag the resize bar to enlarge or shrink the pane.



## Collapsing Browser Panes

Click the **Pane Collapse** box (just above the scroll bar in the upper right-hand corner of the pane) to collapse the Classes, Member Functions, Data Members, or Source panes in a **Browser** window.

1. Click the **Pane Collapse** box  to collapse a pane.

The chosen pane collapses to its original size.

2. You can now view other panes in a Browser window.

Alternately, you can use the resize bar between the panes to collapse each pane.

1. Rest the cursor over the resize bar.

The cursor icon changes to this: 

2. Hold down the mouse button.
3. Drag the resize bar to collapse the pane.



## Classes Pane

Use the **Classes** pane to perform these tasks:

- Create a new class
- Toggle viewing of classes
- Sort classes

[Figure 14.1](#) shows the Classes pane. [Table 14.5](#) explains the items in the pane.

**Table 14.5** Classes Pane Items

Item	Icon	Explanation
New Item		Click to create a new class using the New Class Wizard.
Sort Alphabetical		Click to sort the Classes list in alphabetical order.
Sort Hierarchical		Click to sort the Classes list in hierarchical order.

## Using Class Browser Windows

### Classes Pane

---

#### Creating a New Class

Use the **New Class** wizard to specify the name, declaration, and location for a new class. Click **Finish** in any screen to apply default values to the remaining parameters and complete the process. The New Class wizard creates the files that define the class.

1. From the Classes pane, click the **New Item** button  .
2. Enter the **Name** and **Location** in the New Class window.
3. To create a more complex class, click **Next** (optional).  
Follow the on-screen directions to further define the class.
4. Click **Finish** to complete the New Class process.
5. Review the summary of the settings for new class and click **Generate**.

---

#### Showing the Classes Pane

Use the **Show Classes** button to expand the Classes pane.

1. Click the **Show Classes** button: .
2. The Classes pane appears in the **Class Browser** window.

---

#### Hiding the Classes Pane

Use the **Hide Classes** button to collapse the Classes pane.

1. Click the **Hide Classes** button: .
2. The Classes pane disappears from the **Class Browser** window.

---

#### Sorting the Classes List

Use the **Sort Alphabetical** and **Sort Hierarchical** commands to specify the sort order of classes in the Classes pane. The displayed icon always represents the alternate sort order. For example, when the Classes list appears in alphabetical order, the Sort Hierarchical icon is visible.

- Click the **Sort Alphabetical** icon  .

The IDE sorts the Classes list in alphabetical order.

- Click the **Sort Hierarchical** icon  .



The IDE sorts the Classes list in hierarchical order.

## Member Functions Pane

Use the **Member Functions** pane to perform these tasks:

- Create a new member function
- Determine the inheritance type of a member function

**Table 14.6 Member Function, Data Member Identifier Icons**

Meaning	Icon	The member is...
static		a static member
virtual		a virtual function that can be overridden, or an override of an inherited function
pure virtual or abstract		a member function that must be overridden in a subclass to create instances of that subclass

### Creating a New Member Function

Use the **New Member Function** wizard to specify the name, return type, and parameters for a new member function. Click **Finish** in any screen to apply default values to the remaining parameters and complete the process.

1. Click the **New Item** button  in the **Member Functions** pane.
2. Enter the **Member Function Declarations** in the **New Member Function** window.
3. Click **Next**.
4. Enter **Member function file locations** and **Include Files** information.
5. Click **Finish**.
6. Review the settings summary, then click **Generate**.

The IDE adds the new member function to the class declaration.

## Data Members Pane

Use the **Data Members** pane to create a new data member. This section explains how to create the data member.

Click the **New Item** button in the Data Members pane to open the New Data Member wizard. See [Table 14.6](#) for a complete list of identifier icons that appear in the Data Members pane.

---

### Creating a New Data Member

Use the **New Data Member** wizard to specify the name, type, and initializer for the new data member. Specify other options to further refine the data member. Click **Finish** in any screen to apply default values to the remaining parameters and complete the process.

1. From the **Data Members** pane, click the **New Item** button: 
2. Enter the **Data Member Declarations** in the **New Data Member** window.
3. Click **Next**.
4. Enter Data Member file locations and `#include files` information.
5. Click **Finish**.
6. Review the settings summary, then click **Generate**.

The IDE adds the new data member to the class declaration.



## Source Pane

Use the **Source** pane to view the source code that corresponds to the selected class, member function, or data member. This section explains the items in the **Source** pane.

[Figure 14.1](#) shows the Source pane. [Table 14.7](#) explains the items in the pane.

For information on editing source code, see [Editing Source Code](#).

**Table 14.7 Source Pane Items**

Item	Icon	Explanation
Open File		Click to open the current source file in a new editor window.
VCS menu		Enable a version-control system in order to activate this menu. Use this menu to select and execute a version-control command on the source file.



## Status Area

Use the status area to perform these tasks:

- Toggle viewing of the **Classes** pane
- View class declarations
- View classes according to public, private, or protected access

[Figure 14.1](#) shows the status area. [Table 14.8](#) explains items in the status area.

**Table 14.8 Status Area Items**

Item	Icon	Explanation
Show Classes Pane		Click to display the Classes pane in the Class Browser window.
Hide Classes Pane		Click to hide the Classes pane in the Class Browser window.
Class Declaration		Click to show the declaration of the current class.
Access Filter Display		Displays the access state of the current class.



## Using Class Browser Windows

*Status Area*

---

# Using Other Browser Windows

---

This chapter explains how to work with the Class Hierarchy windows in the CodeWarrior™ IDE. Use the Class Hierarchy windows to perform these tasks:

- View hierarchical browser data—the class hierarchy window shows a graphical representation of the hierarchical structure. Object-oriented languages, such as C++ and Java, allow hierarchical relationships between classes.
- Analyze inheritance structure—the class hierarchy window shows the inheritance structure of classes. This structure reveals the data-handling capabilities of a particular class.

Read this chapter to learn more about typical tasks for working with the Class Hierarchy windows.

This chapter consists of these sections:

- [Multiple-Class Hierarchy Window](#)
- [Single-Class Hierarchy Window](#)
- [Browser Contents window](#)
- [Symbols Window](#)

## Multiple-Class Hierarchy Window

Use the Multi-Class Hierarchy window to visually examine the structure of every class in the browser database. Each class name appears in a box, and lines connect boxes to indicate related classes. The left-most box is the base class, and subclasses appear to the right.

[Figure 15.1](#) shows the Multi-Class Hierarchy window. [Table 15.1](#) explains the items in the window.

## Using Other Browser Windows

### Multiple-Class Hierarchy Window

Figure 15.1 Multi-Class Hierarchy Window

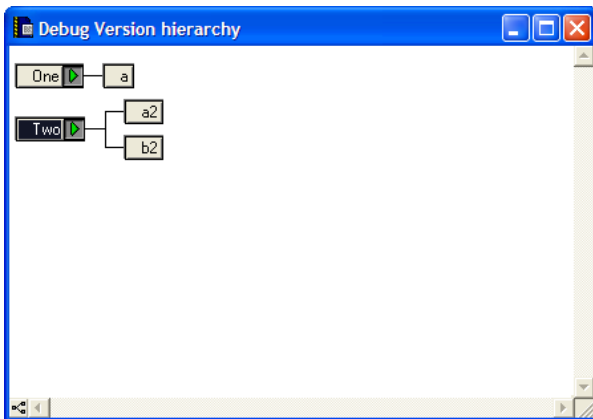

Table 15.1 Multi-Class Hierarchy Window Items

Item	Icon	Explanation
Hierarchy Control		Click to expand or collapse the subclasses displayed for a specific class.
Ancestor menu		Click and hold on class or subclass box to display a menu. Select a class from menu to display that class.
Line button		Click to toggle the lines that connect classes between diagonal and straight lines.

## Viewing Browser Data by Inheritance

Use a **Hierarchy** window to view data in graphical form and better understand class relationships. Use the expand and collapse arrows to enlarge or shrink the class views.

1. Activate the browser.
2. Update the browser database by using the **Bring Up To Date**, **Make**, **Run**, or **Debug** command.
3. Open a graphical **Hierarchy** window, as explained in [Table 15.2](#).



**Table 15.2 Opening Hierarchy Window**

On this host...	Do this...
Windows	Select <b>View &gt; Class Hierarchy</b>
Solaris	Select <b>Window &gt; Class Hierarchy</b>
Linux	Select <b>Window &gt; Class Hierarchy Window</b>

---

## Printing Class Hierarchies

To print the contents of a **Class Hierarchy** window, save an image of the window contents, then print the image file from a graphics-processing application.

The IDE saves the image in a graphics-file format based on the host platform, as shown in [Table 15.3](#).

**Table 15.3 Host Platform Graphics-File Formats**

Host	Graphics-File Format
Windows	EMF (Enhanced Metafile)
Solaris	PICT (Picture)
Linux	PICT (Picture)

1. Open the **Class Hierarchy** window.
2. Select **File > Save A Copy As**.
3. Enter name and specify location for the image file.
4. Open the image file in a graphics-processing application.
5. Print the image file.

The graphics-processing application prints the image of the class hierarchy.

---

## Changing Line Views in a Hierarchical Window

Use the **Diagonal Line** and **Straight Line** commands to change the appearance of the connecting lines between classes and subclasses in a hierarchical window display.

## Using Other Browser Windows

### Single-Class Hierarchy Window

---

- Click the **Diagonal Line** icon  .

The Hierarchical window displays diagonal lines between classes and subclasses.

- Click the **Straight Line** icon  .

The Hierarchical window displays straight lines between classes and subclasses.

## Single-Class Hierarchy Window

Use the Single-Class Hierarchy window to examine the structure of a single class in the browser database. The Single-Class Hierarchy window operates identically to the Multi-Class Hierarchy window, but restricts the display to a single class.

The Single-Class Hierarchy window contains the same components as the Multi-Class Hierarchy window.

**Figure 15.2 Single-Class Hierarchy Window**

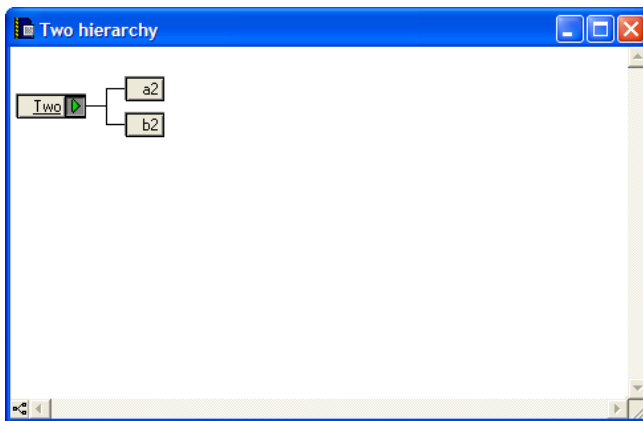

---

### Opening a Single-Class Hierarchical window

Use one of these methods to open a Single-Class Hierarchical window:

- Click the **Show Single-Class Hierarchy** icon  in the Class Browser window.
- Use the Browser Contextual menu in one of these windows:
  - Classes pane of the Class Browser window

- Browser Contents window
- Multi-Class Hierarchical window

## Browser Contents window

Use the Browser Contents window to view browser data sorted by category into an alphabetical list. This section explains how to use the Browser Contents window to view browser data.

[Figure 15.3](#) shows the Browser Contents window. [Table 15.4](#) explains the items in the window.

**Figure 15.3 Browser Contents Window**

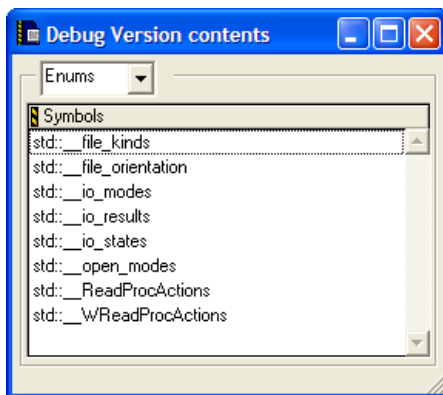

**Table 15.4 Browser Contents Window Items**

Item	Icon	Explanation
Symbols list box		Select the type of symbol to display in the Symbols list.
Symbols list		Double-click a symbol name to display the source file that defines the symbol, in a new editor window.

## Using Other Browser Windows

### Symbols Window

---

#### Viewing Browser Data by Contents

Use the **Browser Contents** window to display symbol information stored in the browser database, listed in alphabetical order. You can choose from these categories:

- classes
  - constants
  - enumerations
  - functions
  - global variables
  - macros
  - function templates
  - type definitions
1. Activate the browser.
  2. Use the **Bring Up To Date**, **Make**, **Run**, or **Debug** command to update the browser database.
  3. Open the Browser Contents window, as explained in [Table 15.5](#).

**Table 15.5 Opening Browser Contents Window**

On this host...	Do this...
Windows	Select <b>View &gt; Browser Contents</b>
Solaris	Select <b>Window &gt; Browser Contents</b>
Linux	Select <b>Window &gt; Browser Contents</b>

4. Select a category from the **Symbols** list box.  
The symbol information for the selected category appears in alphabetical order in the **Symbols** list.

## Symbols Window

The Symbols window displays information from project browser databases. With the browser enabled, the IDE generates a browser database for a project during the build process.

The Symbols window displays symbols that have multiple definitions in the browser database. For example, the window displays information about multiple versions of overridden functions in object-oriented code.

[Figure 15.4](#) shows the Symbols window. [Table 15.5](#) explains the items in the window.

**Figure 15.4 Symbols Window**

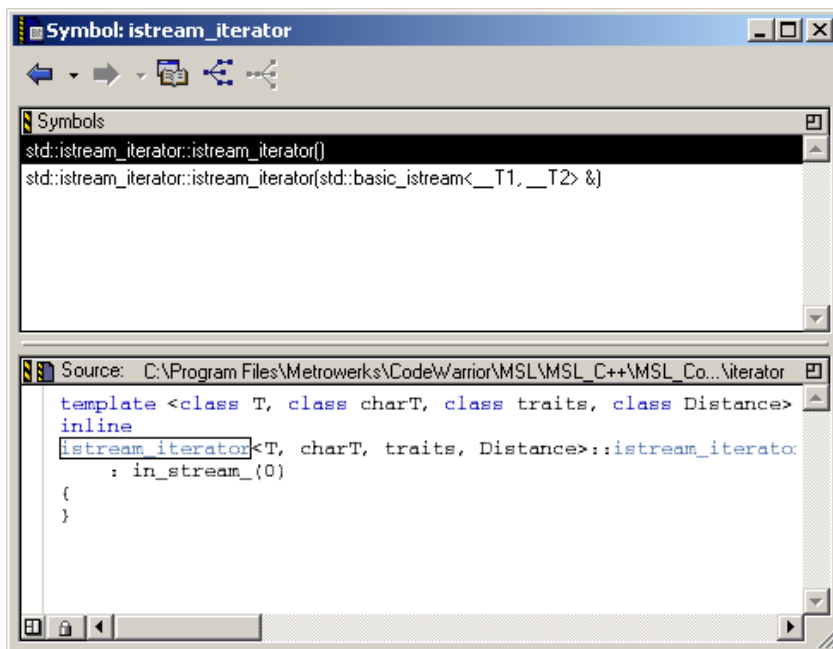

**Table 15.6 Symbols Window Items**

Item	Explanation
<a href="#">Symbols toolbar</a>	Provides one-click access to common browser commands and class-filtering commands.
<a href="#">Symbols pane</a>	Displays a list of all symbols with multiple declarations.
<a href="#">Source pane</a>	Displays the source code for the currently selected item.

## Using Other Browser Windows

### Symbols Window

---

## Opening the Symbols Window

Use the **Symbols** window to list all implementations, whether overridden or not, of any symbol that has multiple definitions. You can access the Symbols window by using a contextual menu.

1. Open a contextual menu, as explained in [Table 15.7](#).

**Table 15.7** Opening Symbols Window

On this host...	Do this...
Windows	Right-click the symbol name.
Solaris	Click and hold on the symbol name.
Linux	Click and hold on the symbol name.

2. Select **Find all implementations of** from the contextual menu that appears.
3. The Symbols window opens.

## Symbols toolbar

Most of the Symbol toolbar items are identical to those in the [Class Browser Window](#).

## Symbols pane

The **Symbols** pane lists symbols with multiple definitions in the browser database. Select a symbol from the list to view its definition in the **Source** pane.

## Source pane

The **Source** pane used in the Symbols window is identical to the one used by the [Class Browser Window](#). See [Source pane](#) for more details.

# Using Browser Wizards

---

When you create a new class, member function, or data member in the IDE, you use browser wizards. These wizards provide the steps to help you complete the process.

This chapter provides information on these wizards:

- [New Class Wizard](#)
- [The New Member Function Wizard](#)
- [The New Data Member Wizard](#)

---

**NOTE** Most wizard pages contain default settings. To accept all current settings in the wizard, click **Finish** in any screen. The wizard displays a summary of all current settings for the new project. Click **Generate** to accept the current settings and create the new item, or click **Cancel** to return to the wizard to modify settings.

---

## New Class Wizard

[Figure 16.1](#) shows the **New Class** wizard Name and Location page. Use this page to specify the name, declaration, and location for a new class. Click **Finish** in any screen to apply default values to remaining parameters to complete the process. The New Class wizard creates the files that define the class.

## Using Browser Wizards

### New Class Wizard

Figure 16.1 New Class Wizard Name, Location

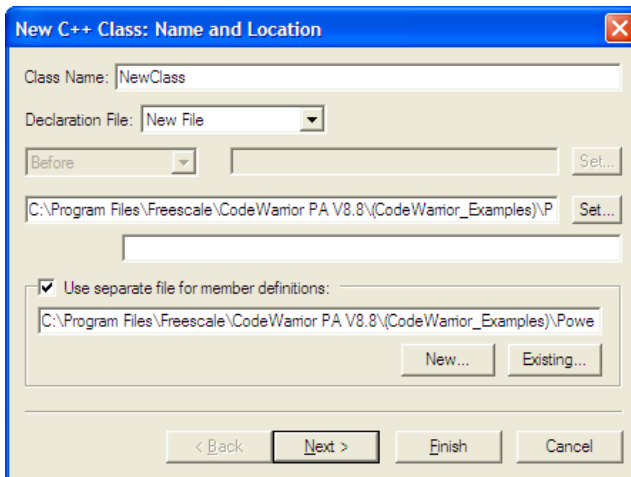

## Using the New Class Wizard

To use the New Class Wizard, follow these steps:

1. Open the **Class Browser** window, as [Table 16.1](#) explains.

Table 16.1 Opening Class Browser Window

On this host...	Do this...
Windows	Select <b>View &gt; Class Browser</b>
Solaris	Select <b>Window &gt; New Class Browser</b>
Linux	Select <b>Window &gt; New Class Browser</b>

2. Select **Browser > New Class**, or click the New Item icon  in the **Classes** pane of the **Class Browser** window.

**NOTE** The Browser menu appears only if the **Class Browser** window is opened.

3. In the **New C++ Class** wizard, enter Name and Location information:



- a. **Class Name**—Enter a name for the class in this field.
- b. **Declaration File**—This list box lets you specify whether the file is a **New File**, which is a new declaration file, or **Relative to class**, which is a declaration that depends on an existing file in the project.

If you select the **New File** option, type in the path where you want to save the file. Alternatively, click **Set** next to the field to choose the path in which to save the file.

If you select the **Relative to class** option, select **Before** or **After** to establish the order of the new class in relation to existing classes. In the field next to the Before and After selection, type the name of the class you want to relate to the new class. Alternatively, click **Set** next to this field, type the name of a class in the window that opens, and then click **Select**.

**NOTE** If you want to use a separate file to define the members of the new class, type the path to the separate file in the field below the **Use separate file for member definitions** checkbox. Alternatively, click **Existing** to use a standard dialog box to select the file. To create a new, separate file, click **New** and save the new file to a location on your hard disk.

4. Click **Next**. The **Base Classes and Methods** page ([Figure 16.2](#)) appears.

**Figure 16.2** New Class Wizard Base Class, Methods

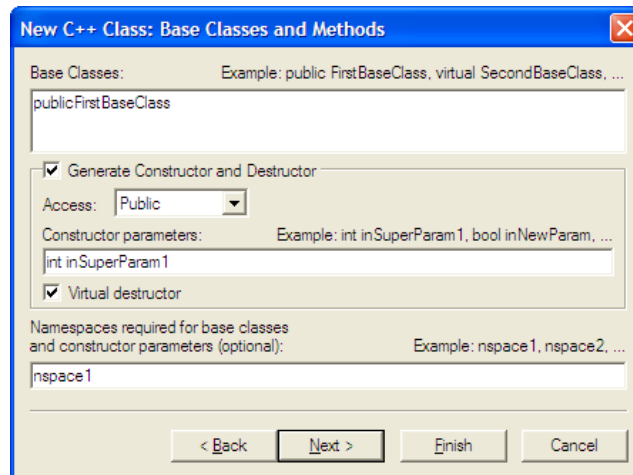

5. Enter Base Classes and Methods information.  
Enter a list of base classes for the new class:

## Using Browser Wizards

### New Class Wizard

- a. **Access**—From this list box, select an access type, **Public**, **Protected**, or **Private**, for the constructor and destructor.
  - b. **Constructor parameters**—Enter a list of parameters for the constructor.
  - c. **Virtual destructor**—Check this checkbox to create a virtual destructor for the new class.
  - d. As an option, you can enter the required namespaces for the base classes and the constructor parameters in the field labeled **Namespaces required for the base classes and constructor parameters**.
- Or,
- If needed, you can specify the base classes and constructor parameters.
6. Click **Next**. The Include Files page ([Figure 16.3](#)) appears.

**Figure 16.3** New Class Wizard Include Files

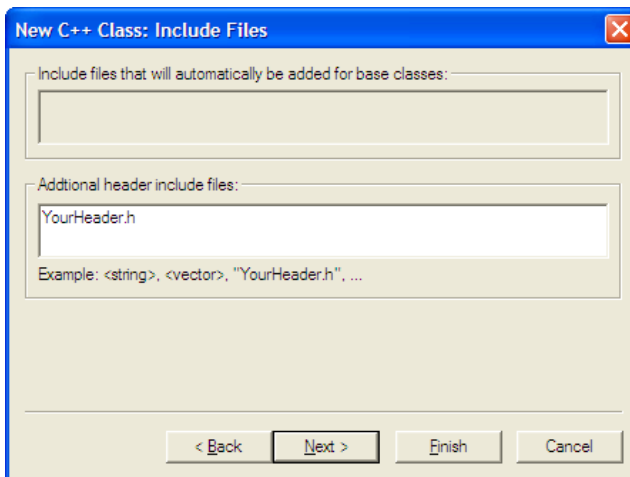

7. Enter **Include Files** information.
 

Specify additional header `#include` files for the new class:

  - a. **Include files that will automatically be added for base classes**—This field shows you a list of `#include` files that the IDE automatically adds to find the base classes.
  - b. **Additional header include files**—Enter a list of other include files for the new class in addition to those in the previous field. Separate each file in the list with a comma.
8. Click **Next**. The **Targets** page ([Figure 16.4](#)) appears.

Figure 16.4 New Class Wizard Targets

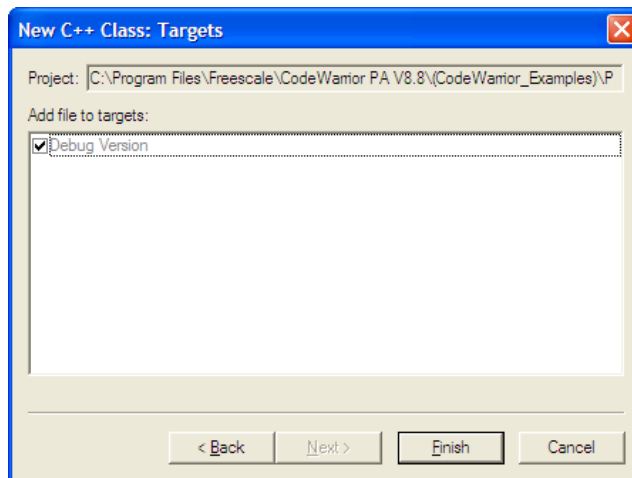

9. Enter **Targets** information:  
Check the checkbox next to the build target's name in the list to add the class files to a specific build target.
10. Click **Finish**.  
Review the settings summary.
11. Click **Generate**.

## The New Member Function Wizard

[Figure 16.5](#) shows the **New Member Function** wizard Member Function Declaration page. Use this page to specify the name, return type, and parameters for a new member function. Enter additional information in the wizard fields to refine the function definition.

## Using Browser Wizards

### The New Member Function Wizard

Figure 16.5 New Member Function Wizard

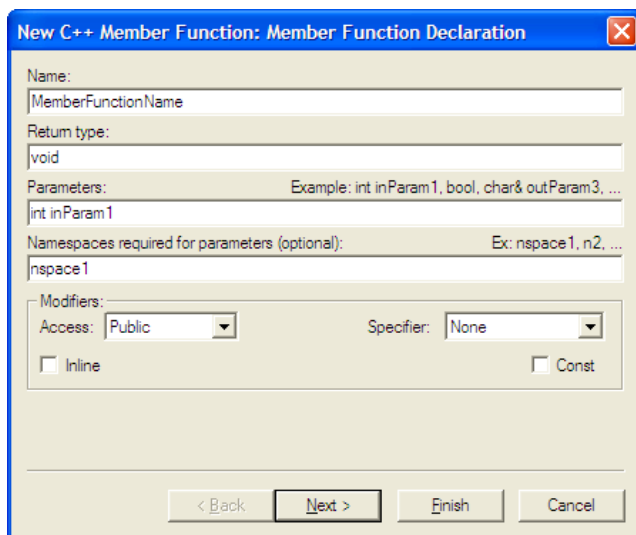

## Using the New Member Function Wizard

To use the New Member Function wizard, follow these steps:

1. Open the **Class Browser** window, as [Table 16.2](#) explains.

Table 16.2 Opening Class Browser Window

On this host...	Do this...
Windows	Select <b>View &gt; Class Browser</b>
Solaris	Select <b>Window &gt; New Class Browser</b>
Linux	Select <b>Window &gt; New Class Browser</b>

2. Select **Browser > New Member Function**, or click the New Item icon  in the **Member Functions** pane of the **Class Browser** window.

**NOTE** The Browser menu appears only if the **Class Browser** window is opened.

3. In the **New C++ Member Function** window, enter the Member Function Declaration.

- a. **Name**—Type a name for the member function.
  - b. **Return Type**—Enter an appropriate function return type.
  - c. **Parameters**—Type a list of function parameters.
  - d. **Namespaces required for parameters (optional)**—Type a list of namespaces required for parameters.
4. Click **Next**. The **File Locations** page ([Figure 16.6](#)) appears.

**Figure 16.6 New Member Function Wizard File Locations**

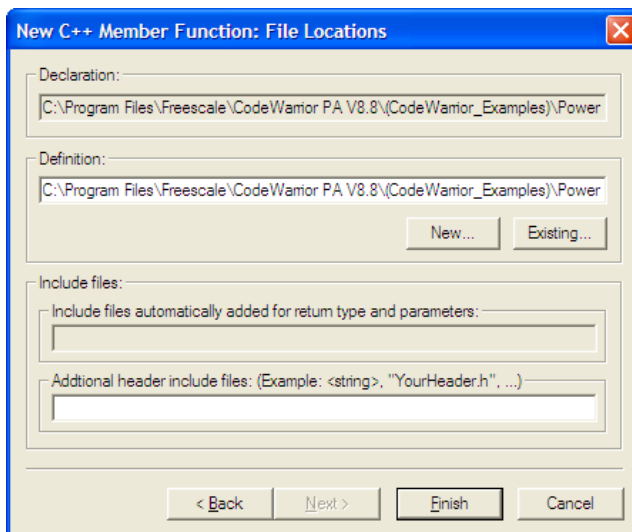

5. Enter Member Function File Locations and Include Files information.
6. Click **Finish**.
7. Review settings summary, then click **Generate**.

## The New Data Member Wizard

[Figure 16.7](#) shows the **New Data Member** wizard Declaration page. Use this page to define the new data-member declaration, and to specify new data member file locations. The wizard offers additional options to further define the function.

## Using Browser Wizards

### The New Data Member Wizard

Figure 16.7 New Data Member wizard

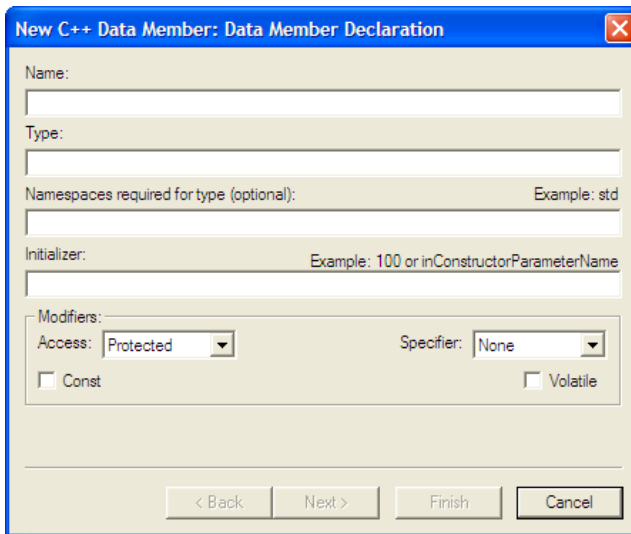

## Using the New Data Member Wizard

To use the New Data Member wizard, follow these steps:

1. Open the **Class Browser** window, as [Table 16.3](#) explains.

Table 16.3 Opening Class Browser Window

On this host...	Do this...
Windows	Select <b>View &gt; Class Browser</b>
Solaris	Select <b>Window &gt; New Class Browser</b>
Linux	Select <b>Window &gt; New Class Browser</b>

2. Select **Browser > New Data Member**, or click the New Item icon  in the **Data Members** pane of the **Class Browser** window.

**NOTE** The Browser menu appears only if the **Class Browser** window is opened.

3. In the **New C++ Data Member** window, enter the Name, Type, Namespaces required for type (optional), Initializer, and Modifiers.
  - a. **Name**—Type a name for the data member in this field.
  - b. **Type**—Enter an appropriate data-member type in this field.
  - c. **Namespaces required for type (optional)**—(Optional) Enter a list of namespaces required for the type in the **Type** field. A sample namespace is `std`.
  - d. **Initializer**—(Optional) Enter an initial value for the data member in this field. Sample initializers are `100` and `inConstructorParameterName`.
  - e. **Modifiers**—Select the access level and type for the new data member.
4. Click **Next**. The **File Locations** page appears.
5. Specify Data Member File Locations.

This section lets you specify file locations associated with the new member functions, including these fields: **Declaration**, **Definition**, **Include file automatically added for member type**, and **Additional header include files**.

- a. **Declaration**—This field shows you the data member's declaration file location.
  - b. **Definition**—This field is not available in this wizard.
  - c. **Include file automatically added for member type**—This field indicates whether an include file will be automatically added for the data-member type.
  - d. **Additional header include files**—Enter in this field a list of other include files for the new data member, in addition to the file listed in the previous field. Example files are `<string>` and `YourHeader.h`.
6. Click **Finish**.
  7. Review settings summary, then click **Generate**.



## Using Browser Wizards

*The New Data Member Wizard*

---



# Debugger

---

This section contains these chapters:

- [Working with the Debugger](#)
- [Manipulating Program Execution](#)
- [Working with Variables](#)
- [Working with Memory](#)
- [Working with Debugger Data](#)
- [Working with Hardware Tools](#)
- [Profiler](#)



# Working with the Debugger

---

This chapter explains how to work with the debugger in the CodeWarrior™ IDE to control program execution. The main component of the debugger is the Thread window, which shows these items:

- Common debugging controls—step, kill, start, and stop program execution
- Variable information—see the variables in the executing code, their values, and their addresses
- Source code—see the source code under debugger control

This chapter consists of these sections:

- [About the Debugger](#)
- [About Symbolics Files](#)
- [Thread Window](#)
- [Common Debugging Actions](#)
- [Symbol Hint](#)
- [Contextual Menus](#)
- [Multi-Core Debugging](#)
- [External Builds Support](#)

## About the Debugger

A *debugger* controls program execution and shows the internal operation of a computer program. Use the debugger to find problems while the program executes. Also use the debugger to observe how a program uses memory to complete tasks.

The CodeWarrior debugger provides these levels of control over a computer program:

- Execution of one statement at a time
- Suspension of execution after reaching a specific point in the program
- Suspension of execution after changing a specified memory value

After the debugger suspends program execution, use various windows to perform these tasks:

- View the function-call chain

## Working with the Debugger

### About Symbolics Files

---

- Manipulate variable values
- View register values in the computer processor

## About Symbolics Files

A *symbolics file* contains debugging information that the IDE generates for a computer program. The debugger uses this information to control program execution. For example, the debugger uses the symbolics file to find the source code that corresponds to the executing object code of the computer program.

Symbolics files contain this information:

- Routine names
- Variables names
- Variable locations in source code
- Variable locations in object code

The IDE supports several types of symbolics files. Some programs generate separate symbolic files, while others do not. For example, when you use CodeView on Windows, the IDE places the symbolics file inside the generated binary file.

## Thread Window

The debugger suspends execution of processes in a computer program. The Thread window displays information about a suspended process during a debug session.

Use the Thread window to perform these tasks:

- View the call chain for a routine
- View routine variables, both local and global
- View a routine in terms of its source code, assembly code, or a mix of both types of code

[Figure 17.1](#) shows the Thread window. [Table 17.1](#) explains the items in the window.

Figure 17.1 Thread Window

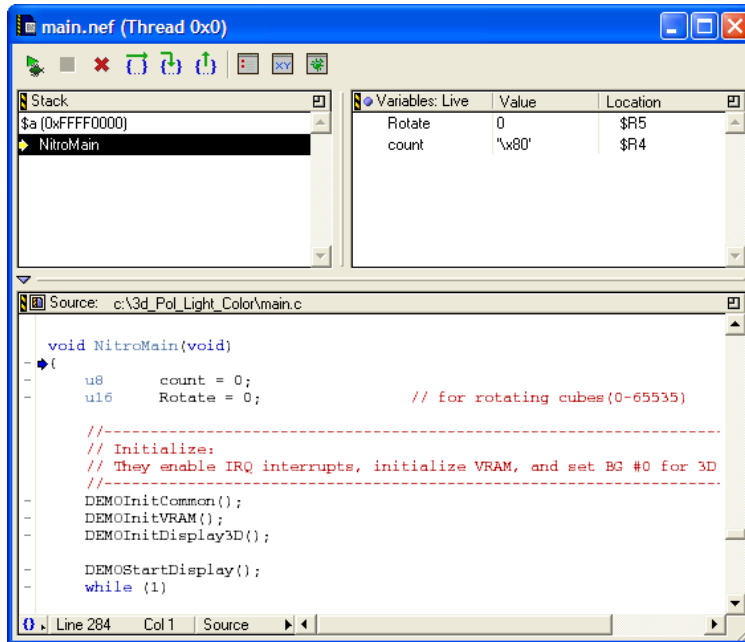









Table 17.1 Thread Window Items

Item	Icon	Explanation
Debug / Run / Resume button		Click to perform these tasks: <ul style="list-style-type: none"> <li>Continue execution up to the next breakpoint, watchpoint, or eventpoint</li> <li>Run the program until it exits</li> <li>Continue execution of a currently stopped program</li> </ul>
Break / Stop button		Click to stop (pause) program execution.
Kill Thread button		Click to terminate program execution and close the Thread window.

## Working with the Debugger

### Thread Window

**Table 17.1 Thread Window Items (continued)**

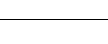
Item	Icon	Explanation
Step Over button		Click to execute the current line, including any routines, and proceed to the next statement.
Step Into button		Click to execute the current line, following execution inside a routine.
Step Out button		Click to continue execution to the end of the current routine, then follow execution to the routine's caller.
Breakpoints button		Click to open the <b>Breakpoints</b> window.
Expressions button		Click to open the <b>Expressions</b> window.
Symbolics button		Click to open the <b>Symbolics</b> window.
Pane Expand box		Click to enlarge the pane to fill the window.
Pane Collapse box		Click to reduce an expanded pane to its original size.
Pane resize bar		Drag to resize the panes on either side of the bar.
Stack pane		Shows the current routine calling chain, with the most current routine name at the bottom
Variables pane		Shows local and global variables that the current routine uses.



**Table 17.1 Thread Window Items (continued)**

Item	Icon	Explanation
Variables Pane Listing button		Click this icon to switch among these display states: <ul style="list-style-type: none"> <li>• Live—shows only the local variables that are in scope for the current location.</li> <li>• All—shows all local and global variables in the code</li> <li>• Auto—shows only the local variables of the routine pointed to by the current-statement arrow</li> <li>• None—shows no variables. Use this display state to improve stepping performance for slow remote connections</li> </ul>
Source pane disclosure triangle		Click to show or hide the Source pane.
Source pane		Shows the executing source code. This pane operates the same way as an editor window, however, you cannot edit the contents of the pane or use pane-splitter controls.
Source File button		Click to edit the contents of the Source pane in an editor window.
Current-statement arrow		Points to statement that debugger will execute next.
Dash	—	Appears to left of each line at which you can set a breakpoint or eventpoint. Click the dash to set a breakpoint on that line.
Functions list box		Click to show a list of functions declared in the file. Select a function to highlight it in the Source pane.

## Working with the Debugger

### Common Debugging Actions

**Table 17.1 Thread Window Items (continued)**

Item	Icon	Explanation
Line and Column button		Shows the current line and column number of the text-insertion cursor. Click to specify a line to show in the Source pane.
Source list box		Click to specify how to display source code in the Source pane: <ul style="list-style-type: none"> <li>• Source—programming-language statements appear exclusively in the pane</li> <li>• Assembler—assembly-language instructions appear exclusively in the pane</li> <li>• Mixed—each programming-language statement shows its corresponding assembly-language instructions</li> </ul>

## Common Debugging Actions

This section explains how to perform common debugging actions that correct source-code errors, control program execution, and observe memory behavior:

- Start the debugger
- Step into, out of, or over routines
- Stop, resume, or kill program execution
- Run the program
- Restart the debugger

### Starting the Debugger

Use the **Debug** command to begin a debugging session. The debugger takes control of program execution, starting at the main entry point of the program.



Select **Project > Debug** or click the Debug button (shown at left) to start the debugger.

After you start the debugging session, the IDE opens a new Thread window.



**NOTE** Some projects require additional configuration before the debugging session can begin. The IDE might prompt you for permission to perform this configuration automatically.

---

---

## Stepping Into a Routine

Use the **Step Into** command to execute one source-code statement at a time and follow execution into a routine call.



Select **Debug > Step Into** or click the Step Into button to step into a routine.

After the debugger executes the source-code statement, the current-statement arrow moves to the next statement determined by these rules:

- If the executed statement did not call a routine, the current-statement arrow moves to the next statement in the source code.
- If the executed statement called a routine, the current-statement arrow moves to the first statement in the called routine.
- If the executed statement is the last statement in a called routine, the current-statement arrow moves to the statement that follows the calling routine.

---

## Stepping Out of a Routine

Use the **Step Out** command to execute the rest of the current routine and stop program execution after the routine returns to its caller. This command causes execution to return up the calling chain.



Select **Debug > Step Out** or click the Step Out button to step out of a routine.

The current routine executes and returns to its caller, then program execution stops.

---

## Stepping Over a Routine

Use the **Step Over** command to execute the current statement and advance to the next statement in the source code. If the current statement is a routine call, program execution continues until reaching one of these points:

- the end of the called routine
- a breakpoint
- a watchpoint

## Working with the Debugger

### Common Debugging Actions

---

- an eventpoint that stops execution



Select **Debug > Step Over** or click the Step Over button to step over a routine.

The current statement or routine executes, then program execution stops.

---

## Stopping Program Execution

Use the **Break** or **Stop** command to suspend program execution during a debugging session.

- Select **Debug > Break**, **Debug > Stop**, or click the Stop button to stop program execution.

The operating system surrenders control to the debugger, which stops program execution.

---

## Resuming Program Execution

Use the **Resume** command to continue executing a suspended debugging session. If the debugging session is already active, use this command to switch view from the Thread window to the executing program.



Select **Project > Resume** or click the Run button to resume program execution.

The suspended session resumes, or the view changes to the running program.

---

**NOTE** The Resume command appears only for those platforms that support it. If your platform does not support this command, you must stop the current debugging session and start a new session.

---

## Killing Program Execution

Use the **Kill** command to completely terminate program execution and end the debugging session. This behavior differs from stopping a program, as stopping temporarily suspends execution.

- ✘ Select **Debug > Kill** or click the Kill button to kill program execution.

The debugger terminates program execution and ends the debugging session.

---

## Running a Program

Use the **Run** command to execute a program normally, without debugger control.

---

- ▶ Select **Project > Run** or click the Run button to begin program execution.  
The debugger does not control program execution as the program runs.

## Restarting the Debugger

Use the **Restart** command after stopping program execution. The debugger goes back to the beginning of the program and begins execution again. This behavior is equivalent to killing execution, then starting a new debugging session.

Select **Debug > Restart** to restart the debugger.

## Symbol Hint

The symbol hint shows information about variable values. This information appears automatically while the debugger is active. [Figure 17.2](#) shows such a symbol hint.

Select the [Show variable values in source code](#) option in the [Display Settings](#) preference panel to use the symbol hint.

Figure 17.2 Symbol Hint

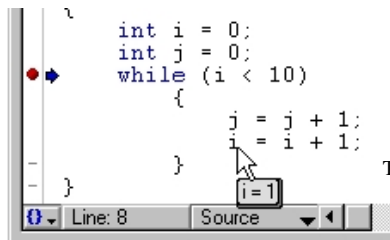

The symbol hint shows the current variable

## toggling the Symbol Hint

Turn on the symbol hint to view information about program variables in source views.

1. Select **Edit > Preferences**.  
The IDE Preferences window appears.
2. Select **Debugger > Display Settings** in the IDE Preference Panels list.
3. Check or clear the **Show variable values in source code** checkbox.  
Check the checkbox to use the symbol hint. Clear the checkbox to stop using the symbol hint.
4. Click **Apply** or **Save** to confirm your changes to the preference panel.

## Working with the Debugger

### Contextual Menus

---

5. Close the IDE Preferences window.

---

### Using the Symbol Hint

During a debugging session, use the symbol hint to view information about program variables.

To use the symbol hint, rest the cursor over a variable in a source view. After a brief pause, the symbol hint appears and shows the current variable value.

## Contextual Menus

Contextual menus provide shortcuts to frequently used menu commands. The available menu commands change, based on the context of the selected item.

Sample uses of contextual menus for debugging include:

- changing the format of variables displayed in variable panes
- manipulating breakpoints and the program counter in source panes
- viewing memory in separate windows

---

**TIP** Experiment using the contextual menu in various IDE windows to discover additional features.

---

[Figure 17.3](#) shows a sample contextual menu in a source view.

Figure 17.3 Contextual menus

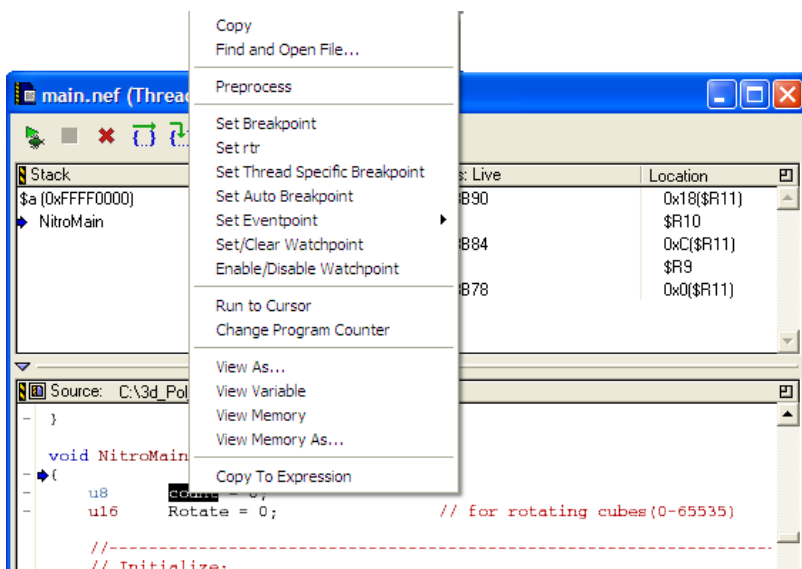

## Using Contextual Menus

Use contextual menus to apply context-specific commands to selected items. Right-click, Control-click, or click and hold on an item to open a contextual menu for that item. The contextual menu appears, displaying menu commands applicable to the selected item.

## Multi-Core Debugging

The IDE allows simultaneous debugging of multiple projects. This feature provides multi-core debugging capability for some embedded processors. By configuring each project to operate on a single core, the IDE can debug multiple cores by debugging multiple projects.

Configuring multi-core debugging involves these tasks:

- configuring specific target settings for each project
- for some cores, specifying a configuration file for initializing multi-core debugging

For more information, see the *Targeting* documentation.

## Data Viewer Plug-ins

Data Viewers (also sometimes called Data Visualization tools) are plug-ins that include an user interface to show a custom view of data. These plug-ins are often platform specific. Data editors are data viewers that also let you modify and write data.

The IDE will keep a registry of plug-ins that can view particular types. The plug-ins will register themselves with the IDE and indicate which formats and platforms they support. When a variable or memory address is selected, you can choose the plug-in from the Data menu.

A Data Viewer plug-in may also designed without a custom user interface. This type of viewer would override the built in debugger methods of showing a variable value as text and parsing an edited value back into variable data.

## External Builds Support

The IDE performs these tasks on external makefiles:

- Build
- Debug
- File Management in Project Manager window
- Source Browsing
- Error Lookup

The IDE can use build information from an external makefile to build an application. The IDE does this by using a linker plug-in that acts as a command line interpreter. The linker plug-in executes commands that are in the makefile. The linker plug-in can pass the name of the executable file that results from the build to the debugger.

The linker plug-in will provide a preference panel named External Build that is used to configure a target. The preference panel provides text fields for you to configure the command line for the target (which will enable building), specify the working directory and the output file used to launch a debugging session, and the debug platform.

The linker plug-in is generic so that it can be used regardless of the target CPU and OS. The list of available debugger preference panels will be updated by the IDE when you select the debug platform.

[Figure 17.4](#) shows the External Build Target panel.

Figure 17.4 External Build Target Panel

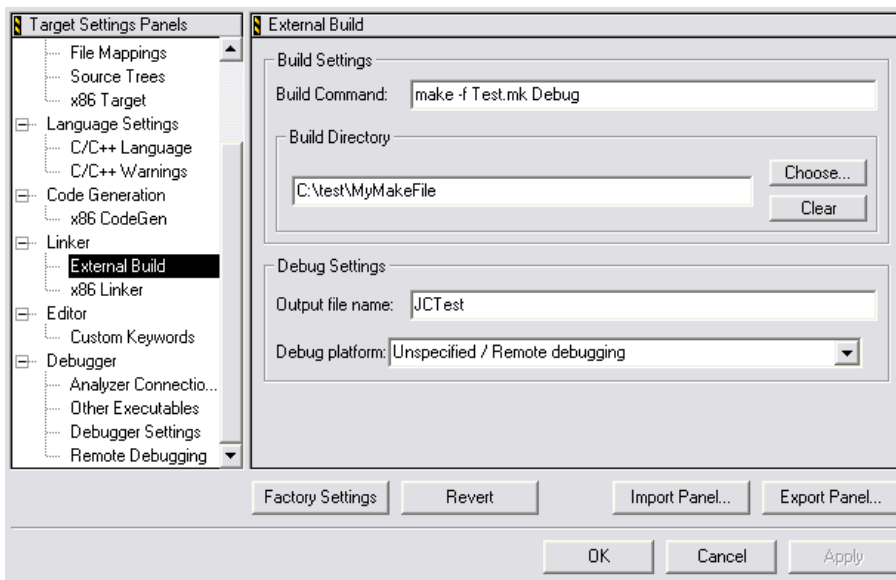

**NOTE** External Build panel shows up in the Target Settings window only for the projects that are created using [External Build Wizard](#).

Use this panel to enter the following information:

- Build command line to be executed in the build step  
The command will be sent to the OS shell and will contain all parameters and/or switches that are necessary for proper building of the make file.
- Build directory in which command line will be executed.
- Output file name—Executable to be launched in the debug step. The file will be relative to the output directory specified in the Target Settings preference panel.
- Debug platform—The debugger platform represents the combination of OS and CPU that your build is targeting. “Unspecified/Remote debugging” is the default, which indicates you have not specified a debug platform. In most cases, not specifying a platform will result in not being able to debug. However, some platforms may allow debugging if no additional debugger preference panel is used. If only one platform entry exists with the “Unspecified” option, then it will become the default entry.

After the IDE converts the makefile into a CodeWarrior project, source files can be added in the project manager window. Files that appear in the project manager will be parsed by

## Working with the Debugger

### External Builds Support

---

the language parser and will supply Source Browsing information, such as code completion.

When a build step is initiated, the linker plug-in will gather output after the command line begins executing. Output is directed to the IDE and displayed in a read-only Build Output Window. A build output window, such as [Figure 17.5](#), is displayed for each target. The build output window can be displayed manually by selecting the menu command **View > Build Output** (Windows) or **Window > Build Output** (Linux/Solaris). This command is enabled for targets that use the external build linker.

**Figure 17.5 Build Output Window**

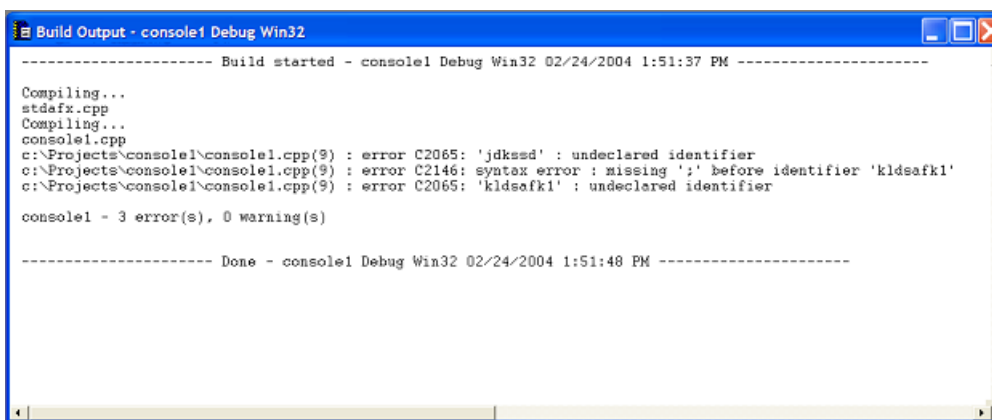

```
Build Output - console1 Debug Win32
----- Build started - console1 Debug Win32 02/24/2004 1:51:37 PM -----
Compiling...
stdafx.cpp
Compiling...
console1.cpp
c:\Projects\console1\console1.cpp(9) : error C2065: 'jdkssd' : undeclared identifier
c:\Projects\console1\console1.cpp(9) : error C2146: syntax error : missing ';' before identifier 'kldsafk1'
c:\Projects\console1\console1.cpp(9) : error C2065: 'kldsafk1' : undeclared identifier

console1 - 3 error(s), 0 warning(s)

----- Done - console1 Debug Win32 02/24/2004 1:51:48 PM -----
```

If multiple build steps are performed on the same target, the output from each build step will be appended to the build output window. Each block of output will be separated by “---Build started---” and “---Done---” tags.

The build output window will allow users to navigate directly to the location of a compilation error. Double-click a line that contains an error message or press Enter when the cursor is in the line. If the IDE determines that a valid error message exists on the selected line, the source file is opened to the line on which the error occurred.

Click the right mouse button in the build output window to display a context menu.

- The Copy command will copy selected text to the clipboard. If no text is selected then the line that contains the cursor will be copied.
- The Clear All command will clear contents of output window.
- The Go To Error command will navigate to the error location. This is identical to double-clicking.



## External Build Wizard

[Figure 17.6](#) and [Figure 17.7](#) show the two pages of the External Build wizard. This wizard prompts you for project-creation information based on external make files. The wizard collects data about the make file and creates a CodeWarrior project with a single target. The target is then configured to build the user-specified make file.

The wizard can be launched by selecting **File > New...** and selecting **External Build Wizard** from the New dialog box. The New dialog box will collect the name and location of the project before launching the wizard.

**Figure 17.6 External Build Wizard Page 1**

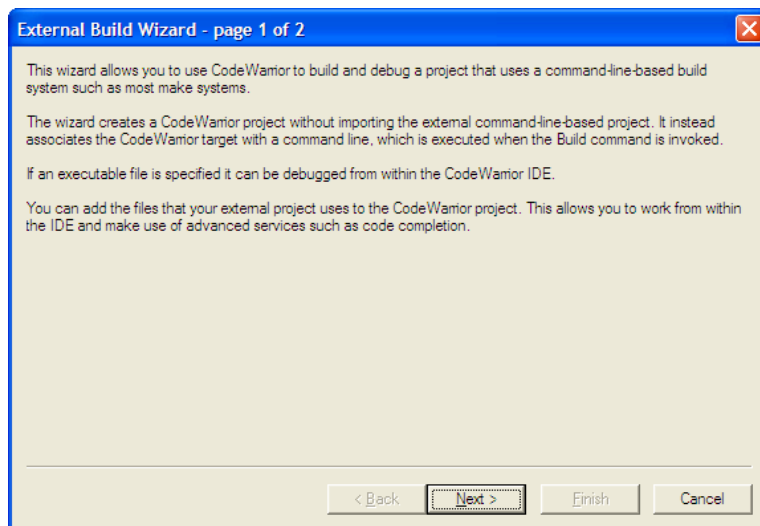

## Working with the Debugger

### External Builds Support

---

Figure 17.7 External Build Wizard Page 2

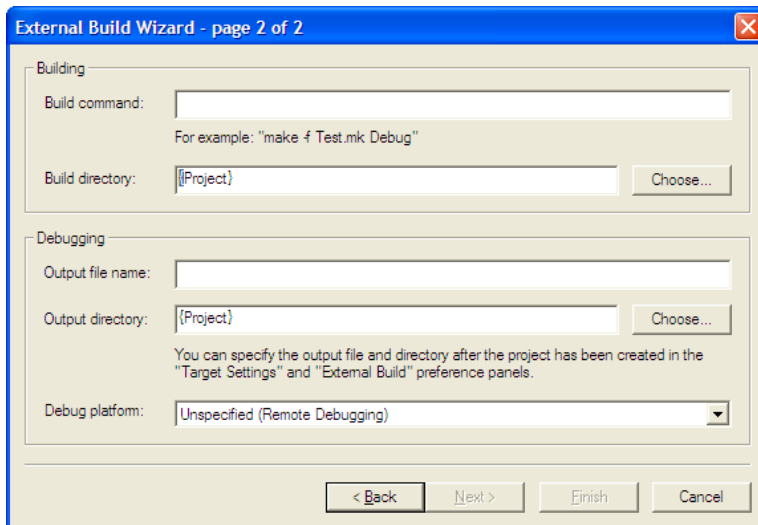

The screenshot shows a dialog box titled "External Build Wizard - page 2 of 2". It is divided into two main sections: "Building" and "Debugging".

**Building section:**

- Build command:** A text input field with a placeholder example: "make f Test.mk Debug".
- Build directory:** A text input field containing "{Project}" and a "Choose..." button to the right.

**Debugging section:**

- Output file name:** A text input field.
- Output directory:** A text input field containing "{Project}" and a "Choose..." button to the right.
- Help text:** "You can specify the output file and directory after the project has been created in the 'Target Settings' and 'External Build' preference panels."
- Debug platform:** A dropdown menu currently set to "Unspecified (Remote Debugging)".

**Navigation buttons:** At the bottom, there are four buttons: "< Back", "Next >", "Finish", and "Cancel".

If the Output filename entry is blank, you can still finish the wizard, but no debugging can be done until you enter an output file in the External Build target panel. You can also finish the wizard if the Debug platform choice is set to "Unspecified". Although, no debugging can be performed until you specify a debug platform in the External Build target panel.

Completing the wizard will generate a new CodeWarrior IDE project and configure it for use with the external make file. The wizard will automate these tasks:

- Create project with single target named "External makefile"
- Set Linker to external make file linker
- Define settings in External Build target panel based on data collected from wizard

# Manipulating Program Execution

This chapter explains how to use breakpoints, watchpoints, and eventpoints to manipulate execution of your program in the CodeWarrior™ IDE:

- Breakpoints—halt program execution on a line of source code that you specify. You can set a breakpoint that always halts program execution, or you can set a breakpoint that halts program execution if a condition that you specify is true.
- Eventpoints—perform a task during program execution on a line of source code that you specify. Eventpoints can play sounds, run scripts, log data, and perform other operations.
- Watchpoints—halt program execution after a location in memory is accessed
- Special breakpoints—these internal breakpoints halt program execution in special cases, such as halting program execution at the `main()` function or for a C++ exception.

After you set these items in your source code, you start a debugging session to use them. As program execution arrives at each of these items, the debugger can halt execution, perform a task, or update data.

This chapter consists of these sections:

- [Breakpoints](#)
- [Eventpoints](#)
- [Watchpoints](#)
- [Special Breakpoints](#)

## Breakpoints

You use *breakpoints* to halt program execution on a specific line of source code. After program execution halts at a breakpoint, you can examine the program's current state, check register and variable values, change values, and alter the flow of normal program execution. Setting breakpoints helps you debug your program and verify its efficiency.

You can use these types of breakpoints:

- regular breakpoints—halt program execution

## Manipulating Program Execution

### Breakpoints



---

- conditional breakpoints—halt program execution after meeting a condition that you specify
- temporary breakpoints—halt program execution and then remove the breakpoint that caused the halt

You can also create breakpoint templates to simplify the process of setting complex breakpoints. A *breakpoint template* has all the properties of a breakpoint, except that it has no location in source code. After you define a breakpoint template, you can use the template as the basis for each breakpoint you set in your source code.

Breakpoints have *enabled* and *disabled* states. [Table 18.1](#) explains these states.

**Table 18.1 Breakpoint States**

State	Icon	Explanation
Enabled		Indicates that the breakpoint is currently enabled. The debugger halts program execution at an enabled breakpoint. Click the Enabled icon, in the <a href="#">Breakpoints Window</a> , to disable the breakpoint.
Disabled		Indicates that the breakpoint is currently disabled. The debugger does not halt program execution at a disabled breakpoint. Click the Disabled icon, in the <a href="#">Breakpoints Window</a> , to enable the breakpoint.

## Breakpoints Window

Use the **Breakpoints** window to set breakpoints. [Figure 18.1](#) shows this window. [Table 18.2](#) explains items in the window.

You can change the sort order of items in the Breakpoints window by clicking the column titles. Click the sort order button above the vertical scroll bar to toggle between ascending and descending sort order.

**Figure 18.1 Breakpoints Window**

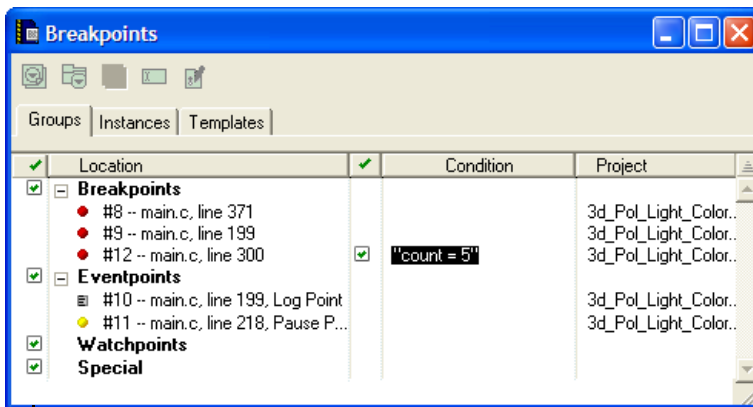

Click an icon in this column to disable or enable a group

Click an icon in this column to disable or enable the Condition associated with the item.

Shows projects that the item affects.





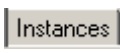

**Table 18.2 Breakpoints Window Items**

Item	Icon	Explanation
Create Breakpoint Template		Click to create a new breakpoint template in the <b>Templates</b> page.  You can create complex breakpoints based on properties you define in the breakpoint template.
Create Breakpoint Group		Click to create a new group in the <b>Groups</b> page of the <b>Breakpoints</b> window.  Clicking this button is equivalent to selecting <b>Breakpoints &gt; Create Breakpoint Group</b> .



## Manipulating Program Execution

### Breakpoints

**Table 18.2 Breakpoints Window Items (continued)**

Item	Icon	Explanation
Set Default Breakpoint Template		<p>Click to designate the selected item in the <b>Templates</b> page as the default breakpoint template. The debugger uses this template as the basis for creating new breakpoints.</p> <p>Clicking this button is equivalent to selecting <b>Breakpoints &gt; Set Default Breakpoint Template</b> with the Breakpoints window &gt; Templates page frontmost.</p>
Rename Breakpoint		<p>Click to rename the selected item in the <b>Breakpoints</b> window.</p> <p>Clicking this button is equivalent to selecting <b>Breakpoints &gt; Rename Breakpoint</b> with the Breakpoints window frontmost.</p> <p><b>Note:</b> You can also rename a breakpoint by selecting the breakpoint and pressing <b>Enter</b> or <b>Return</b> key</p>
Breakpoint Properties		<p>Click to view more information about the selected breakpoint, such as name, associated condition, and number of hits during execution.</p> <p>Clicking this button is equivalent to selecting <b>Breakpoints &gt; Breakpoint Properties</b> with the Breakpoints window frontmost.</p>
Groups tab		Click to display the <b>Groups</b> page. This page lets you work with breakpoints, eventpoints, watchpoints, and internal breakpoints.
Instances tab		Click to display the <b>Instances</b> page. This page lets you work with breakpoints in the same way as the Groups page, but organizes breakpoints by Process and Thread instance.
Templates tab		Click to display the <b>Templates</b> page. This page lets you define breakpoint templates and specify a default breakpoint template.

**Table 18.2 Breakpoints Window Items (continued)**

Item	Icon	Explanation
Active		<p>Click the Active icon in the column to the left of a group, to disable all breakpoints, watchpoints, or eventpoints within that group. An Active icon may appear to the left of a group even when all of the breakpoints, watchpoints, or eventpoints in the group have been otherwise disabled separately.</p> <p>The Active icon in the column to the left of a condition indicates that the condition is active and will affect program execution when the breakpoint, eventpoint, or watchpoint is enabled.</p>
Inactive		<p>Click the Inactive icon in the column to the left of a group, to enable all breakpoints, watchpoints, or eventpoints within that group. An Inactive icon may appear to the left of a group even when all of the breakpoints, watchpoints, or eventpoints in the group have been otherwise enabled separately.</p> <p>The Inactive icon in the column to the left of a condition indicates that the condition is inactive and will not affect program execution when the breakpoint, eventpoint, or watchpoint is enabled.</p>

## Opening the Breakpoints Window

Use the **Breakpoints** window to view a list of breakpoints currently set in your projects.

To open the Breakpoints window, select **View > Breakpoints (Windows)** or **Window > Breakpoints Window** (Solaris, Linux).

**NOTE** Double-click a breakpoint in the Breakpoints window to display its associated source-code line in an editor window.

## Saving the Contents of the Breakpoints Window

You can save the contents of the Breakpoints window. This feature is useful for saving sets of breakpoint data, then later re-opening those sets.

To save contents of the Breakpoints window, select **File > Save** or **File > Save As**. Selecting **File > Save As** lets you specify the name and path to save the file that stores the contents.

## Working with Breakpoints

This section explains how to work with breakpoints in your source code and in the **Breakpoints** window.

---

### Setting a Breakpoint

Use the **Set Breakpoint** command to set a breakpoint. A regular breakpoint suspends program execution. The debugger does not execute the line of source code that contains the regular breakpoint.

The default breakpoint template in the **Templates** page of the **Breakpoints** window determines the type of breakpoint that the debugger sets. For information about setting default breakpoint template, see [Specifying the Default Breakpoint Template](#).

[Figure 18.2](#) shows some source code and the Breakpoints column to the left of the source code. Breakpoint icons appear in this column.

**Figure 18.2 Setting Breakpoints**

Breakpoints column

This icon indicates an active breakpoint. Click on the icon to clear the breakpoint.

Click the dash icon to set an active breakpoint at this line.

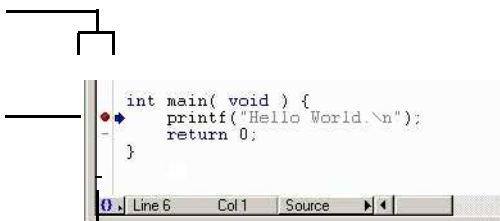

To set a breakpoint at a line of source code, click the Breakpoints column next to that line. The active breakpoint icon appears in the column. After you debug the project, the debugger halts program execution at the line that has the active breakpoint icon.



**TIP** You can also set a breakpoint for selected results in the Search Results window and for selected items in the Symbolics window.

If you debug your project first, dash icons appear in the Breakpoints column next to source-code lines at which you can set breakpoints. Click a dash icon to set a breakpoint at that line. The dash changes to an active breakpoint icon.

**NOTE** Setting a breakpoint in a file affects execution of all build targets that include that file.

## Viewing Breakpoint Properties

After you set a breakpoint, you can view and modify its properties. [Table 18.3](#) explains breakpoint properties.

To view properties for a breakpoint, select its name in the **Breakpoints** window and select **Breakpoints > Breakpoint Properties** or right-click the breakpoint name and select **Breakpoint Properties**.

**Table 18.3 Breakpoint properties**

Property	Explanation
Breakpoint Type	The type of item, such as Auto Breakpoint, Software Breakpoint, or Hardware Breakpoint.
Serial number	The non-persistent serial number that uniquely identifies the item in the IDE. Use this number to identify the item in scripting languages. This number is not the same number that the debugger plug-ins use to identify the item.
Condition	The conditional expression associated with the item. This conditional expression must evaluate to True in order for the item to perform its specified action.
Hit Count	Displays the number of times that program execution arrived at the breakpoint before the program stopped.
File-Info	The path to the file that contains the item.
Name	The name of the item, which appears in the Breakpoints window. The IDE creates a default name based on the item properties, but you can change this name to a more meaningful one. Use this name to identify the item in scripting languages.

## Manipulating Program Execution

### Breakpoints

**Table 18.3 Breakpoint properties (continued)**

Property	Explanation
Original Process	The persistent identifier for the active process at the time you set the item. If information about the active process was not available at the time you set the item, this identifier shows the process at the time the item affected program execution.
Original-Target	The path to the build target that contains the item.
Times Left	The number of times remaining for this item to affect program execution.
Thread	The thread in which the item takes effect.

## Disabling a Breakpoint

Disable a breakpoint to prevent it from affecting program execution. The disabled breakpoint remains at the source-code line at which you set it, so that you can enable it later.

To disable a breakpoint, click the enabled breakpoint icon next to a breakpoint in the **Breakpoints** window, or click the cursor on the source-code line that contains the breakpoint, and select **Debug > Disable Breakpoint**.

-  The enabled breakpoint icon changes to a disabled breakpoint icon (shown at left). The disabled breakpoint icon indicates that the breakpoint does not halt program execution.

## Enabling a Breakpoint

Enable a breakpoint to have it halt program execution. Enabling a breakpoint that you previously disabled is easier than clearing it and re-creating it from scratch.

To enable a breakpoint, click the disabled breakpoint icon next to the breakpoint in the **Breakpoints** window, or click the cursor on the source-code line that contains the breakpoint, and select **Debug > Enable Breakpoint**.

-  The disabled breakpoint icon changes to an enabled breakpoint icon (shown at left). The enabled breakpoint icon indicates that the breakpoint halts program execution.

---

## Clearing a Breakpoint

Use the **Clear Breakpoint** command to clear a breakpoint.

To clear a breakpoint in source code, click the cursor on the source-code line that contains the breakpoint and select **Debug > Clear Breakpoint**. You can also click the active breakpoint icon in the Breakpoints column to clear the breakpoint.

To clear a breakpoint in the **Breakpoints** window, select its name from the list in the **Groups**, **Instances**, or **Templates** pages and press Delete.

---

## Clearing All Breakpoints

Use the **Clear All Breakpoints** command to clear all breakpoints from your projects.

To clear all breakpoints, select **Debug > Clear All Breakpoints**. The **Breakpoints** window reflects your changes.

---

## Using the Run to Cursor Command

Use the **Run to Cursor** command to start the program where execution is currently halted and run to the line where the cursor is set. This command sets a *temporary breakpoint* at the cursor, starts execution, and then clears the temporary breakpoint the next time execution halts. Unlike a regular breakpoint that halts execution each time you get to that line of code, the temporary breakpoint associated with the Run To Cursor command halts execution only once. If you are executing a loop, execution does not stop a second time at the line at which you execute the Run to Cursor command, unless you execute the command a second time.

To use the Run to Cursor command, Alt-click the dash icon next to the line of code at which you wish to halt execution. The dash icon changes to an active breakpoint icon, and execution resumes. Once the debugger halts program execution at any line of code, including the lines of code marked with regular breakpoints, the temporary breakpoint is removed and the icon is also reverted to a single dashed-line. You can also use the cursor or keyboard to navigate to a particular line of code, and then use **Debug > Run to Cursor**.

---

## Setting a Conditional Breakpoint

Use the **Condition** column of the **Breakpoints** window to set a conditional breakpoint. A *conditional breakpoint* has an associated conditional expression.

---

## Manipulating Program Execution

### Breakpoints

---

The debugger evaluates the expression to determine whether to halt program execution at that breakpoint.

A conditional breakpoint behaves in two different ways:

- If the expression evaluates to true (a non-zero value), the debugger halts program execution.
- If the expression evaluates to false (a zero value), program execution continues without stopping.

Follow these steps to set a conditional breakpoint:

1. Set a breakpoint that you want to associate with a conditional expression.
2. Depending upon the menu layout set by the user, select **View > Breakpoints** (Windows) or **Window > Breakpoints Window** (Solaris, Linux).
3. In the **Groups** or **Instances** pages of the Breakpoints window, find the breakpoint that you want to associate with a conditional expression.
4. In the **Condition** column adjacent to a specific breakpoint, double-click to display a text box in the blank area.
5. Enter a “C” expression in the text box.

During subsequent debugging sessions, the debugger evaluates the expression to determine whether to halt program execution at the conditional breakpoint.

---

**NOTE** Alternatively, drag-and-drop an expression from a source view or from the Expression window into the Breakpoints window.

---

To signal a breakpoint to happen after the nth execution of the instruction, you can enter the keywords “Hit Count” in the condition text box. For example, if Hit Count is 0, then a condition of "Hit Count % 3 == 2" will cause a break every 3 times the breakpoint is encountered.

---

## Setting a Thread-Specific Conditional Breakpoint

The CodeWarrior debugger supports thread-specific breakpoints. Depending on what the protocol supports, there are several different ways it's supported. To set a thread-specific breakpoint:

1. In the Thread window, click the cursor on the source line code where you want to set the thread-specific breakpoint.
2. Right-click and select **Set Thread Specific Breakpoint** from the contextual menu.

## Working with Breakpoint Templates

This section explains how to define breakpoint templates, specify a default template, and delete templates.

A *breakpoint template* defines all properties of a breakpoint except for its location in source code. For example, you can define a breakpoint template that stops execution only 10 times, and only if an associated conditional expression evaluates to false.

The *default breakpoint template* is the breakpoint template that the debugger uses as the basis for new breakpoints that you set. For example, if you define a breakpoint template named **Thread Break**, you can specify it as the default breakpoint template. After you do this, the **Thread Break** template properties apply to all new breakpoints that you set in your source code.

The initial default breakpoint template is **Auto Breakpoint**, which defines the regular breakpoint that halts program execution at a line of source code. The CodeWarrior IDE also provides two other built-in breakpoint templates: **Software Breakpoint** and **Hardware Breakpoint**. These templates have default properties that are appropriate for software and hardware respectively.

You can change the default breakpoint template from **Auto Breakpoint** to other built-in templates, such as **Software Breakpoint** and **Hardware Breakpoint**, or any of the breakpoint templates you create. The next time you create a breakpoint, the IDE uses the template's default values for creating a breakpoint. You can also change the default breakpoint template back to **Auto Breakpoint**.

---

## Creating a Breakpoint Template

Use the **Templates** page of the **Breakpoints** window to define breakpoint templates. You define a breakpoint template by using an existing breakpoint as a starting point.

To define a breakpoint template, follow these steps:

1. Set a breakpoint in your source code.
2. Select **View > Breakpoints** (Windows) or **Window > Breakpoints Window** (Solaris, Linux).

The **Breakpoints** window appears.

3. Click the **Groups** tab.
4. Select the name of the breakpoint that you just set.

The debugger gives the breakpoint a default name that includes the name of the file in which you set the breakpoint and the line at which you set the breakpoint.

5. Click the **Create Breakpoint Template** button in the toolbar of the Breakpoints window.

## Manipulating Program Execution

### Breakpoints

---

6. Click the **Templates** tab of the Breakpoints window.

The new breakpoint template appears in this page with the name **New Template**.

You can rename the breakpoint template by selecting it and then selecting **Breakpoints > Rename Breakpoint**, or clicking the **Rename Breakpoint** button in the Breakpoints window toolbar, or pressing **Enter**.

---

**NOTE** You cannot rename built-in templates, such as **Auto Breakpoint**, **Software Breakpoint**, and **Hardware Breakpoint**.

---

---

### Deleting a Breakpoint Template

Use the **Templates** page of the **Breakpoints** window to delete the breakpoint templates that you no longer need.

To delete a breakpoint template, follow these steps:

1. Select **View > Breakpoints** (Windows) or **Window > Breakpoints Window** (Solaris, Linux).

The **Breakpoints** window appears.

2. Click the **Templates** tab of the Breakpoints window.
3. Select the breakpoint template that you want to delete.
4. Select **Edit > Delete** (Windows, Solaris, and Linux), or press **Delete**.

---

**NOTE** You cannot delete built-in templates, such as **Auto Breakpoint**, **Software Breakpoint**, and **Hardware Breakpoint**.

---

---

### Specifying the Default Breakpoint Template

Use the **Templates** page of the **Breakpoints** window to specify the default breakpoint template. The debugger uses this template as the basis for creating new breakpoints in your source code.

The initial default breakpoint template is **Auto Breakpoint**, which defines the regular breakpoint. You can specify any of the built-in templates or one of your breakpoint templates as the default breakpoint template.

To specify the default breakpoint template, follow these steps:

1. Select **View > Breakpoints** (Windows) or **Window > Breakpoints Window** (Solaris, Linux).

The **Breakpoints** window appears.

---

2. Click the **Templates** tab of the Breakpoints window.
3. Select the breakpoint template that you want to specify as the default breakpoint template.
4. Select **Breakpoints > Set Default Breakpoint Template** or click the Set Default Breakpoint Template button in the Breakpoints window toolbar.

The debugger will now use the breakpoint template that you have specified as the basis for creating new breakpoints in your source code.

## Eventpoints

You use *eventpoints* to perform a task when program execution arrives at a specific line of source code or when an associated conditional expression evaluates to true. You can set an eventpoint that performs a task such as running a script, playing a sound, or collecting trace data. An eventpoint is equivalent to a breakpoint that performs a task other than halting program execution.

You can use several kinds of eventpoints. The Breakpoints column represents these eventpoints with various icons. You can set more than one eventpoint on the same line of source code. The Breakpoints column shows all eventpoints that you set for each line.

[Table 18.4](#) explains different type of eventpoints and shows their corresponding icons.



**Table 18.4 Eventpoints**

Eventpoint	Icon	Explanation
<a href="#">Log Point</a>		Logs or speaks a string or expression and records messages to the Log window
<a href="#">Pause Point</a>		Pauses execution long enough to refresh debugger data
<a href="#">Script Point</a>		Runs a script, application, or other item
<a href="#">Skip Point</a>		Skips execution of a line of source code
<a href="#">Sound Point (Windows OS)</a>		Plays a sound

## Manipulating Program Execution

### Eventpoints

**Table 18.4 Eventpoints (continued)**

Eventpoint	Icon	Explanation
<a href="#">Trace Collection Off</a>		Stops collecting trace data for the Trace window
<a href="#">Trace Collection On</a>		Starts collecting trace data for the Trace window

You can also create breakpoint templates to simplify the process of setting complex eventpoints. Creating a breakpoint template for an eventpoint is nearly identical to creating a breakpoint template for a breakpoint. The difference is using an eventpoint instead of a breakpoint as the starting point for creating the breakpoint template.

Eventpoints have *enabled* and *disabled* states. [Table 18.5](#) explains these states.

**Table 18.5 Eventpoint States**

State	Icon	Explanation
Enabled	See <a href="#">Table 18.4</a>	Indicates that the eventpoint is currently enabled. The debugger performs the specified task at an enabled eventpoint. Click the icon, in the Breakpoints window, to disable the eventpoint.
Disabled		Indicates that the eventpoint is currently disabled. The debugger does not perform the specified task at a disabled eventpoint. Click the icon, in the Breakpoints window, to enable the eventpoint.

**TIP** You can set an eventpoint in the Thread window and for selected variables in the Symbolics window.

## Log Point

A Log Point logs or speaks a string or expression. A Log Point can also record messages to the Log window. You can configure the message that appears in the log window.

### Setting a Log Point

To set a Log Point, follow these steps:



1. Click the cursor on the line of source code at which you want to set the Log Point.
2. Right-click and select **Set Eventpoint > Set Log Point** from the context menu, or select **Debug > Set Eventpoint > Set Log Point**.

The **Log Point Settings** window (Figure 18.3) appears.

**Figure 18.3 Log Point Settings Window**

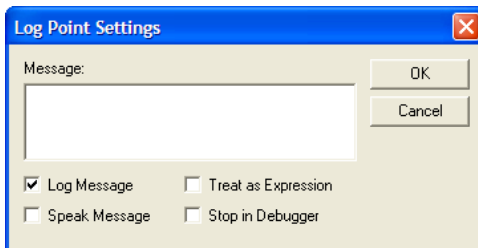

3. Enter the text of your log message in the **Message** text box.
4. Check at least one of these checkboxes:
  - **Log Message**—check to have the IDE display your message in a Message window when program execution reaches the Log Point
  - **Speak Message (Windows OS)**—check to have the IDE use the sound capabilities of the host operating system to speak the message that you enter in the **Message** text box.

---

**NOTE** (Windows) Install the Speech software development kit (SDK) in order to have the **Speak Message** feature work correctly.

---

- **Treat as Expression**—check to have the IDE evaluate the text you enter in the Message text box as an expression. For example, if you enter the name of a variable in the Message text, the debugger writes the value of that variable in the console output window.
  - **Stop in Debugger**—check to stop program execution in the debugger
5. Click the **OK** button to confirm your settings.

**Example use:** If you want to display the value of a variable each time some code is executed, set a log point, check the Log Message and Treat as expression checkboxes and enter the variable name in the Message text box, then click OK.

---

## Clearing a Log Point

To clear a Log Point, follow these steps:

## Manipulating Program Execution

### Eventpoints

---

1. Select the Log Point that you want to clear.  
Click the cursor on the line of source code that has the Log Point, or select the Log Point by name in the **Breakpoints** window.
2. Select **Debug > Clear Eventpoint > Clear Log Point** or select the Log Point in the Breakpoints window and press Delete.

## Pause Point

A Pause Point suspends program execution long enough to refresh debugger data. For example, without setting a pause point, you must wait for the debugger to halt program execution before it can refresh data. Setting a Pause Point, however, lets you pause the debugging session to give the debugger time to refresh the data.

---

## Setting a Pause Point

To set a Pause Point, follow these steps:

1. Click the cursor on the line of source code at which you want to set the Pause Point.
2. Right-click and select **Set Eventpoint > Set Pause Point** from the context menu, or select **Debug > Set Eventpoint > Set Pause Point**.

---

## Clearing a Pause Point

To clear a Pause Point, follow these steps:

1. Select the Pause Point that you want to clear.  
Click the cursor on the line of source code that has the Pause Point, or select the Pause Point by name in the **Breakpoints** window.
2. Select **Debug > Clear Eventpoint > Clear Pause Point** or select the Pause Point in the Breakpoints window and press Delete.

## Script Point

A Script Point runs a script, application, or other item. After you set a Script Point at a line of source code, its associated action occurs when program execution arrives at that line. For example, you can set a Script Point that performs these actions:

- (Windows) execute a file as if you had used a Windows command line

## Setting a Script Point

To set a Script Point, follow these steps:

1. Click the cursor on the line of source code at which you want to set the Script Point.
2. Right-click and select **Set Eventpoint > Set Script Point** from the context menu, or select **Debug > Set Eventpoint > Set Script Point**.

The **Script Point Settings** window (Figure 18.4) appears.

**Figure 18.4** Script Point Settings Window

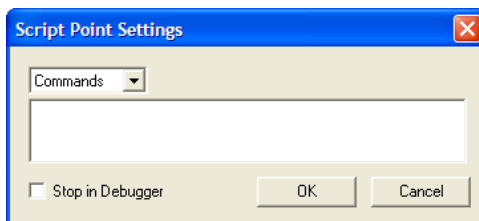

3. Use the list box to specify **Commands** or **Script File**.  
Specify **Commands** (Windows) if you intend to enter a command line that executes a file. Specify **Script File** if you intend to enter a path to a script file.
4. Enter the text of your Script Point in the text box.  
Enter a command line or a path to a script file.
5. Check **Stop in Debugger** if you want to stop program execution in the debugger.
6. Click the **OK** button to confirm your settings.

---

## Clearing a Script Point

To clear a Script Point, follow these steps:

1. Select the Script Point that you want to clear.  
Click the cursor on the line of source code that has the Script Point, or select the Script Point by name in the **Breakpoints** window.
2. Select **Debug > Clear Eventpoint > Clear Script Point**, or select the Script Point in the Breakpoints window and press Delete.

## Skip Point

A Skip Point prevents the debugger from executing a line of source code. This eventpoint is useful when you are aware of a line that you need to fix, but would like to go ahead and debug the rest of the program. You can set a Skip Point at that line and have the debugger execute the rest of the project without executing that particular line.

---

**NOTE** Skip Points do not work with the Java programming language.

---

---

## Setting a Skip Point

To set a Skip Point, follow these steps:

1. Click the cursor on the line of source code at which you want to set the Skip Point.
2. Right-click and select **Set Eventpoint > Set Skip Point** from the context menu, or select **Debug > Set Eventpoint > Set Skip Point**.

---

## Clearing a Skip Point

To clear a Skip Point, follow these steps:

1. Select the Skip Point that you want to clear.  
Click the cursor on the line of source code that has the Skip Point, or select the Skip Point by name in the **Breakpoints** window.
2. Select **Debug > Clear Eventpoint > Clear Skip Point**, or select the Skip Point in the Breakpoints window and press Delete.

## Sound Point (Windows OS)

A Sound Point is an audible alert. You can set a Sound Point so that when you step or run through code, the IDE plays a sound when program execution arrives at the line that has a Sound Point. Unlike a Log Point set to **Speak Message**, which speaks the message you specify, the Sound Point plays a simple notification sound.

---

## Setting a Sound Point

To set a Sound Point, follow these steps:

1. Click the cursor on the line of source code at which you want to set the Sound Point.
2. Right-click and select **Set Eventpoint > Set Sound Point** from the context menu, or select **Debug > Set Eventpoint > Set Sound Point**.

The **Sound Point Settings** window ([Figure 18.5](#)) appears.

**Figure 18.5 Sound Point Settings Window**

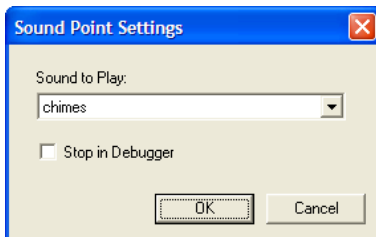

3. Use the **Sound to Play** list box to specify the notification sound that you want the IDE to play when program execution arrives at the Sound Point.
4. Check **Stop in Debugger** if you want to stop program execution in the debugger.
5. Click the **OK** button to confirm your settings.

---

## Clearing a Sound Point

To clear a Sound Point, follow these steps:

1. Select the Sound Point that you want to clear.  
Click the cursor on the line of source code that has the Sound Point, or select the Sound Point by name in the **Breakpoints** window.
2. Select **Debug > Clear Eventpoint > Clear Sound Point**, or select the Sound Point in the Breakpoints window and press Delete.

## Trace Collection Off

A Trace Collection Off eventpoint stops the collection of trace data. This eventpoint is useful when you want trace collection to stop when program execution reaches a line of source code that you specify.

---

## Setting a Trace Collection Off Eventpoint

To set a Trace Collection Off eventpoint, follow these steps:

## Manipulating Program Execution

### Eventpoints

---

1. Click the cursor on the line of source code at which you want to set the Trace Collection Off eventpoint.
2. Right-click and select **Set Eventpoint > Set Trace Collection Off** from the context menu, or select **Debug > Set Eventpoint > Set Trace Collection Off**.

---

### Clearing a Trace Collection Off Eventpoint

To clear a Trace Collection Off eventpoint, follow these steps:

1. Select the Trace Collection Off eventpoint that you want to clear.  
Click the cursor on the line of source code that has the Trace Collection Off eventpoint, or select the Trace Collection Off eventpoint by name in the **Breakpoints** window.
2. Select **Debug > Clear Eventpoint > Clear Trace Collection Off**, or select the Trace Collection Off eventpoint in the Breakpoints window and press Delete.

## Trace Collection On

A Trace Collection On eventpoint starts the collection of trace data. This eventpoint is useful when you want trace collection to start when program execution reaches a line of source code that you specify.

---

### Setting a Trace Collection On Eventpoint

To set a Trace Collection On eventpoint, follow these steps:

1. Click the cursor on the line of source code at which you want to set the Trace Collection On eventpoint.
2. Right-click and select **Set Eventpoint > Set Trace Collection On** from the context menu, or select **Debug > Set Eventpoint > Set Trace Collection On**.

---

### Clearing a Trace Collection On Eventpoint

To clear a Trace Collection On eventpoint, follow these steps:

1. Select the Trace Collection On eventpoint that you want to clear.  
Click the cursor on the line of source code that has the Trace Collection On eventpoint, or select the Trace Collection On eventpoint by name in the **Breakpoints** window.
2. Select **Debug > Clear Eventpoint > Clear Trace Collection On**, or select the Trace Collection On eventpoint in the Breakpoints window and press Delete.

## Working with Eventpoints

This section explains how to work with eventpoints in your source code and in the **Breakpoints** window.

---

### Viewing Eventpoint Properties

After you set an eventpoint, you can view and modify its properties.

To view properties for an eventpoint, select its name in the **Breakpoints** window and click **Breakpoints > Breakpoint Properties** or right-click the eventpoint and select **Breakpoint Properties**.

---

### Disabling an Eventpoint

Disable an eventpoint to prevent it from performing its specified action. The disabled eventpoint remains at the source-code line at which you set it, so that you can enable it later.

To disable an eventpoint, follow these steps:

1. Select the eventpoint that you want to disable.  
Select the eventpoint by name in the **Breakpoints** window, or click the cursor on the source-code line that contains the eventpoint.
  2. Select **Debug > Disable Eventpoint > Disable Eventpoint** command, where *Eventpoint* is the type of eventpoint that you want to disable, or right-click the eventpoint and select **Disable Eventpoint > Disable Eventpoint**.  
You can also disable an eventpoint by clicking the active eventpoint icon in the Breakpoints window.  
 The enabled eventpoint icon changes to a disabled eventpoint icon (shown at left). The disabled eventpoint icon indicates that the eventpoint does not perform its specified action.
- 

### Enabling an Eventpoint

Enable an eventpoint to have it perform its specified action during program execution. Enabling an eventpoint that you previously disabled is easier than clearing it and re-creating it from scratch.

To enable an eventpoint, follow these steps:

## Manipulating Program Execution

### Eventpoints

---

1. Select the eventpoint that you want to enable.

Select the eventpoint by name in the **Breakpoints** window, or click the cursor on the source-code line that contains the eventpoint.

2. Select **Debug > Enable Eventpoint > Enable Eventpoint** command, where *Eventpoint* is the type of eventpoint that you want to enable, or right-click the eventpoint and select **Enable Eventpoint > Enable Eventpoint**.

You can also enable an eventpoint by clicking the inactive eventpoint icon in the Breakpoints window.

The disabled eventpoint icon changes to its original eventpoint icon ([Table 18.4](#)). The enabled eventpoint icon indicates that the eventpoint will perform its specified action.

---

## Setting a Conditional Eventpoint

Use the **Condition** column of the **Breakpoints** window to set a conditional eventpoint. A *conditional eventpoint* has an associated conditional expression.

The debugger evaluates the expression to determine whether the eventpoint performs its specified action.

A conditional eventpoint behaves in two different ways:

- If the expression evaluates to true (a non-zero value), the eventpoint performs its specified action.
- If the expression evaluates to false (a zero value), the eventpoint does not perform its specified action.

Follow these steps to set a conditional eventpoint:

1. Set an eventpoint that you want to associate with a conditional expression.
2. Select **View > Breakpoints (Windows)** or **Window > Breakpoints Window** (Solaris, Linux).  
The **Breakpoints** window appears.
3. In the **Groups** or **Instances** pages of the Breakpoints window, find the eventpoint that you want to associate with a conditional expression.
4. Double-click the **Condition** column adjacent to the eventpoint to display a text box in the blank area.
5. Enter an expression in the text box.

During subsequent debugging sessions, the debugger evaluates the expression to determine whether the eventpoint performs its specified action.



**NOTE** Alternatively, drag-and-drop an expression from a source view or from the Expression window into the Breakpoints window.

---

## Watchpoints

You use *watchpoints* (sometimes referred to as access breakpoints or memory breakpoints) to halt program execution when your program reads or writes to a specific memory location. You can then examine the call chain, check register and variable values, and step through your code. You can also change values and alter the flow of normal program execution.

Debugger stops the program execution at the watchpoint if the [Stop at Watchpoints](#) checkbox in the **Debugger Settings** panel is checked. If cleared, the debugger reports the watchpoint in a message window.



**NOTE** You cannot set watchpoint on local variable, because the debugger cannot detect watchpoints for variables stored on the stack or in registers.

---

You can create breakpoint templates to simplify the process of setting complex watchpoints. Creating a breakpoint template for a watchpoint is nearly identical to creating a breakpoint template for a breakpoint. The difference is using a watchpoint instead of a breakpoint as the starting point for creating the breakpoint template.

Watchpoints have *enabled* and *disabled* states. [Table 18.6](#) explains these states. [Figure 18.6](#) displays the watchpoint enabled and disabled states in Memory window.

**Table 18.6 Watchpoint States**

State	Icon	Explanation
Enabled		Indicates that the watchpoint is currently enabled. The debugger halts program execution at an enabled watchpoint. Click the icon, in the Breakpoints window, to disable the watchpoint.
Disabled		Indicates that the watchpoint is currently disabled. The debugger does not halt program execution at a disabled watchpoint. Click the icon, in the Breakpoints window, to enable the watchpoint.

## Manipulating Program Execution

### Watchpoints

**NOTE** Different hardware targets have varying rules regarding the number of watchpoints that may be set at any one time. Consult your targeting manual for watchpoint information specific to your target.

**Figure 18.6 Watchpoint States in Memory Window**

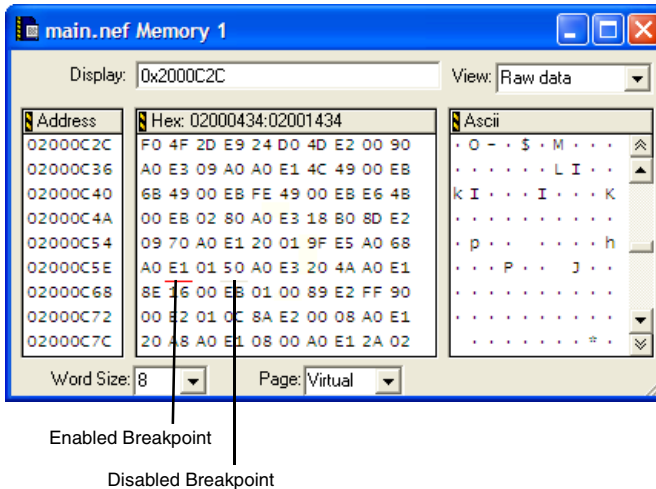

**NOTE** Some hardware targets also support read-write, read, and write watchpoints. For information about these watchpoints, see the *Targeting* documentation.

## Setting a Watchpoint

Use the **Set Watchpoint** command to set a watchpoint. A watchpoint suspends program execution when the memory location that you specify changes value. The debugger does not execute the line of source code that contains the watchpoint.

**NOTE** The watchpoint implementation differs between CodeWarrior products, and the steps below may not completely describe your watchpoint setting process. For example, some products let you specify additional watchpoint parameters such as whether you are setting a read or a write watchpoint.

To set a watchpoint on a memory range, follow these steps:

1. Select **Project > Debug**.  
A debugging session starts.
2. Select **Data > View Memory**.  
A **Memory** window appears.
3. Select a range of bytes in the Memory window.  
Do not double-click the range of bytes.
4. Right-click and select **Set Watchpoint** from the context menu, or select **Debug > Set Watchpoint**.  
An underline appears beneath the selected range of bytes, indicating that you have set a watchpoint in that range.

---

**TIP** You can change the color of the watchpoint underline in the **Display Settings** panel of the **IDE Preferences** window

---

To set a watchpoint on a variable in the thread window or variable window, follow these steps:

1. Make the thread window or variable window active.
2. Right-click the variable in the variables pane.
3. From the context menu, select **Set Watchpoint**.

---

## Viewing Watchpoint Properties

After you set a watchpoint, you can view and modify its properties.

To view properties for a watchpoint, select its name in the **Breakpoints** window and select **Breakpoints > Breakpoint Properties**, or right-click the watchpoint and select **Breakpoint Properties**.

---

## Disabling a Watchpoint

Disable a watchpoint to prevent it from affecting program execution. The disabled watchpoint remains at the memory location at which you set it, so that you can enable it later.

To disable a watchpoint, select its name in the **Breakpoints** window, or select the range of bytes in the **Memory** window at which you set the watchpoint, and select **Debug > Disable Watchpoint**. You can also click the active watchpoint icon in the Breakpoints window to disable a watchpoint.

## Manipulating Program Execution

### Watchpoints

---

- The disabled watchpoint icon appears (shown at left), which indicates an disabled watchpoint.

---

### Enabling a Watchpoint

Enable a watchpoint to have it halt program execution when its associated memory location changes value.

To enable a watchpoint, select its name in the **Breakpoints** window, or select the range of bytes in the **Memory** window at which you set the watchpoint, and select **Debug > Enable Watchpoint**. You can also click the inactive watchpoint icon in the Breakpoints window to enable a watchpoint.

- The enabled watchpoint icon appears (shown at left), which indicates an enabled watchpoint.

---

### Clearing a Watchpoint

Use the **Clear Watchpoint** command to clear a watchpoint.

To clear a watchpoint in the Memory window, select range of bytes at which you set the watchpoint and select **Debug > Clear Watchpoint**.

To clear a watchpoint in the **Breakpoints** window, select its name from the list in the **Groups** or **Instances** pages and press Delete.

---

### Clearing All Watchpoints

Use the **Clear All Watchpoints** command to clear all watchpoints from your projects.

To clear all watchpoints, select **Debug > Clear All Watchpoints**. The **Breakpoints** window reflects your changes.

---

### Setting a Conditional Watchpoint

Use the **Condition** column of the **Breakpoints** window to set a conditional watchpoint. A *conditional watchpoint* has an associated conditional expression.

The debugger evaluates the expression to determine whether to halt program execution at that watchpoint.

A conditional watchpoint behaves in two different ways:

- If the expression evaluates to true (a non-zero value), the debugger halts program execution when the memory location associated with the watchpoint changes value.
- If the expression evaluates to false (a zero value), program execution continues without stopping.

Follow these steps to set a conditional watchpoint:

1. Set a watchpoint that you want to associate with a conditional expression.
2. Select **View > Breakpoints** (Windows) or **Window > Breakpoints Window** (Solaris, Linux).

The **Breakpoints** window appears.

3. In the **Groups** or **Instances** pages of the Breakpoints window, find the watchpoint that you want to associate with a conditional expression.
4. Double-click the **Condition** column adjacent to the watchpoint.
5. Enter an expression in the **Condition** text box.

During subsequent debugging sessions, the debugger evaluates the expression to determine whether to halt program execution at the conditional watchpoint.

---

**NOTE** Alternatively, drag-and-drop an expression from a source view or from the Expression window into the Breakpoints window.

---

## Special Breakpoints

*Special breakpoints* halt program execution for very specific reasons:

- program execution arrives at the beginning of the function `main()`
- a C++ or Java exception occurs
- an event occurs that the debugger plug-in defines as a break event

You cannot change or delete special breakpoints, but you can enable and disable them.

---

### Disabling Special Breakpoints

Disable special breakpoints to prevent them from affecting program execution.



To disable special breakpoints, click the Active icon (shown at left) to the left of the **Special** group in the **Groups** page of the **Breakpoints** window.

## Manipulating Program Execution

### Special Breakpoints

---

**NOTE** When you click the Active icon, only the already established special breakpoints are disabled. The special breakpoints that are set after clicking the Active icon remain in active state.

---

The active icon changes to a inactive icon, which indicates that the special breakpoints are disabled.

---

## Enabling Special Breakpoints

Enable special breakpoints to have them halt program execution.

 To enable special breakpoints, click the Inactive icon (shown at left) to the left of the **Special** group in the **Groups** page of the **Breakpoints** window.

The inactive icon changes to an active icon, which indicates that the special breakpoints are enabled.

# Working with Variables

---

This chapter explains how to work with variables in a CodeWarrior™ IDE debugging session. The following windows show various types of information about variables.

- Global Variables window—shows information about global and static variables in your project
- Variable window—shows information for an individual variable in your project
- Expressions window—shows variable values and lets you perform calculations, such as adding a constant value or another variable to a variable and view results

This chapter consists of these sections:

- [Global Variables Window](#)
- [Variable Window](#)
- [Expressions Window](#)

## Global Variables Window

The **Global Variables** window shows all global and static variables for each process that you debug. You can open separate Global Variables windows for each process in the same build target. Use the window to observe changes in variable values as the program executes.

[Figure 19.1](#) shows the Global Variables window. [Table 19.1](#) explains the items in the window.

## Working with Variables

### Global Variables Window

Figure 19.1 Global Variables Window

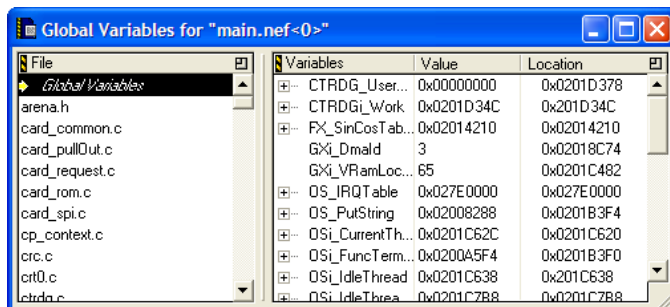

Table 19.1 Global Variables Window Items

Item	Explanation
File	Lists source files that declare global or static variables. Click a source file to view its static variables. Click <b>Global Variables</b> to view all global variables declared in the program.
Variables	Lists variables according to the file selected in the File pane. Double-click a variable to display it in a separate Variable window.
Value	Shows the current value of each corresponding variable. Double-click a value to change it.
Location	Shows the address of each variable in memory. Double-click to view the location in the <a href="#">Memory Window</a> .

## Opening the Global Variables Window

Use the Global Variables window to display global variables declared in a program or static variables declared in source files that comprise the program.

To open the Global Variables window, select **View > Global Variables** (Windows) or **Window > Global Variables Window** (Linux, Solaris).

## Viewing Global Variables for Different Processes

You can open a separate Global Variables window for each process that the same parent application creates.



To open the Global Variables window for a particular process, follow these steps:

1. Select **Project > Debug**.  
A debugging session starts.
2. In the Thread window toolbar, use the Process list box to specify the process that has the global variables that you want to examine.
3. Select **View > Global Variables (Windows)** or **Window > Global Variables Window (Linux, Solaris)**.

Repeat these steps for each process that has global variables that you want to examine.

## Variable Window

A Variable window allows manipulation of a single variable or variable hierarchy used in source code. For a local variable, the window closes after program execution exits the routine that defines the variable.

[Figure 19.2](#) shows the Variable window.

**Figure 19.2 Variable Window**

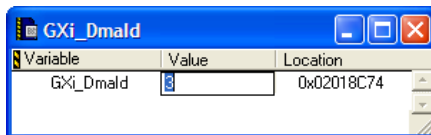

### Opening a Variable Window

- Select a variable in the editor window and select **Data > View Variable**.
- Double-click a variable in the **Global Variables** window.

A Variable window appears. Double-click the value of the variable to change it.

**TIP** Use Variable windows to monitor individual variables independently of other windows. For example, use a Variable window to continue monitoring a variable that leaves the current scope of program execution in the Thread window.

Alternatively, use a contextual menu to open a Variable window, as [Table 19.2](#) explains.

## Working with Variables

### Variable Window

**Table 19.2** Opening a Variable Window by Using a Contextual Menu

On this host...	Do this...
Windows	Right-click the variable and select <b>View Variable</b> .
Solaris	Click and hold on the variable, then select <b>View Variable</b> .
Linux	Click and hold on the variable, then select <b>View Variable</b> .

## Manipulating Variable Formats

You can change the way the Variables window displays data. For example, you can add labels to variable data so that those labels appear in the Variables window and clarify the displayed data.

For example, suppose you have the structure that [Listing 19.1](#) defines.

**Listing 19.1** Sample Structure Definition

```
struct Rect {
    short          top;
    short          left;
    short          bottom;
    short          right;
};
```

The Variables window might show an instance of the `Rect` structure like this:

```
myRect      0x00DCEA8
```

You can create an XML file that defines a new way to display the structure, as [Listing 19.2](#) shows.

**Listing 19.2** Sample Variable Format Definition

```
<variableformats>
  <variableformat>
    <osname>osWin32</osname>
    <runtimeName>runtimeWin32</runtimeName>
    <typeName>Rect</typeName>
    <expression>
      "{T: " + ^var.top +
      " L: " + ^var.left +
      " B: " + ^var.bottom +
      " R: " + ^var.right +
```

```

    "}{H: " + (^var.bottom - ^var.top) +
    " W: " + (^var.right - ^var.left) + "}"
  </expression>
</variableformat>
</variableformats>

```

Given this new variable format definition, the Variables window now shows the same `myRect` instance like this:

```
myRect {T: 30 L: 30 B: 120 R: 120}{H: 90 W: 90}
```

To manipulate variable formats, you place an XML file that defines the new format inside the `VariableFormats` directory at

`CodeWarrior/Bin/Plugins/Support/VariableFormats/`

where `CodeWarrior` is the path to your CodeWarrior installation.

The IDE reads the XML files in this directory to determine how to display variable data. [Table 19.3](#) explains the main XML tags that the IDE recognizes.

**Table 19.3 Variable Format XML Tags**

Tag	Explanation
<code>variableformats</code>	A group of variable format records.
<code>variableformat</code>	An individual variable format record.
<code>osname</code>	The operating system that defines the scope of this record.
<code>runtimeName</code>	The runtime that defines the scope of this record.
<code>typeName</code>	The name of the Type that this record will format.
<code>expression</code>	The expression that reformats the variable display. The IDE evaluates this expression to determine the format that it applies to the variable. The IDE replaces all occurrences of the <code>^var</code> placeholder with the name of the variable.

## Expressions Window

The **Expressions** window ([Figure 19.3](#)) helps you monitor and manipulate these kinds of items:

- global and local variables
- structure members

## Working with Variables

### Expressions Window

- array elements

[Table 19.4](#) explains items of this window.

**Figure 19.3 Expressions Window**

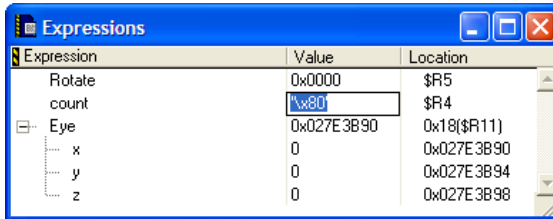

**Table 19.4 Expressions Window Items**

Item	Explanation
Expression column	Lists expressions and expression hierarchies. Click the hierarchical controls to expand or collapse the expression view.
Value column	Shows the current value of each corresponding expression. Double-click a value to change it.
Location column	Shows the address of each expression in memory. Double-click to view the location in the <a href="#">Memory Window</a> .

## Opening the Expressions Window

Use the Expressions window to inspect frequently used variables as their values change during a debugging session.

To open the Expressions window, select **View > Expressions (Windows)** or **Window > Expressions Window** (Linux, Solaris).



Alternatively, click the Expressions button in the Thread window toolbar to open the Expressions window.

## Adding Expressions

The Expressions window handles various ways of adding expressions for inspection.

To add an expression to the Expressions window, do this:

- Select the desired expression and select **Data > Copy To Expression**, or

- Use the contextual menu with a selected expression, or
- Drag and drop an expression from another window into the Expressions window.

The Expressions window reflects the added expression. Drag expressions within the window to reorder them.

---

## Adding a Constant Value to a Variable

You can enter an expression in the Expressions window that adds a constant value to a variable. Suppose  $x$  is a short integer type in the variable context of some function scope in C++ code. You can enter the expression  $x+1$  and the IDE computes the resulting value just as you would compute it on a calculator.

1. Select the variable to which you want to add a constant value.

For example, select  $x$ .

2. Enter an expression that adds a constant value to the variable.

For example, append  $+1$  to  $x$  so that the resulting expression is  $x+1$ .

The IDE adds the constant value to the variable and displays the result in the Expressions window.

---

## Making a Summation of Two Variables

You can enter an expression in the Expressions window that computes the sum of two variables. Suppose  $x$  is a short integer type in the variable context of some function scope in C++ code. You can enter the expression  $x+y$  and the IDE computes the resulting value just as you would compute it on a calculator.

1. Select the variable to which you want to add another variable.

For example, select  $x$ .

2. Enter an expression that adds a second variable to the first variable.

For example, append  $+y$  to  $x$  so that the resulting expression is  $x+y$ .

The IDE computes the sum of the two variables and displays the result in the Expressions window.

---

## Removing Expressions

The Expressions window handles various ways of removing expressions that no longer require inspection.

To remove an expression from the Expressions window:

---

## Working with Variables

### *Expressions Window*

---

- Select the expression and select **Edit > Delete** or **Edit > Clear**, or
- Select the expression and press the Backspace or Delete key.

The Expressions window updates to reflect the removed expression.

---

**NOTE** Unlike the Variable window, the Expressions window does not remove a local variable after program execution exits the routine that defines the variable.

---

# Working with Memory

---

This chapter explains how to work with memory in a CodeWarrior™ IDE debugging session. The following windows show various types of information about memory:

- Memory window—shows the memory that your project manipulates as it executes
- Array window—shows the contents of arrays that your project manipulates as it executes
- Registers window—shows the register contents of a processor
- Register Details window—shows a graphical representation of processor registers and explains register contents
- Cache window—shows processor or instructor cache data
- Trace window—shows collected trace information

This chapter consists of these sections:

- [Memory Window](#)
- [Array Window](#)
- [Registers Window](#)
- [Register Details Window](#)

## Memory Window

The Memory window manipulates program memory content in various data types. Use this resizable window to perform these tasks:

- View memory
- Change individual memory bytes
- Set watchpoints

---

**NOTE** Arbitrarily changing memory contents could degrade the stability of the IDE, another program, or the operating system itself. Understand the consequences of manipulating memory.

---

[Figure 20.1](#) shows the Memory window. [Table 20.1](#) explains the items in the window.

## Working with Memory

### Memory Window

Figure 20.1 Memory Window

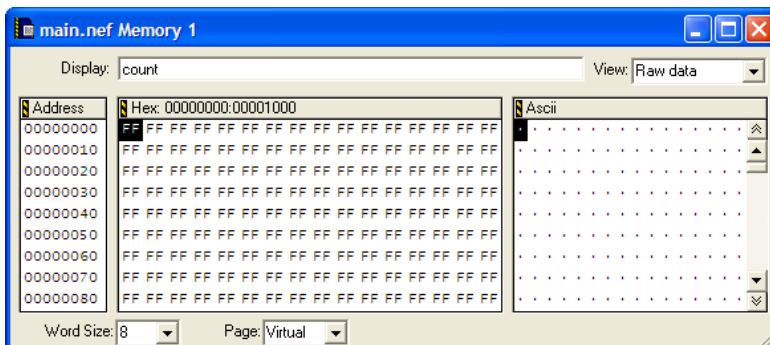

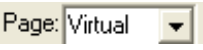

Table 20.1 Memory Window Items

Item	Icon	Explanation
Display		Enter a symbol representing the starting address of memory to display. Valid symbols include addresses and non-evaluating expressions, such as <code>main</code> or <code>x</code> .
View		Select the data format in which to view memory contents.
Memory Space (for processors that support multiple memory spaces)		Choose the memory space in which to view selected variables or source code.
Previous Memory Block		Click to view the preceding block of memory.
Next Memory Block		Click to view the succeeding block of memory.
Address		Displays a contiguous range of memory addresses, beginning with the address entered in the <b>Display</b> field.



**Table 20.1 Memory Window Items (continued)**

Item	Icon	Explanation
Hex		Displays a hexadecimal representation of the memory addresses shown in the <b>Address</b> pane.
Ascii		Displays an ASCII representation of the memory addresses shown in the <b>Address</b> pane.
Word Size		Select the bit size of displayed words.
Page (for processors that support multiple pages)		Select the memory-space page in which to view source code.

## Viewing and Changing Raw Memory

Use the **View Memory** command to view and change the raw contents of memory.

1. Select an item or expression that resides at the memory address to be examined.
2. Select **Data > View Memory**.  
A new Memory window appears.
3. Select **Raw data** from the **View** list box.

The contents of memory at the selected location appears in both hexadecimal and ASCII.

Scroll through memory by selecting the **Address**, **Hex**, or **ASCII** pane of the Memory window and then use the up and down arrow keys. Display a different memory location by changing the expression in the **Display** field.

Change the word size displayed in the Memory window by using the **Word Size** list pop-up. The choices are 8, 16, and 32 bits.

Change the contents of a particular memory location by double-clicking on that location in either the hexadecimal or ASCII pane of the Memory window. Replace the current value by entering a hexadecimal value in the **Hex** pane or a string of ASCII characters in the **ASCII** pane.

## Working with Memory

### Memory Window

Alternatively, use a contextual menu to view and change memory, as explained in [Table 20.2](#).

**Table 20.2 Opening a Memory Window by Using a Contextual Menu**

On this host...	Do this...
Windows	Right-click the item and select <b>View Memory</b> .
Solaris	Click and hold on the item, then select <b>View Memory</b> .
Linux	Click and hold on the item, then select <b>View Memory</b> .

### Viewing Memory Referenced by a Pointer

Use the **View Memory** command to inspect memory referenced by a pointer, including an address stored in a register.

1. Select a pointer in a source window.
2. Select **Data > View Memory**.  
A new Memory window appears.
3. Select **Raw data** from the **View** list box.  
The contents of memory referenced by the pointer appears in both hexadecimal and ASCII.

### Viewing Different Memory Spaces

Use the **Page** list box to view a particular memory space.

**NOTE** This feature is available only for processors that support multiple memory spaces.

1. Select the name of a variable or function in a source window.
2. Select **Data > View Memory**.  
A Memory window appears.
3. Select a memory space from the **Page** list box.
4. Select **Raw data** from the **View** list box if inspecting a variable. Select **Disassembly**, **Source**, or **Mixed** from the **View** list box if inspecting source code.  
The Memory window displays the selected memory-space page.

---

## Setting a Watchpoint in the Memory Window

To set a Watchpoint using the **Memory** window, follow these steps:

1. **Run/Debug** your program.
2. Select **Data > View Memory**.  
This opens the **Memory** window.
3. Select a range of bytes in the **Memory** window.  
Do not double-click the range of bytes.
4. Select **Debug > Set Watchpoint**.

---

**NOTE** A red line appears under the selected variable in the Variable window, indicating that you have set a Watchpoint. You can change the color of this line in the **Display Settings** panel of the IDE Preferences window (**Edit > IDE Preferences**).

---

---

## Clearing Watchpoints from the Memory window

To clear a Watchpoint from the Memory window, follow these steps:

1. Select a range of bytes in the Memory window.
2. Select **Debug > Clear Watchpoint**.

To clear *all* Watchpoints from the Memory window:

1. Open the Memory window.  
You do not have to select a range of bytes.
2. Select **Debug > Clear All Watchpoints**.

---

**NOTE** All Watchpoints clear automatically when the target program terminates or the debugger terminates the program. Watchpoints will reset next time the program runs.

---

# Array Window

An Array window allows manipulation of a contiguous block of memory, displayed as an array of elements. The window lists array contents sequentially, starting at element 0.

## Working with Memory

### Array Window

The Array window title shows the base address bound to the array. The base address can bind to an address, a variable, or a register. An array bound to a local variable closes after the routine that defines the variable returns to the calling routine.

For array elements cast as structured types, a hierarchical control appears to the left of each element. Use these hierarchical controls to expand or collapse the display of each element's contents.

[Figure 20.2](#) shows an Array window. [Table 20.3](#) explains the items in the window.

**Figure 20.2** Array window

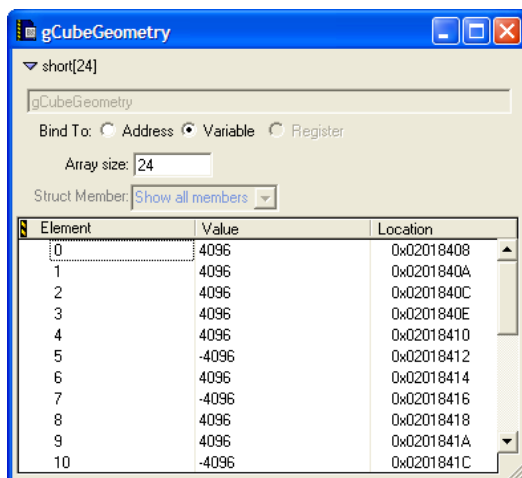

**Table 20.3** Array Window Items

Item	Icon	Explanation
Hierarchical control		Click to collapse the view of the information pane.
Bind To		Select the base address of the array: <b>Address</b> , <b>Variable</b> , or <b>Register</b> .
Array size		Enter the number of elements to display in the Array window.
Struct Member		Select a specific member to show in each element, or show all members.

Table 20.3 Array Window Items (*continued*)

Item	Icon	Explanation
Element		Shows the array elements in a hierarchical list.
Value		Shows the value of each array element.
Location		Shows the address in memory of each array element.

## Opening an Array Window

Use the **View Array** command to manipulate a memory block in an Array window.

1. Select the array that you want to view.
2. Select **Data > View Array**.

A new Array window appears.

**TIP** Drag and drop a register or variable name into an Array window to set the base address. Use the **View Memory As** command to interpret memory displayed in an Array window as a different type.

Alternatively, use a contextual menu to open an Array window, as [Table 20.4](#) explains.

Table 20.4 Opening an Array Window by Using a Contextual Menu

On this host...	Do this...
Windows	Right-click the array and select <b>View Array</b> .
Solaris	Click and hold on the array, then select <b>View Array</b> .
Linux	Click and hold on the array, then select <b>View Array</b> .

## Registers Window

The **Registers** window reveals a hierarchical view of these register types:

- general registers—contents of the central processing unit (CPU) of the host computer
- floating-point unit (FPU) registers—contents of the FPU registers

## Working with Memory

### Registers Window

- registers specific to the host computer

You can use the Registers window to perform these tasks:

- expand the hierarchical items in the window and view their contents
- select and modify register values
- view documentation for individual registers (depending on the register)

[Figure 20.3](#) shows a sample Registers window.

**Figure 20.3 Registers Window**

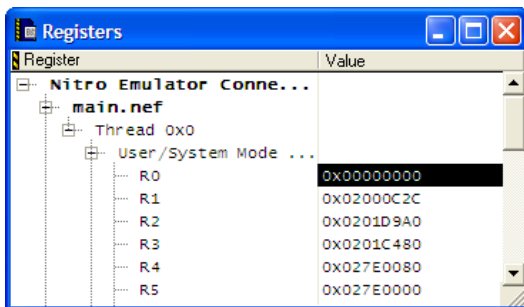

## General Registers

The **General Registers** are the register contents of the central processing unit (CPU) of the host computer. The exact listing of these registers depends on the host CPU and current build target. See the *Targeting* documentation for additional information.

## FPU Registers

The **FPU Registers** are the register contents of the floating-point unit (FPU) of the host computer. The exact listing of these registers depends on the host FPU and current build target. See the *Targeting* documentation for additional information.

## Host-specific Registers

The Registers window also lists additional register contents for registers specific to the host. The exact listing of these registers depends on the host computer and current build target. See the *Targeting* documentation for additional information.

## Opening the Registers Window

Open the **Registers** window to inspect and modify various register contents.

[Table 20.5](#) explains how to open the Registers window.

**Table 20.5** Opening the Registers Window

On this host...	Do this...
Windows	Select <b>View &gt; Registers</b>
Solaris	Select <b>Window &gt; Registers Window</b>
Linux	Select <b>Window &gt; Registers Window</b>

## Viewing Registers

View registers to inspect and modify their contents.

1. Open the **Registers** window.
2. Expand the hierarchical list to view register groups.  
Expanding the list shows the register groups that you can view or change.
3. Expand a register group.  
Expanding a group shows its contents, by register name and corresponding value.

## Changing Register Values

Change register values during program execution in order to examine program behavior.

1. Open the **Registers** window.
2. Expand the hierarchical list to view the names and corresponding values of the register that you want to modify.
3. Double-click the register value that you want to change.  
The value highlights.
4. Enter a new register value.
5. Press **Enter** or **Return**.  
The register value changes.

## Changing Register Data Views

Change register data views to see register contents in a different format. For example, you can change the view of a register from binary to hexadecimal format.

1. Open the **Registers** window.
2. Expand the hierarchical list to view the names and corresponding values of the register.
3. Select the register value that you want to view in a different format.  
The value highlights.
4. Select **Data > View as *format***, where *format* is the data format in which you want to view the register value. The register value changes format.  
Available formats depend on the selected register value.
5. Select **Data > View as Default** to restore the original data format.

Alternatively, you can use a contextual menu to change the data format, as [Table 20.6](#) explains.

**Table 20.6 Changing Data Format by Using a Contextual Menu**

On this host...	Do this...
Windows	Right-click the register value and select <b>View as <i>format</i></b> .
Solaris	Click and hold on the register value and select <b>View as <i>format</i></b> .
Linux	Click and hold on the register value and select <b>View as <i>format</i></b> .

## Opening Registers in a Separate Registers Window

Open registers in a separate Register Window to narrow the scope of registers that appear in a single window.

1. Open the **Registers** window.
2. Expand the hierarchical list to view the register or register group that you want to view in a separate Registers window.
3. Double-click the register or register group.
4. A new Registers window opens.



The new Registers window lists the name and value of the register or register group that you double-clicked.

## Register Details Window

The **Register Details** window lets you view detailed information about individual bits of registers from 2 bits to 32 bits in size. This window shows information for both system registers and memory-mapped registers. To open the Register Details window, select **View > Register Details** (Windows) or **Window > Register Details Window** (Linux, Solaris)

The Register Details window has fields that describe the register, its bitfields, and the values of those bitfields. XML files in the **Registers** folder of your CodeWarrior installation provide the information that appears in the window. The Registers folder is inside the `<CW_Install>\bin\Plugins\Support\Registers` folder. This folder contains different type of xml files, such as register details xml files and layout xml files.

[Figure 20.4](#) shows the Register Details window. [Table 20.7](#) explains items in the window.

**Figure 20.4 Register Details Window**

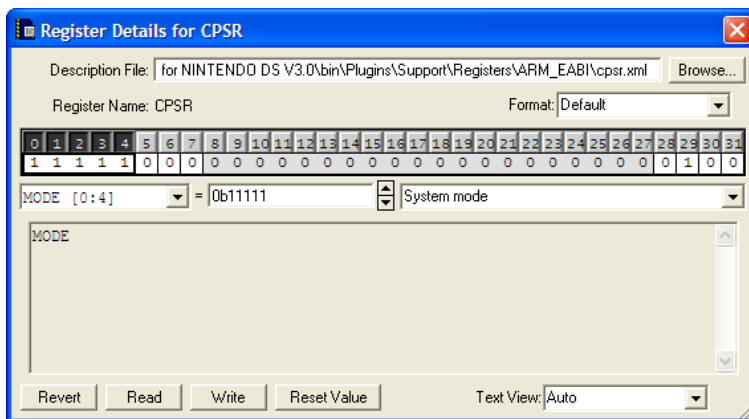

## Working with Memory

### Register Details Window

**Table 20.7 Register Details Window Items**

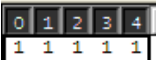
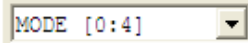
Item	Icon	Explanation
<a href="#">Description File</a> text box		Enter the name or full path to the XML file for the register you want to view, or click the <b>Browse</b> button to open a dialog box that you can use to specify the file.
Register Name		Shows the name of the register depicted in the window.
Address text box		Enter the starting address of the register values that you want to see in the Register Display.  An error message appears if you enter an invalid starting address.
Format list box		Specify the data format for bit values in the Register Display: <ul style="list-style-type: none"> <li>• Binary</li> <li>• Character</li> <li>• Decimal</li> <li>• Unsigned Decimal</li> <li>• Hexadecimal</li> <li>• Default—have the IDE determine the best format</li> </ul>
<a href="#">Register Display</a>		Shows a depiction of the register that you specify in the <b>Description File</b> text box, including individual register bits and their values.
Bitfield Name list box		Specify a bitfield to highlight in the Register Display. The Description portion of the window reflects available information for the bitfield.  Select <b>None</b> to have the Description portion of the window reflect information for the entire register and not a bitfield in that register.

**Table 20.7 Register Details Window Items (continued)**

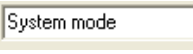
Item	Icon	Explanation
Bit Value text box		Shows the current value of the bits in the Bitfield Name list box, according to the format that you specify in the <b>Format</b> list box.  Click the spin buttons to increment or decrement the current value, or enter a new value in the text box.  Changing the value changes only the Register Display. You must click the <b>Write</b> button to write the new value to the register itself.
Bit Value Modifier list box		Specify a new value for the selected bitfield, or view a brief explanation of specific bitfield values.  Changing the value changes only the Register Display. You must click the <b>Write</b> button to write the new value to the register.
Description		Shows a description of the register or a selected bitfield in the register.  Use the <a href="#">Description File</a> text box to specify the register.  Use the <a href="#">Text View</a> list box to view specific register information, such as register descriptions, bitfield descriptions, and register details.
Revert button		Click to change a modified value in the Register Display to its original value.  If you clicked the <b>Write</b> button to write a new value to the register, you cannot revert that value.
Read button		Click to have the Register Display reflect current bit values from the register itself.
Write button		Click to write the bit values in the Register Display to the register.  After you write new values to the register, you cannot revert them.

## Working with Memory

### Register Details Window

**Table 20.7 Register Details Window Items (continued)**

Item	Icon	Explanation
Reset Value button		Click to restore the default value for the selected bitfield.  The IDE disables this button if the selected bitfield does not have a default value.
<a href="#">Text View</a> list box		Use to specify information that appears in the Description portion of the window.

## Description File

Enter in this text box the name of the register that you want to see in the Register Display of the **Register Details** window. The file name can be the name of a register itself.

After you enter a name or path, the debugger searches for a matching register description file in the **Registers** folder of your CodeWarrior installation and the project access paths. If the debugger finds a matching file, the Register Display updates the information in the Register Details window. If the debugger does not find a matching name, an error message appears.

For example, to view the contents of the Opcode register, you can:

- type `Opcode` in the **Description File** text box and press Enter or Return, or
- type the full path to the `opcode.xml` file in the Registers folder and press Enter or Return.

The debugger matches your entry with the `opcode.xml` file in the Registers folder. The Register Display in the Register Details window updates its information to show Opcode register details.

The debugger also updates the Register Display to show the current values in the register. If the debugger fails to update the display, an error message appears.

## Register Display

This display shows the current contents of 32 bits of register data, starting at the address that you specify in the **Address** text box. The data appears according to the format that you specify in the **Format** list box.

The Register Display groups the 32 bits of data into register bitfields. Clicking one of the bits selects its associated bitfield. Additional information about the bitfield, such as its name and permissions, appears in the Description portion of the Register Details window.

## Text View

Use this list box to change the information that appears in the Description portion of the Register Details window:

- **Auto**—select to have the IDE determine which information to display in the window
- **Register Description**—select to show information about the entire register, such as the name of the register itself and the meaning of its contents
- **Bitfield Description**—select to show information about the selected bitfield in the [Register Display](#), such as the name of the bitfield and its access permissions
- **Register Details**—select to show in-depth information about the current register, such as its name, its bit values, and bit-value explanations



## **Working with Memory**

*Register Details Window*

---

# Working with Debugger Data

This chapter explains how to work with data that the CodeWarrior™ IDE debugger generates. The following windows show various types of debugger data.

- Symbolics window—shows information that the debugger generates for a program
- Processes window—shows individual processes and tasks that the debugger can control
- Log window—shows messages generated during the debugging session

This chapter contains these sections:

- [Symbolics Window](#)
- [System Browser Window](#)
- [Log Window](#)

## Symbolics Window

The **Symbolics** window displays information that the debugger generates for the active file. Symbolics information includes data about program variables, functions, data structures, and source files.

Specify whether you want browser data generated by the compiler or the language parser, by selecting **Edit > *targetname* Settings...** and selecting the **Build Extras** target settings panel. Select an option from the **Generate Browser Data From** list box. Symbolics information will be generated during the next build or debugging session.

To view the **Symbolics** window, start a CodeWarrior debug session (**Project > Debug** from CodeWarrior menu bar), then select **View > Symbolics**.

[Figure 21.1](#) shows the Symbolics window. [Table 21.1](#) explains items in the window.

## Working with Debugger Data

### Symbolics Window

Figure 21.1 Symbolics Window

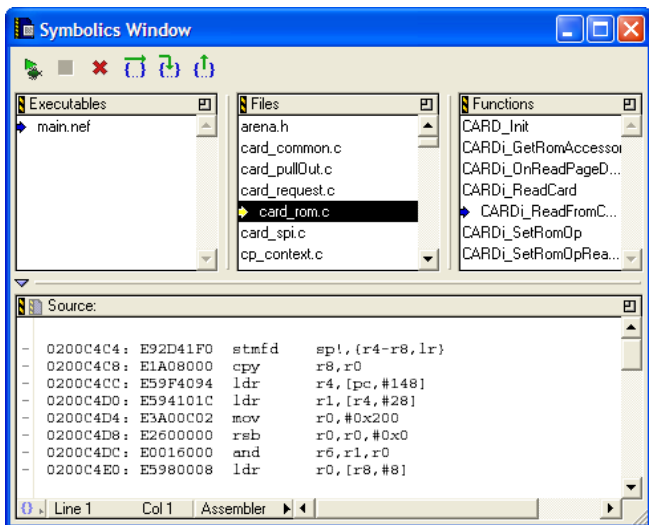

Table 21.1 Symbolics Window Items

Item	Icon	Explanation
Debugger toolbar		Contains buttons that represent common debugging commands, such as stepping through code.
Executables pane		Lists recently used executable files that contain symbolics information.
Files pane		Lists source files in build target being debugged, for selected executable file.
Functions pane		Lists functions declared in the file selected in the Files pane.
Source pane		Displays source code in the file selected in the Files pane.

## Opening the Symbolics Window

The Symbolics window displays information generated by the IDE for a file.



To open the Symbolics window, do one of these tasks:

- Select **View > Symbolics** (Windows) or **Window > Symbolics window** (Linux, Solaris)
- Open a symbolics file. The IDE typically appends `.xSYM` or `.iSYM`, to the names of these files.
- Open an executable file for which the IDE previously generated symbolics information. The IDE typically appends `.exe` or `.app` to these files.



Alternatively, click the Symbolics button (shown at left) in the Thread window toolbar to open the Symbolics window.

---

## Using the Executables Pane

The **Executables** pane lists recently opened executable files for which the IDE generated symbolics information.

To use the pane, select an executable file in the list. The Files pane updates to display information for the selected executable file.

---

## Using the Files Pane

For the selected executable file, the **Files** pane lists the source files in the build target being debugged.

To use the pane, select a file in the list. The Functions pane and Source pane update to display information for the selected file.

---

## Using the Functions Pane

The **Functions** pane lists functions declared in the selected file in the Files pane.

To use the pane, select a function in the list. The Source pane updates to display source code for the selected function.

---

## Using the Source Pane

The **Source** pane displays source code for the selected function in the Functions pane, using the fonts and colors specified in the IDE Preferences window.

To use the pane, select a function in the Functions pane. The corresponding source code appears in the Source pane.

---

## Working with Debugger Data

### System Browser Window

---

If the selected function does not contain source code, the Source pane displays the message **Source text or disassembly not available**.

**NOTE** Use the Source pane in the Symbolics window to view source code, copy source code, and set breakpoints. Use an editor window to modify the source code. Use a Thread window to view the currently executing statement.

## System Browser Window

The **System Browser** window shows system level information about processes executing on various machines, like the host computer or the hardware under debugger control. The window shows this information:

- running processes
- tasks for selected processes
- some hidden processes

[Figure 21.2](#) shows the System Browser window.



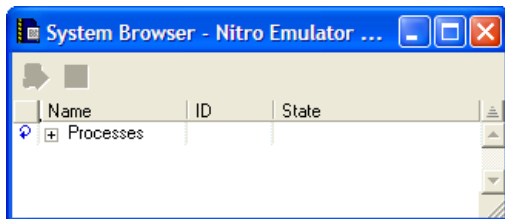

**NOTE** If the System Browser window does not show processes for a specific machine, you must start a debugging session for that machine. For example, you might need to debug a project that runs on external hardware in order to see executing processes for that hardware.

**Figure 21.2 System Browser Window**



Click on the expand icon for a process to view all tasks assigned to the selected process. Processes under debugger control appear in bold. Double-click a task to open it in a new Thread window, or choose the task name and click the Stack Crawl Window button. [Table 21.2](#) explains items in the window.

**Table 21.2 System Browser Window Items**

Item	Icon	Explanation
Attach to Process		Click to have the debugger control the selected process.
Stack Crawl window		Click to open a Thread window for the selected process.
Refresh		This icon indicates that information for selected item is periodically updated. Click this icon to toggle between refresh and no refresh.
No Refresh		This icon indicates that information is not updated for the selected item.
Expand		Click to expand a process and list related tasks.

## Opening the System Browser Window

Use the **System Windows** (Linux/Solaris) or **System** (Windows) menu command to view and manipulate active processes on a selected machine. If multiple machines are available, select each machine from the System Windows submenu to display multiple System Browser windows. If you choose a machine that is already open, the existing window will be brought to the front.

**NOTE** The System Browser window appears on platforms that support it.

[Table 21.3](#) explains how to open the System Browser window.

## Working with Debugger Data

### Log Window

**Table 21.3** Opening the System Browser Window

Menu Bar Layout	Do this...
Windows	Select <b>View &gt; System</b>
Linux/Solaris	Select <b>Window &gt; System Windows</b>

## Attaching Debugger to a Process

Click the **Attach to Process** button to assign a selected process to a new debugging session. This assignment allows the debugger to control processes that it does not otherwise recognize. For example, you can click the Attach to Process button to assign dynamic link libraries or shared libraries to the debugger.

1. Select a process to attach to the debugger.

2. Click Attach to Process



3. Select an executable to attach to the process.

4. Click OK to display the Stack Crawl (Thread) window for the process.

The debugger assumes control of the selected process. Processes under debugger control appear in bold.

## Log Window

The **Log** window displays messages during program execution. Check the **Log System Messages** checkbox in the **Debugger Settings** panel to activate the Log window.

The IDE allows you to save Log window contents to a `.txt` (text) file and copy text from the Log window to the system clipboard.

Windows-hosted Log window messages include:

- Dynamic Link Library (DLL) loading and unloading
- debugging `printf()` messages

[Figure 21.3](#) shows a Windows-hosted Log window.

Figure 21.3 Log Window

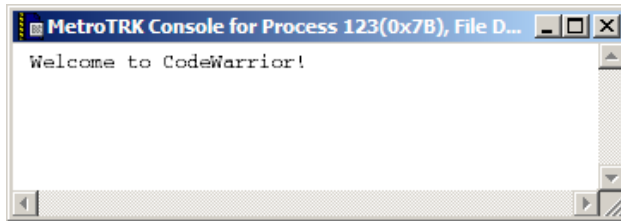

---

## Opening the Log Window

Use the **Debugger Settings** preference panel to enable the message logging option. The Log window records these types of messages for a program during a debugging session:

- the start of new tasks
  - routine entry and exit
  - Windows: DLL loading and unloading, and debug `printf()` messages
1. Select the **Log System Messages** option in the **Debugger Settings** target settings preference panel.
  2. Select **Project > Debug**.

The Log window appears. It allows you to select, copy, and save logged text to a file for later analysis. See the *Targeting* documentation for additional information.



## Working with Debugger Data

*Log Window*

---

# Profiler

---

The CodeWarrior active profiler lets you analyze how processor time is distributed during your program's execution. With this information, you can determine where to concentrate your efforts to optimize your source code most effectively.

This chapter consists of these sections:

- [Overview](#)
- [Using the Profiler](#)
- [Configuring](#)
- [Viewing Results](#)
- [Troubleshooting](#)
- [Reference](#)

## Overview

This section provides you with general information about what a profiler is, different kinds of profilers, and a typical strategy you would follow to measure program performance.

Topics discussed are:

- [What Is a Profiler?](#)—a brief description of profilers and what they do
- [Types of Profilers](#)—different kinds of profilers; their strengths and weaknesses
- [A Profiling Strategy](#)—an outline you should follow when profiling your source code
- [Profiling Source Code](#)—three steps to follow when profiling source code

## What Is a Profiler?

Speed and performance are important issues in most software projects. In most cases, source code that does not work quickly does not work well.

Programmers have regularly observed that 10% of their source code does 90% of the work. Reworking source code to make it more efficient is not a trivial task. You should concentrate on improving that core 10% of your source code first, and improve the infrequently-used source code later, if at all.

How would you like to know precisely where your source code spent its time? That is what a profiler does for you—it gives you clues. More than clues, the CodeWarrior profiler gives you hard and reliable data.

A good profiler analyzes the amount of time your source code spends performing various tasks. Armed with this information, you can apply your efforts to improving the efficiency of core routines.

A profiler can also help you detect bottlenecks—routines your data pass through to get to other places—and routines that are just inordinately slow. Identifying these problems is the first step to solving them.

## Types of Profilers

The simplest profilers count how many times a routine is called. They do not report any information about which routines are called by other routines, or the amount of time spent inside the various routines being profiled.

Clearly a good profile of the runtime performance of a routine requires more information than a raw count. More advanced profilers perform statistical sampling of the runtime environment. These profilers are called passive or sampling profilers.

A passive profiler divides the program being profiled into evenly-sized states in memory. It then samples the processor's program counter at regular intervals to determine which state the counter is in.

The main advantage of a passive profiler is that it requires no modification to the program under observation. You just run the profiler and tell it what program to observe. Also, passive profilers distribute the overhead that they incur evenly over time, allowing the post-processing steps to ignore it. On the other hand, they cannot sample too frequently or the sampling interrupt will overwhelm the program being sampled.

Passive profilers have a significant disadvantage. Although useful, state boundaries do not line up with routine boundaries in the program. This makes it difficult if not impossible to determine which *routines* are heavily used. As a result, passive profilers generate a relatively low-resolution image of what is happening in the program while it runs.

In addition, because passive profilers rely on a statistical sampling technique, the program must run for a long enough period to collect a valid sample. As a result, they do not have good repeatability—that is, the results you get from different runs may vary unless the sampling period is long.

The most advanced and accurate profilers are called active profilers. The CodeWarrior profiler is an active profiler.

An active profiler tracks the precise amount of time a program spends in each individual routine, measured directly from the system clock.

To perform this magic, an active profiler requires that you modify the source code of the program to be observed. An active profiler gains control at every routine entry and exit.



There must be a call to the profiler at the beginning of each profiled routine. The profiler can then track how much time is spent in the routine.

This approach has significant advantages over a passive profiler. An active profiler can report high-resolution results about exactly what your program is doing. An active profiler also tracks the dynamic call tree of a program. This information can be very useful for determining the true cost of calling a routine. The true cost of a routine call is not only the time spent in the routine, it is also the time spent in its children—the subsidiary routines it calls, the routines they call, and continuing to whatever depth is necessary.

Because it uses measurements and not statistical sampling, an active profiler is much more accurate and repeatable than a passive profiler.

The requirement that you must modify the actual source code might seem like a significant disadvantage. With the CodeWarrior profiler, this disadvantage is minimal. Activating the profiler for an entire program—or for a range of routines within a program—is simple.

The compiler does most of the work, inserting the necessary calls to the profiler itself. You do have to recompile the project when you turn on profiling.

Finally, active profilers generate a large amount of raw information. This can lead to confusion and difficulty interpreting the results. The Profiler window that is part of the CodeWarrior profiler system handles these difficulties with ease. You can view and sort the data in whatever way best suits your needs.

## A Profiling Strategy

You use a profiler to measure the runtime performance of your source code. It is important how your source code's performance measures up to some standard. When approaching the problem of measuring performance, you might want to take these three steps:

1. Establish your standards.

For example, you might decide that you want the program to load in less than ten seconds, or check the spelling of a five-page document that contains no misspellings in 15 seconds. Also decide on the platform you will use for testing, since processor speeds vary.

2. Determine how to measure time.

Your measurement device may be no more complicated than a stopwatch, or you may need to add some simple source code to count ticks. At this phase, to test the source code in as close to its finished form as possible, measure time in a way that is accurate enough to suit your needs, and that has the lowest impact on your source code's natural performance. Do not run a full-blown profile here, because profiling can add significant overhead, thus slowing down your source code's raw performance.

3. Run the tests and measure results.

If you meet your performance goals, your job is done. If your source code does not meet your goals, then it is time to profile your source code.

## Profiling Source Code

To profile your source code, you do three things:

1. Run a profiler on the area of the source code you want tested.

This might be a single routine, a group of routines that perform a task, or even the entire application. What you profile depends upon what you are testing.

2. Analyze the data collected by the profiler and improve your source code.

Study the results of your profiling and look for problems and room for improvement. The profiling process is iterative. Repeat these two steps until you achieve the performance gain you need to meet your goals. The rest of this manual discusses how to perform these two steps—profile your source code and analyze the results—using the CodeWarrior profiler system.

3. Retest your source code to verify results

When you are satisfied that you have reached your goals, you have one more step to perform. Run your original tests—without the profiler of course—to verify that your source code in its natural state meets your performance goals. The CodeWarrior profiler will help you meet those goals quickly and easily.

## Using the Profiler

The CodeWarrior profiler lets you analyze how processor time is distributed during your program's execution. With this information, you can determine where to concentrate the efforts to optimize the source code most effectively.

This section discusses the following principal topics:

- [What It Does](#)—an overview of the principle features of the profiler
- [How It Works](#)—basic information on the elements of the profiler and about how to use the profiler in your source code
- [Profiling Made Easy](#)—a step-by-step guide to using the profiler

## What It Does

The CodeWarrior profiler is an interactive analytical tool that can profile C or C++ source code. For every project, from the simplest to the most complex, the profiler offers many useful features that help you analyze your source code. You can:

- turn the profiler on and off at compile time
- profile any routine, group of routines, or an entire project
- track time spent in any routine
- track time spent in a routine and the routines it calls—its children

- track execution paths and times in a dynamic call tree
- collect detailed or summary data in a profile
- use precision time resolutions for accurate profiling
- track the stack space used by each routine

## How It Works

The CodeWarrior profiler is an active profiler. The profiling system consists of three main profiler components:

- a statically-linked code library of compiled code containing the profiler
- an Application Programming Interface (API) to control the profiler
- the **Profiler** window to view and analyze the profile results

Details of the API are discussed in [Profiler Function Reference](#). The **Profiler** window is discussed in [Viewing Results](#).

The rest of this section will discuss the general profiling process. Subsequent sections describe how to carry out the profiling process for your particular target.

To use the profiler, do the following:

- Include the correct profiler library and files in your CodeWarrior project
- Modify your source code to make use of the profiler API
- Use the API to initialize the profiler, to dump the results into a file, and to exit the profiler
- Use the **Profiler** window to view the results

You can profile an entire program or, by adding compiler directives to your source code, you can profile any individual section of your program.

Modify the original source code slightly to initialize the profiler, dump results, and exit the profiler when through. Also, you may modify the source code more extensively to profile individual portions of your source code.

Then the compiler and linker—using a profiler library—generate a new version of your program, ready for profiling. While it runs, the profiler generates data. Usually, your program will run slightly more slowly because of the profiler overhead, but that is taken into account in the final results. When complete, use the **Profiler** window to analyze the data and determine what changes are appropriate to improve performance. You can repeat the process as often as desired until you have turned your source code into a fast and efficient system.

### See also

[Profiler Function Reference](#) and [Viewing Results](#)

## Profiling Made Easy

This section takes you step by step through the general process of profiling an application.

To profile an application, you:

1. [Add a profiler library to the project](#)
2. [Turn on profiling](#)
3. [Include the profiler API interface](#)
4. [Initialize the profiler](#)
5. [Dump the profile results](#)
6. [Exit the profiler](#)

In the steps that follow, we detail precisely what to do in both C and C++. These steps may seem a little complicated. Do not be alarmed. Using the CodeWarrior profiler is actually easier than reading about how to do it.

1. Add a profiler library to the project

The source code that performs the profiler magic has been compiled into libraries. The precise library that you add to your source code depends on the target for which you are profiling source code and on the kind of source code you are developing.

2. Turn on profiling

You can use the following methods to turn profiling on or off:

- a. Project-Level Profiling

To turn on profiling for an entire project, use the project settings. In the **Project Settings** dialog, choose the processor you are generating compiled code for under the Code Generation option. Select the **Profiler Information** checkbox, as shown in [Figure 22.1](#). With profiling on, the compiler generates all the code necessary so that every routine calls the profiler.

**Figure 22.1 Processor Preferences Options for PowerPC**

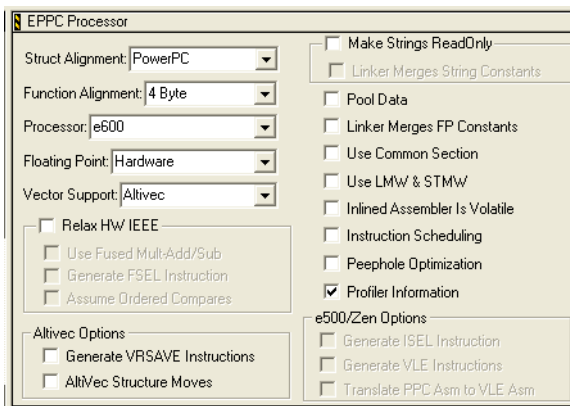

**b. Routine-Level Profiling**

To profile certain routines (rather than the entire project), use the appropriate profiler API calls for your target to initialize the profiler, set up profiling, and immediately turn profiling off. You can then manually turn profiling on and off by placing profiler calls around the routine or routines you want to profile. For example, you could modify your source code to look like [Listing 22.1](#).

**Listing 22.1 Profiling a Routine**

```
void main()
{
    ...
    err = ProfilerInit(...);

    if (err == noErr)
    {
        ProfilerSetStatus(FALSE); // turn off profiling until needed
        // more source code....

        // now you reach routine you want to profile
        ProfilerSetStatus(TRUE); // turn on profiling
        foobar();                // this routine is profiled
                                // and shows up in viewer
        ProfilerSetStatus(FALSE); // turn profiling off again

        // more source code....
        ProfilerTerm();
    }
}
```

## Profiler

### Using the Profiler

---

```
}
```

---

Assuming that profiling is on for an entire project, you can turn off profiling at any time. First, use an appropriate call to turn off profiling. Then use another call to turn it on. Turn it on just before calling the routine or routines you are interested in. Turn it off when those routines return.

Alternatively, you can use `#pragma` statements in C and C++. These are not as useful as using profiler API calls. For example, suppose you have two routines—`foo()` and `bar()`—that each call a third utility routine, `barsoom()`. If you use compiler directives to turn on profiling for `foo()` and `barsoom()`, the result you get will include the time for `barsoom()` when called from `bar()` as well.

#### 3. Include the profiler API interface

To use the profiler, add at least three profiler-related calls to your source code. These calls are detailed in the next three steps. The process varies slightly for the different languages and targets.

Source files that make calls to the profiler API must include the appropriate header file for your target. For example, to profile an entire application, you would add this line of source code to the file that includes your `main()` function:

```
#include <profiler.h>
```

---

**TIP** You do not have to include the header file in every file that contains a profiled function, only in those that actually make direct profiler API calls.

---

#### 4. Initialize the profiler

At the beginning of your source code, call the appropriate function for your target. See [Profiler Function Reference](#) to find out the precise function name that you need for a specific target.

#### 5. Dump the profile results

Obviously, if you profile source code you want to see the results. The profiler dumps the results to a data file. The data is in a proprietary format understood by the profiler.

#### 6. Exit the profiler

When you are finished with the profiler, before exiting the program you should terminate the profiler by calling the correct profiler API function.

On most platforms, if you initialize the profiler and then exit the program without terminating the profiler, timers may be left running that could crash the machine.

The call to terminate the profiler stops the profiler and deallocates memory. It does not dump any information. Any collected data that has not been dumped is lost when you call the function to terminate the profiler.

Having performed these quick steps, you simply compile your program and run it. The IDE automatically opens this file in the Profiler window when the dump is complete. You can later re-open the file in the IDE to view the info again.

In summary, the process of using the CodeWarrior profiler is quite easy. You add the requisite library, turn on profiling, include the header file, initialize the profiler, dump the results, and exit. It is a remarkably painless and simple process that quickly gets you all the data you need to perform a professional-level analysis of your application's runtime behavior.

## Configuring

This reference section discusses how to use the profiler libraries, APIs, and compiler options.

The sections in this section are:

- [Profiler Libraries and Interface Files](#)—the libraries and interface files that you add to your source code in order to use the profiler
- [Profiling Special Cases](#)—special cases to consider when profiling source code

### Profiler Libraries and Interface Files

You can find all of the profiler libraries and interface files in the Profiler folder. The profiling source code that actually keeps track of the time spent in a routine exists in a series of libraries. Depending upon the nature of your project and the platform for which you are writing source code, you link in one or another of these libraries as appropriate. The libraries you use must match your settings in the *Target* settings panel.

The `profiler.h` file is the header file for the profiler API for C and C++. Include this file to make calls to control the profiler

## Profiling Special Cases

The profiler handles recursive and mutually recursive calls transparently. The profiler also warns you when profiling information was lost because of insufficient memory. (The profiler uses memory buffers to store profiling data.)

For leading-edge programmers, the profiler transparently handles and reliably reports the times for abnormally terminated routines exited through the C++ exception handling model (try, throw, catch) or the ANSI C library `setjmp()` and `longjmp()` routines.

This section describes special cases you may encounter while profiling your source code:

- [Profiling Source Code with #pragma Statements](#)
- [Initializing Profiler with ProfilerInit\(\)](#)
- [Terminating Profiler with ProfilerDump\(\)](#)
- [Profiling Abnormally Terminated Functions](#)
- [Debugging Profiled Source Code](#)

## Profiling Source Code with #pragma Statements

You can substitute `#pragma` statements for profiler API function calls to profile your C/C++ source code on the function level. However, this is not as useful as the profiler calls. See [Routine-Level Profiling](#) for more information.

Setting the “Generate Profiler Calls” Processor preference option sets a preprocessor variable named `__profile__` to 1. If profiling is off, the value is zero. You can use this value at compile time to test whether profiling is on.

---

**NOTE** The option “Generate Profiler Calls” may vary with different targets. For example, for some targets this option is displayed as “Generate Code for Profiling” in the **Code Generation > Processor** target settings panel. For more information about the option, see the *CodeWarrior Build Tool Reference*.

---

Instead of, or in addition to, setting the option in the Processor preferences, you can turn on profiling at compile time. The C/C++ compiler supports three preprocessor directives that you can use to turn compiling on and off at will.

<code>#pragma profile on</code>	enables calls to the profiler in functions that are declared following the pragma
<code>#pragma profile off</code>	disables calls to the profiler in functions that are declared following the pragma
<code>#pragma profile reset</code>	sets the profile setting to the value selected in the preferences panel



You can use these directives to turn profiling on for any functions you want to profile, regardless of the settings in the Processor preferences. You can also turn off profiling for any function you do not want to profile.

## Initializing Profiler with ProfilerInit()

At the beginning of your source code, call `ProfilerInit()` to initialize the profiler. [Table 22.1](#) shows the prototypes for `ProfilerInit()` for C/C++.

**Table 22.1 ProfilerInit() Prototypes**

C/C++	<pre>long ProfilerInit(     ProfilerCollectionMethod method,     ProfilerTimeBase timeBase,     short numFunctions, short     stackDepth);</pre>
-------	--

The parameters tell the profiler how this collection run is going to operate, and how much memory the profiler should allocate for its data buffers. Each parameter and its purpose is given in [Table 22.2](#).

**Table 22.2 ProfilerInit() Parameters**

Parameter	Purpose
<code>method</code>	collect detailed or summary data
<code>timeBase</code>	time scale to use in measurements
<code>numFunctions</code>	maximum number of routines to profile
<code>stackDepth</code>	approximate maximum depth of deepest calling tree

The collection method may be either `collectDetailed` or `collectSummary`. If you collect detailed data, you get information for the calling tree—the time in each routine and each of its children in the calling hierarchy. Summary data collects data for the time spent in each routine without regard to the calling chain. Collecting detailed data requires more memory.

The `timeBase` may be one of the following values:

- `ticksTimeBase`
- `microsecondsTimeBase`

## Profiler

### Configuring

---

- `timeMgrTimeBase`
- `PPCTimeBase`
- `win32TimeBase`
- `bestTimeBase`

The `bestTimeBase` option automatically selects the most precise timing mechanism available on the computer running the profiled software. Not all of these values are supported on all target platforms. Refer to the Targeting Manual for your product to determine which time bases are available for use.

The `numFunctions` parameter is the approximate number of routines to be profiled. The `stackDepth` parameter is the approximate maximum depth of your calling chain. You do not need to know the precise values ahead of time. If the profiler runs out of memory to hold data in its buffers, the profiler loses some data but notifies you of this in the results. You can then modify the parameters in the call to `ProfilerInit()` to increase the buffers and preserve all your data.

The profiler allocates buffers in the profiled application's heap based on the method of collection, the number of routines, and the depth of the calling tree. On platforms where it is possible, the profiler will allocate memory outside of the application's heap, which helps reduce the profiler's effect on the application.

The call to `ProfilerInit()` returns a non-zero error value if the call fails for any reason. Use the return value to ensure that memory was allocated successfully before continuing with the profiler. Typically you would add this call as conditionally compiled code so that it compiles and runs only if profiling is on and the call to `ProfilerInit()` was successful.

You call `ProfilerInit()` before any profiling occurs. Typically you make the call at the beginning of your source code.

See also [Time and Timebases](#) and [Memory Usage](#).

## Calling ProfilerInit() in C/C++

In C/C++, the function call would be at the beginning of the `main()` function.

The function call might look like this:

---

```
if (!ProfilerInit(collectDetailed, bestTimeBase, 20, 5))
{
// your profiled source code
}
```

---

Of course, your parameters may vary depending upon how many routines you have and the depth of your calling chains.

## Terminating Profiler with ProfilerDump()

The profiler dumps its data to a file when you call `ProfilerDump()`. The file appears in the current default directory, usually the project directory.

You provide a file name when you call `ProfilerDump()`. You may dump results as often as you like. You can provide a different file name for intermediate results (if you have multiple calls to `ProfilerDump()`), or use the same name. If the specified file already exists, a new file is created with an incrementing number appended to the file name for each new file. This allows the dump to be called inside a loop with a constant file name. This can be useful for dumping intermediate results on a long task.

`ProfilerDump()` does not clear accumulating results. If you want to clear results you can call `ProfilerClear()`.

A typical call to `ProfilerDump()` would be placed just before you exit your program, or at the end of the source code you are profiling. The prototypes for `ProfilerDump()` are listed in [Table 22.3](#).

**Table 22.3 ProfilerDump() Prototypes**

C/C++	<code>long ProfilerDump(unsigned char *filename);</code>
-------	--

### Calling ProfilerDump()

There is only one parameter: `char*`. The parameter points to a C-style string for `filename`. The IDE automatically adds a `.cwp` extension to the file name.

## Profiling Abnormally Terminated Functions

The profiler correctly reports data for abnormally terminated functions that exited through the C++ exception handling model (`try`, `throw`, `catch`) or the ANSI C library `setjmp()` and `longjmp()` routines. You do not have to do anything to get this feature, as it is automatic and part of the profiler's design.

However, there is a possibility of some errors in the reported results for an abnormally terminated function.

First, the profiler does not detect the abnormal termination until the next profiling call after the abnormal termination. Therefore, some additional time will be reported as belonging to the terminated function.

Second, if the next profiler event is a profiler entry and the new stack frame for that function is larger than the frames that were abnormally exited, the profiler will not immediately detect that the original function was abnormally terminated. In that case the profiler will treat the function just entered as a child of the function abnormally terminated. The profiler will correct itself on the next profiling event without this

property—that is, when the stack returns to a point smaller than it was when the abnormally terminated function exited.

Finally, remember that the profiler is not closed properly and the output file is not dumped when `exit()` is called. If you need to call `exit()` in the middle of your program and want the profiler output, call `ProfilerDump()`.

If you are using the profiler, you should always call `ProfilerTerm()` before `exit()`.

---

**CAUTION** If a program exits after calling `ProfilerInit()` without calling `ProfilerTerm()`, timers may be left running that could crash the machine.

---

## Debugging Profiled Source Code

It is possible to debug source code that has calls to the profiler in it. Because, the profiler interferes with stepping through source code, you may find it simpler to debug non-profiled source code and profile separately. What happens when you step into and out of a profiled routine is described in this section. Also, the effects that stopping in the debugger has on the profile results are described.

### Stepping into a Profiled Routine

If you step into a profiled routine you may see assembly code instead of source code. The compiler has added calls to `__PROFILE_ENTRY` at the start of the routine. This is how the profiler knows when to start counting time for the routine.

If you step through the assembly code far enough to get to the code derived from the original source code, then switch the view from source to assembly and back again, you can see the original source code.

### Stepping out of a Profiled Routine

If you single-step out of a routine being profiled, you may end up in the `__PROFILE_EXIT` assembly code from the profiler library. This is how the profiler knows when to stop counting time for the routine.

### Effect of Stopping on Profile Results

If you stop in a profiled routine, the profiler counts all the time you spend in the debugger as time that routine was running. This skews the results.

---

**CAUTION** If you debug profiled source code, you should not to kill the program from the debugger. If you have called `ProfilerInit()` you should call

---

ProfilerTerm() on exit. If you do not do so, you may crash your system.

---

## Viewing Results

This section explains the ways you may view profile data. You will look at:

- [What It Does](#)—the principal features of the profiler
- [How It Works](#)—the profiler interface and how you can view data
- [Finding Performance Problems](#)—use the profiler to locate problems

### What It Does

The **Profiler** window displays profiler output for you to analyze the results of your program's execution. The profiler reads the dump files created by the calls in your source code and displays the data in a form that you can use. Using the data display you can:

- sort data by any of several relevant criteria such as name, time in routine, and percent of time in routine
- open multiple profiles simultaneously to compare different versions of the profiled source code
- identify trouble spots in the source code
- view summary, detailed, or object-based data

### How It Works

Open profile data files exactly as you open files in any application. Use the **Open** command from the **File** menu or drop the data file's icon on the CodeWarrior IDE. Whatever approach you take, when you open a file, a window appears.

### Profiler Window

The **Profiler** window allows you to view several elements of the profile data simultaneously, as shown in [Figure 22.2](#).

**Figure 22.2 Profiler Window**

Collection Method	Timebase	Time/Date created	Overhead (ms)			
<b>ExamplePPC.prof</b>						
Method: Detailed Timebase: PowerPC Saved at: 11:32:18 5/23/97 Overhead: 0.504						
Function Name	Count	Only	%	+Children	%	Average
test	1	0.032	0.0	2492.671	100.0	0.032
test2	15	1245.542	50.0	2492.639	100.0	83.036
test3	15	1246.902	50.0	1246.981	50.0	83.127
test4	30	0.195	0.0	0.195	0.0	0.007

## Profiler Window Data Columns

The **Profiler** window contains a series of columns containing data from the profile. All times are displayed according to the resolution of the timer that you use to profile data. The results in the window are only as precise as the timer used.

The times shown in the data columns are relative. Each time datum is reported to three decimal places. However, some timebases (most notably `ticksTimeBase`) are less precise. See [Time and Timebases](#).

[Table 22.4](#) lists each of the columns in the profiler window (from left to right) and the information that column contains.

**Table 22.4 Profile Window Data Columns**

Column	Contents
Function name	Routine name. (The profiler unmangles C++ function names.)
Count	Number of times this routine was called.
Time	Time spent in this routine, not counting time in routines that this routine calls.
%	Percent of total time for the Time column.
+Children	Time spent in this routine and all the routines it calls.
%	Percent of total time for the +Children column.
Average	Average time for each routine invocation: Time divided by the number of times the routine was called.
Maximum	Longest time for an invocation of the routine.
Minimum	Shortest time for an invocation of the routine.

## Sorting Data

You can view the data sorted by the value in any column. To change the sort order, click the column title. The heading becomes highlighted and data is sorted by the value in that column. Use the arrow control to change the direction of the sort (ascending/descending).

## Multiple Windows

You can open any number of different **Profile** windows simultaneously. This allows you to compare the results of different runs easily.

## Window Views

In the tabs, you may choose to view the data in one of three ways: flat, detail, or class. Not all possibilities are available for all profiles.

### Flat View

The **Flat** view displays a complete, non-hierarchical, flat list of each routine profiled. No matter what calling path was used to reach a routine, the profiler combines all the data for the same routine and displays it on a single line. [Figure 22.3](#) shows a **Flat** view.

**Figure 22.3 Flat View**

Function	Count	Time	%	+Children	%	Average	Maximum	Minimum	Stack Space
CAppearanceApp::CAppearanceApp()	1	0.1	0.0	31.5	0.2	0.1	0.1	0.1	0
CAppearanceApp::FindCommandStatus(long,unsigned ...	154	0.1	0.0	0.4	0.0	0.0	0.0	0.0	0
CAppearanceApp::DbeyCommand(long,void*)	2	0.0	0.0	93.9	0.5	0.0	0.0	0.0	0
CAppearanceApp::RegisterClasses()	1	0.0	0.0	1.8	0.0	0.0	0.0	0.0	0
CAppearanceApp::StartUp()	1	0.0	0.0	45.2	0.2	0.0	0.0	0.0	0
CustomControlColorProc	338	1.8	0.0	26.9	0.1	0.0	0.0	0.0	0
InitializeHeap(short)	1	0.0	0.0	0.0	0.0	0.0	0.0	0.0	0
LAMControllmp::ActivateSelf()	27	0.7	0.0	1.7	0.0	0.0	0.0	0.0	0
LAMControllmp::ApplyForeAndBackColors() const	142	12.7	0.2	14.1	0.1	0.1	0.3	0.1	0
LAMControllmp::ApplyTextColor(short,bool,bool)	12	0.1	0.0	0.4	0.0	0.0	0.0	0.0	0
LAMControllmp::DeactivateSelf()	18	0.7	0.0	1.4	0.0	0.0	0.1	0.0	0
LAMControllmp::DrawSelf()	26	575.6	9.9	577.4	3.2	22.1	327.3	0.6	0
LAMControllmp::EnableSelf()	18	0.0	0.0	0.0	0.0	0.0	0.0	0.0	0

The **Flat** view is particularly useful for comparing routines to see which take the longest time to execute. The **Flat** view is also useful for finding a performance problem with a small routine that is called from many different places in the program. This view helps you look for the routines that make heavy demands in time or raw number of calls.

A **Flat** view window can be displayed for any profile.

### Detail View

The **Detail** view displays routines according to the dynamic call tree, as [Figure 22.4](#) shows.



**Figure 22.4 Detail View**

Function	Count	Time	%	+ Children	%	Average	Maximum	Minimum	Stack Space
InitializeHeap(short)	1	0.0	0.0	0.0	0.0	0.0	0.0	0.0	0
UQDGlobals::InitializeToolbox()	1	0.0	0.0	0.0	0.0	0.0	0.0	0.0	0
LGrowZone::LGrowZone(long)	1	0.1	0.0	0.2	0.0	0.1	0.1	0.1	0
TestFunction()	1	0.0	0.0	0.0	0.0	0.0	0.0	0.0	0
TestFunction2()	1	0.0	0.0	0.0	0.0	0.0	0.0	0.0	0
TestFunction3()	1	0.0	0.0	0.0	0.0	0.0	0.0	0.0	0
CAppearanceApp::CAppearanceApp()	1	0.1	0.0	31.5	0.5	0.1	0.1	0.1	0
LApplication::Run()	1	0.2	0.0	5801.5	99.5	0.2	0.2	0.2	0

Routines that are called by a given routine are shown indented under that routine. This means that a routine may appear more than once in the profile if it called from different routines. This makes it difficult to tell how much total time was spent in a routine. However, you can use the **Flat** view for that purpose.

The **Detail** view is useful for detecting design problems in source code; it lets you see what routines are called how often from what other routines. Armed with knowledge of your source code's underlying design, you may discover flow-control problems.

For example, you can use **Detail** view to discover routines that are called from only one place in your source code. You might decide to fold that routine's source code into the caller, thereby eliminating the routine call overhead entirely. If it turns out that the little routine is called thousands of times, you can gain a significant performance boost.

In **Detail** view, sorting is limited to routines at the same level in the hierarchy. For example, if you sort by routine name, the routines at the top of the hierarchy will be sorted alphabetically. For each of those first-level routines, its second-level routines will be sorted alphabetically underneath it, and so on.

The **Detail** view requires that `collectDetailed` be passed to `ProfilerInit()` when collecting the profile. If `collectSummary` is used, you cannot display the data in **Detail** view.

## Class View

The **Class** view displays summary information sorted by class. Beneath each class the methods are listed. This is a two-level hierarchy. You can open and close a class to show or hide its methods, just like you can in the detail view.

When sorting in **Class** view, functions stay with their class, just like subsidiary functions in detail view stay in their hierarchical position. [Figure 22.5](#) shows the methods sorted by count.

**Class** view allows you to study the performance impact of substituting one implementation of a class for another. You can run profiles on the two implementations, and view the behavior of the different objects side by side. You can do the same with the **Flat** view on a routine-by-routine basis, but the class view gives you a more natural way of accessing object-based data. It also allows you to gather all the object methods together

## Profiler

### Viewing Results

and view them simultaneously, revealing the effect of interactions between the object's methods.

**Figure 22.5 Class View**

Function	Count	Time	%	+ Children	%	Average	Maximum	Minimum	Stack Space
TestFunction()	1	0.0	0.0	0.0	0.0	0.0	0.0	0.0	0
TestFunction2()	1	0.0	0.0	0.0	0.0	0.0	0.0	0.0	0
InitializeHeap(short)	1	0.0	0.0	0.0	0.0	0.0	0.0	0.0	0
TestFunction3()	1	0.0	0.0	0.0	0.0	0.0	0.0	0.0	0
SiControlActionUpp::	1	0.0	0.0	0.0	0.0	0.0	0.0	0.0	0
LChasingArrows::	2	0.0	0.0	1.0	0.0	0.0	0.0	0.0	0
TRegistrar<LSlider>::	2	0.0	0.0	1.5	0.0	0.0	0.0	0.0	0
ReanimateObjects<?LWindow>__11UReanimatorFuls_...	2	0.0	0.0	43.1	0.7	0.0	0.0	0.0	0
TRegistrar<LProgressBar>::	2	0.0	0.0	1.8	0.0	0.0	0.0	0.0	0
TRegistrar<LSeparatorLine>::	2	0.0	0.0	1.0	0.0	0.0	0.0	0.0	0
TRegistrar<LAmWindowHeaderImp>::	2	0.0	0.0	0.0	0.0	0.0	0.0	0.0	0
LSeparatorLine::	2	0.0	0.0	0.9	0.0	0.0	0.0	0.0	0
SiUnhiltMenu::	2	70.3	1.2	70.3	1.2	35.1	70.3	0.0	0
TRegistrar<LWindowHeader>::	2	0.0	0.0	2.7	0.0	0.0	0.0	0.0	0
TRegistrar<LWindowThemeAttachment>::	2	0.0	0.0	0.1	0.0	0.0	0.0	0.0	0
TRegistrar<LChasingArrows>::	2	0.0	0.0	1.0	0.0	0.0	0.0	0.0	0
UAEDesc::	2	0.1	0.0	0.3	0.0	0.1	0.1	0.0	0
TRegistrar<LWindow>::	2	0.0	0.0	27.9	0.5	0.0	0.0	0.0	0
LComparator::	2	0.0	0.0	0.0	0.0	0.0	0.0	0.0	0
UAppleEventsMgr::	3	0.8	0.0	1.1	0.0	0.3	0.6	0.1	0
UControlRegistry::	4	0.1	0.0	3.4	0.1	0.0	0.0	0.0	0

Object view displays *N/A* (Not Available) in the +Children column for classes in a collectSummary profile. This is because the detail information is missing from the file.

The **Class** view requires that the profile contain at least one mangled C++ name. If there is none, you cannot use object view.

## Finding Performance Problems

As you work with the profiler, you will see that the information provided quickly guides you to problem areas.

To look for heavy time use, sort the view by either the Time column or the +Children column. Then examine routines that appear near the top of the list. These are the routines that use the greatest percentage of your source code's time. Any improvement in these routines will be greatly magnified in your source code's final performance.

You may also want to sort based on the number of times a routine is called. The time you save in a heavily-used routine is saved each time it is called.

If stack size is a concern in your source code, you can sort based on the Stack Space column. This lets you see the largest size the stack reached during the profile.

---

# Troubleshooting

This section answers common questions about the profiler. So if you have a problem with the profiler, consult this section first. Other users may have encountered similar difficulties, and there may be a simple solution.

---

## Profile Times Vary Between Runs

“I’m getting different results (within 10%) in the profiler every time I run my program.”

### Background

There are two potential reasons that this may be happening. Both are time-related problems. The first problem that can occur is inadequate time in the function relative to the profiler resolution. The second problem is clock resonance.

### Inadequate Time in the Function

If the function time that you are trying to measure is only 10 times greater than the resolution of the timebase, you will encounter this problem.

### Solution

To solve this problem, increase the number of times your function is called, then the average the profiler computes will be more accurate.

Sometimes it is helpful to pull a routine out of a program, and into a special test program which calls it many times in a loop for performance tuning purposes. However, this technique is susceptible to cache differences between the test and real program.

### Clock Resonance

If the operations you are performing in your profiled source code coincide with the incrementing of the profiler clock, the results can be distorted, and could show wild variations.

### Solution

Avoid this problem by increasing the number of times your function is called.

## Problems while Profiling Inline Functions

“My inline functions are not getting inlined when I’m profiling my source code. What’s happening?”

### Background

When the compiler switch for profiling is turned on, the default setting for “don’t inline functions” is changed to true. This is so that these functions will have profiling information collected for them.

### Solution

Place a `#pragma dont_inline off` in your source file to turn on function inlining again. You will not collect profile information for inline functions. In effect, a function can be inlined or profiled, but not both. The profiler cannot profile an inlined function.

---

**TIP** If you use the `#pragma dont_inline off` in your source code, you may see profile results for some inline functions. When you declare an inline function, the compiler is allowed, but not required to inline the function. It is allowable for the compiler to inline some functions, but not others. Data is collected only for the calls that were not inlined. The calls that were inlined have their time added into the time of the calling function.

---

## Profiling Library Could not be Found

“While trying to profile my dynamically linked library (shared library), I get an error message saying that the profiling library could not be found.”

### Background

This problem occurs when trying to use the profiling library to profile your dynamically linked library (DLL) and the profiling library is not in the search path.

### Solution

Add the profiling library to the search path.

---

## Reference

This section contains the detailed technical reference information you may need when using the profiler.

The topics discussed include:

- [Compiler Directives](#)—handling compiler directives
- [Memory Usage](#)—understanding memory usage
- [Time and Timebases](#)—the available time resolutions
- [Profiler Function Reference](#)—a reference for all of the profiler API functions

## Compiler Directives

You can control routine-level profiling using compiler directives.

The C/C++ compiler supports three preprocessor directives that you can use to turn compiling on and off at will.

<code>#pragma profile on</code>	Enables calls to the profiler in functions that are declared following the pragma.
<code>#pragma profile off</code>	Disables calls to the profiler in functions that are declared following the pragma.
<code>#pragma profile reset</code>	Sets the profile setting to the value selected in the preferences panel.

You can use these directives to turn profiling on for any functions you want to profile, regardless of the settings in the Processor preferences. You can also turn off profiling for any function you do not want to profile.

As there are compiler directives to turn the profiler on and off, there are also directives to test if the profiler is on. You can use these tests in your source code so that you can run your program with or without the profiler and not have to modify your source code each time.

## Profiler

### Reference

---

In C/C++, use the `#if-#endif` clause. For example:

---

```
void main()
{
#if __profile__ // is the profiler on?
    if (!ProfilerInit(collectDetailed, bestTimeBase, 20, 5))
    {
#endif
        test(15);
#if __profile__
        ProfilerDump("Example.prof");
        ProfilerTerm();
    }
#endif
}
```

---

See also [Routine-Level Profiling](#)

## Memory Usage

The profiler allocates two buffers in your program's heap to hold data as it collects information about your source code: one based on the number of routines, and one based on the stack depth. You pass these parameters in your call to `ProfilerInit()`.

When possible, the profiler will allocate its memory outside of your program's heap to reduce the impact of the profiler on your program. If this is not possible, the profiler's memory buffers will be allocated in your program's default heap. You must ensure that the heap is large enough to hold both your program's dynamically allocated data and the profiler's buffers.

In summary collection mode, the profiler allocates  $64 \text{ bytes} * \text{numFunctions}$  and  $40 \text{ bytes} * \text{stackDepth}$ .

In detailed collection mode, the profiler allocates  $12 * 64 * \text{numFunctions}$  bytes and  $40 * \text{stackDepth}$  bytes.

As an example, assume `numFunctions` is set to 100, and `stackDepth` to 10. In summary mode the profiler allocates buffers of 6,400 bytes and 400 bytes. In detailed mode it allocates buffers of 76,800 bytes and 400 bytes.

`ProfilerGetDataSizes()` lets you query the profiler for the current size of the data collected in the function and stack tables. This information can be used to tune the parameters passed to `ProfilerInit()`.

## Time and Timebases

The `timeBase` may be one of the following values:

- `ticksTimeBase`
- `microsecondsTimeBase`
- `timeMgrTimeBase`
- `PPCTimeBase`
- `win32TimeBase`
- `bestTimeBase`

The `bestTimeBase` option automatically selects the most precise timing mechanism available on the computer running the profiled software. Not all of these values are supported on all target platforms. Refer to the Targeting Manual for your product to determine which timebases are available for use.

When you call `ProfilerInit()`, the constant `bestTimeBase` tells the profiler to figure out the most precise timebase available on your platform and to use it.

## Profiler Function Reference

This is a reference for all profiler functions mentioned in the text of this manual. The functions described in this section are:

- [ProfilerInit\(\)](#)
- [ProfilerTerm\(\)](#)
- [ProfilerSetStatus\(\)](#)
- [ProfilerGetStatus\(\)](#)
- [ProfilerGetDataSizes\(\)](#)
- [ProfilerDump\(\)](#)
- [ProfilerClear\(\)](#)

The discussion of each function includes the following attributes:

- Description: A high-level description of the function
- Prototypes: The entire C/C++ prototypes for the function
- Remarks: Implementational or other notes about the function

## ProfilerInit()

`ProfilerInit()` prepares the profiler for use and turns the profiler on. The parameters tell the profiler how this collection run is going to operate, and how much memory to allocate. `ProfilerInit()` *must* be the first profiler call before you can call any other routine in the profiler API. A call to `ProfilerInit()` must be followed by a matching call to `ProfilerTerm()`.

### Prototypes

```
typedef enum {
    collectDetailed,
    collectSummary
} ProfilerCollectionMethod;

typedef enum {
    bestTimeBase
} ProfilerTimeBase;

long ProfilerInit(
    ProfilerCollectionMethod method,
    ProfilerTimeBase bestTimeBase,
    long numFunctions, short stackDepth);
```

### Remarks

`ProfilerInit()` will allocate its memory outside of your program's heap to reduce the impact of the profiler on your program. If this is not possible, the profiler's memory buffers will be allocated in your program's default heap. You must ensure that the heap is large enough to hold both your program's dynamically allocated data and the profiler's buffers.

`ProfilerInit()` returns an error status that indicates whether or not the profiler was able to allocate its memory buffers. If the return value is 0, then memory allocation was successful. If a non-zero value is returned, then the allocation was not successful.

The `method` and `timeBase` parameters select the appropriate profiler options. The `numFunctions` parameter indicates the number of routines in the program for which the profiler should allocate buffer storage. If the profiler is operating in detailed mode, this number is internally increased (exponentially), because of the branching factors involved. The `stackDepth` parameter indicates how many routines deep the stack can get.



## ProfilerTerm()

`ProfilerTerm()` stops the profiler and deallocates the profiler's buffers. It calls `ProfilerDump()` to dump out any information that has not been dumped. `ProfilerTerm()` must be called at the end of a profile session.

```
void ProfilerTerm( void );
```

### Remarks

If a program exits after calling `ProfilerInit()` you should call `ProfilerTerm()`. Failing to do so may lead to a crash on some platforms.

---

## ProfilerSetStatus()

`ProfilerSetStatus()` lets you turn profiler recording on and off in the program. This makes it possible to profile specific sections of your source code such as a screen redraw or a calculation engine. The profiler output makes more sense if the profiler is turned on and off in the same routine, rather than in different routines.

```
void ProfilerSetStatus( short on );
```

### Remarks

This routine and `ProfilerGetStatus()` are the only profiler routines that may be called at interrupt time.

Pass 1 to turn recording on and 0 to turn recording off.

## ProfilerGetStatus()

`ProfilerGetStatus()` lets you query the profiler to determine if it is collecting profile information.

```
short ProfilerGetStatus( void );
```

### Remarks

This routine and `ProfilerSetStatus()` are the only profiler routines that may be called at interrupt time.

`ProfilerGetStatus()` returns a 1 if the profiler is currently recording, 0 if it is not.

---

## ProfilerGetDataSizes()

`ProfilerGetDataSizes()` lets you query the profiler for the current size of the data collected in the function and stack tables. This information can be used to tune the parameters passed to `ProfilerInit()`.

### Prototypes

```
void ProfilerGetDataSizes(  
    long *functionSize,  
    long *stackSize);
```

### Remarks

If you have passed `collectDetailed` to `ProfilerInit()`, `ProfilerGetDataSizes()` returns the number of actual routines in the table, which may be larger than the value passed to `ProfilerInit()` in `numFunctions`. This is because the profiler multiplies `numFunctions` by 12 when it allocates the table. The multiplication is done so that you can easily switch between `collectDetailed` and `collectSummary` methods without changing the parameters.

---

## ProfilerDump()

ProfilerDump() dumps the current profile information without clearing it.

```
long ProfilerDump( char* filename );
```

### Remarks

This can be useful for dumping intermediate results on a long task. If the specified file already exists, a new file is created with an incrementing number appended to the filename. This allows the dump to be called inside a loop with a constant filename.

A non-zero value from ProfilerDump() indicates that an error has occurred.

---

## ProfilerClear()

ProfilerClear() clears any profile information from the buffers.

```
void ProfilerClear( void );
```

### Remarks

ProfilerClear() retains the settings of collectionMethod and timeBase that were set by ProfilerInit(). It does not deallocate the buffers.



**Profiler**  
*Reference*

---

# Working with Hardware Tools

---

This chapter explains the CodeWarrior™ IDE hardware tools. Use these tools for board bring-up, test, and analysis.

**NOTE** Not all products support all the IDE features this chapter describes, such as the Flash programmer window, hardware diagnostic window, and logic analyzer. Some screen captures in this chapter were taken on a Windows PC; their actual appearance varies slightly on other host platforms.

This chapter consists of these sections:

- [Flash Programmer Window](#)
- [Hardware Diagnostics Window](#)
- [Trace Window](#)
- [Cache Window](#)
- [Profile Window](#)
- [Command Window](#)

## Flash Programmer Window

The **Flash Programmer** window lists global options for the flash programmer hardware tool. These preferences apply to every open project file.

[Figure 23.1](#) shows the Flash Programmer window. [Table 23.1](#) explains the items in the window.

To open the Flash Programmer window, select **Tools > Flash Programmer**.

The Flash Programmer window contains these panels:

- [Target Configuration](#)
- [Flash Configuration](#)
- [Program / Verify](#)
- [Erase / Blank Check](#)

## Working with Hardware Tools

### Flash Programmer Window

- [Checksum](#)

**Figure 23.1 Flash Programmer Window**

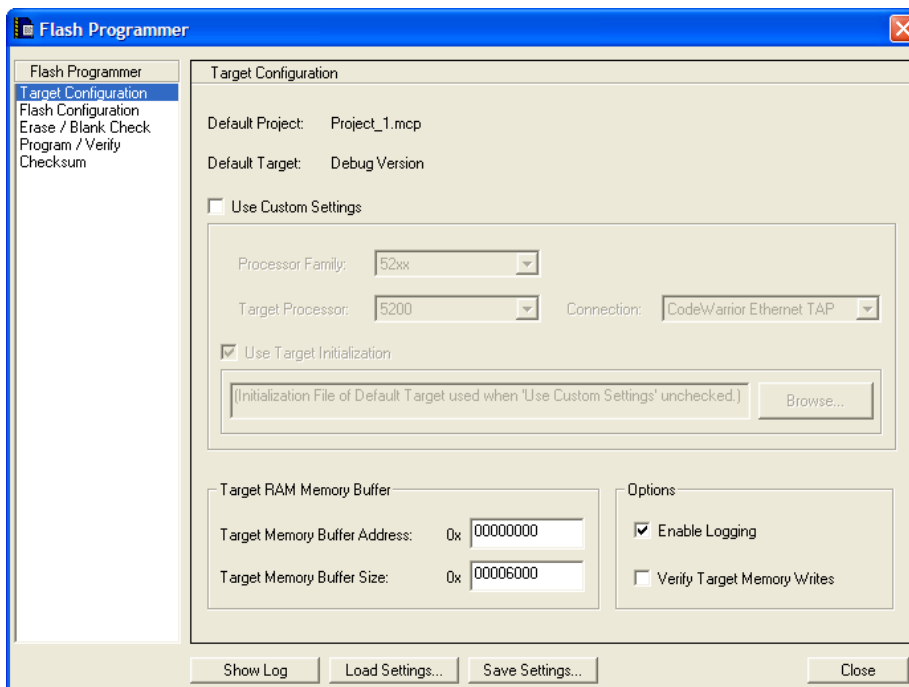

**Table 23.1 Flash Programmer Window Items**

Item	Explanation
Flash Programmer pane	Shows a list of panel names. Click a panel name to display that panel.
Show Log	Click to display a text file that logs flash programmer actions. Check the <b>Enable Logging</b> checkbox in the <b>Options</b> group to enable this button.
Load Settings	Click to restore previously saved settings for the current panel.

**Table 23.1 Flash Programmer Window Items (continued)**

Item	Explanation
Save Settings	Click to save settings for the current panel to a file.
Close	Click to close the window. You are prompted to save the settings if not saved already. Click Yes to save the settings.

## Target Configuration

The **Target Configuration** panel configures general flash programmer settings. [Figure 23.2](#) shows the Target Configuration panel. [Table 23.2](#) explains items in the panel.

**Figure 23.2 Target Configuration Panel**

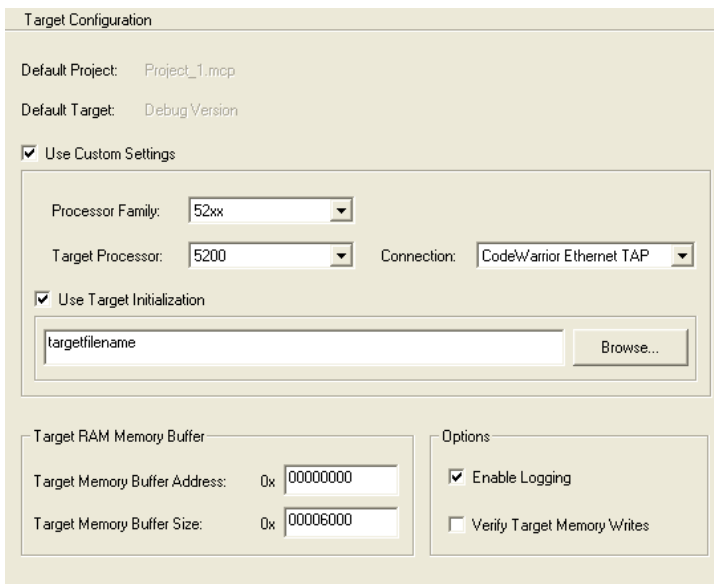

Target Configuration

Default Project: Project\_1.mcp  
Default Target: Debug Version

Use Custom Settings

Processor Family: 52xx  
Target Processor: 5200 Connection: CodeWarrior Ethernet TAP

Use Target Initialization

targetfilename

Target RAM Memory Buffer

Target Memory Buffer Address: 0x 00000000  
Target Memory Buffer Size: 0x 00006000

Options

Enable Logging  
 Verify Target Memory Writes

## Working with Hardware Tools

### Flash Programmer Window

**Table 23.2 Target Configuration Panel Items**

Item	Explanation
Default Project	Shows the current default project in the IDE.
Default Target	Shows the default build target. Clear the <b>Use Custom Settings</b> checkbox to have the IDE use connection settings from the build target for connecting to the hardware.
Use Custom Settings checkbox.	<p>Check to specify the connection information that you want to use for connecting to the hardware. In this case, the IDE can connect to the hardware without using settings from a project.</p> <p>Clear to use the connection information stored in the default project for connecting to the hardware. You cannot clear the checkbox if you do not have an active default project or default target.</p> <p>Connection information includes the information that you specify in the <b>Target Processor</b> list box, the <b>Connection</b> list box, and the <b>Use Target Initialization</b> text box.</p>
Processor Family list box	Select the processor family or architecture from which the target hardware is derived.
Target Processor text/list box	Use to specify the hardware processor.
Connection list box	Use to specify the method that the IDE uses to connect to the hardware.
Use Target Initialization checkbox and text box	<p>Check to specify an initialization file for the hardware connection. Enter the initialization file path in the text box, or click the <b>Browse</b> button to open a dialog box that you can use to specify the initialization file path.</p> <p>Clear if you do not want to use an initialization file for the hardware connection.</p>
Target Memory Buffer Address text box	<p>Specify the starting address of an area in RAM that the flash programmer can use as a scratch area. The flash programmer must be able to access this starting address through the remote connection (after the hardware initializes).</p> <p>The flash programmer should not modify any memory location other than the target memory buffer and flash memory.</p> <p>For example, the flash programmer uses the target memory buffer to download and execute the flash device driver.</p>



**Table 23.2 Target Configuration Panel Items (continued)**

Item	Explanation
Target Memory Buffer Size text box	<p>Specify the size of an area in RAM that the flash programmer can use as a scratch area, starting at the address you specify in the <b>Target Memory Buffer Address</b> text box.</p> <p>The flash programmer should not modify any memory location other than the target memory buffer and flash memory.</p>
Enable Logging checkbox	<p>Check to have the IDE generate detailed status information during flash operations. Checking this checkbox enables the <b>Show Log</b> button.</p> <p>Clear to disable logging of detailed status information during flash operations. Clearing this checkbox disables the <b>Show Log</b> button.</p> <p>Click the <b>Show Log</b> button to view the status information.</p>
Verify Target Memory Writes checkbox	<p>Check to have the IDE verify all write operations to the hardware RAM by reading the result of each write operation.</p> <p>Clear to have the IDE perform write operations without verifying them.</p>

## Flash Configuration

The **Flash Configuration** panel configures settings for the flash device on the hardware device. [Figure 23.3](#) shows the Flash Configuration panel. [Table 23.3](#) explains the items in the panel.

## Working with Hardware Tools

### Flash Programmer Window

**Figure 23.3 Flash Configuration Panel**

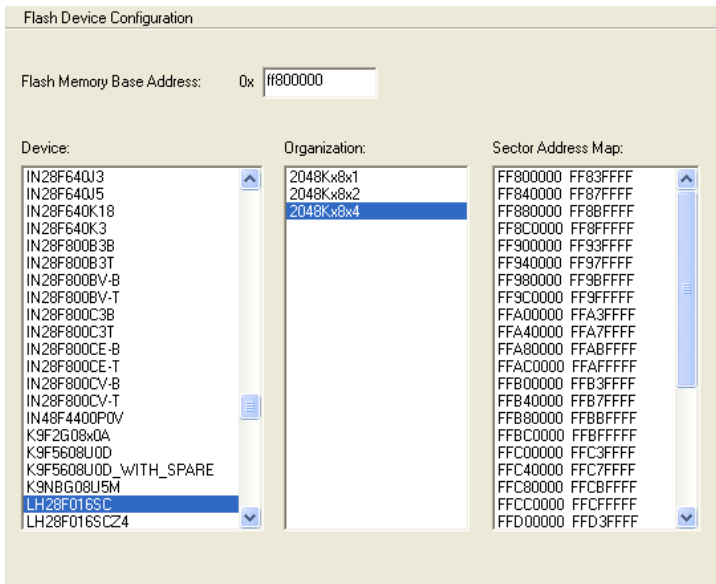

**Table 23.3 Flash Configuration Panel Items**

Item	Explanation
Flash Memory Base Address text box	Enter the base address of the beginning of flash memory on the hardware device. Enter the address based on the perspective of the hardware device.
Device pane	Shows an alphabetical list of supported flash device types. Select a device type from this pane. Your selection determines the contents of the <b>Organization</b> and <b>Sector Address Map</b> panes.

**Table 23.3 Flash Configuration Panel Items (continued)**

Item	Explanation
Organization pane	<p>Shows a list of supported layouts of flash memory in the hardware design, based on your selection in the <b>Device</b> pane. Each list item is of the form <i>ChipCapacityxDataBusWidthxNumberOfChipsInLayout</i>. Select an organization from this pane. Your selection determines the contents of the <b>Sector Address Map</b> pane.</p> <p>For example, 2048Kx8x2 indicates a chip capacity of 2048 kilobytes, a byte-wide interface to the data bus, and a 2-chip hardware layout.</p> <p>For hardware layouts of 2 or more chips, assume an interleaved organization. For example, for a 2048Kx16x2 organization, there are 2 chips on a 32-bit bus, and each chip provides 16 bits of data.</p>
Sector Address Map pane	<p>Shows a map of sector addresses that reflects your selections in the <b>Device</b> and <b>Organization</b> panes and your entry in the <b>Flash Memory Base Address</b> text box. This map is for informational purposes only.</p>

## Program / Verify

The **Program / Verify** panel lets you program an image into flash memory and verify the programming operation. [Figure 23.4](#) shows the Program / Verify panel. [Table 23.4](#) explains the items in the panel.

## Working with Hardware Tools

### Flash Programmer Window

**Figure 23.4 Program / Verify Panel**

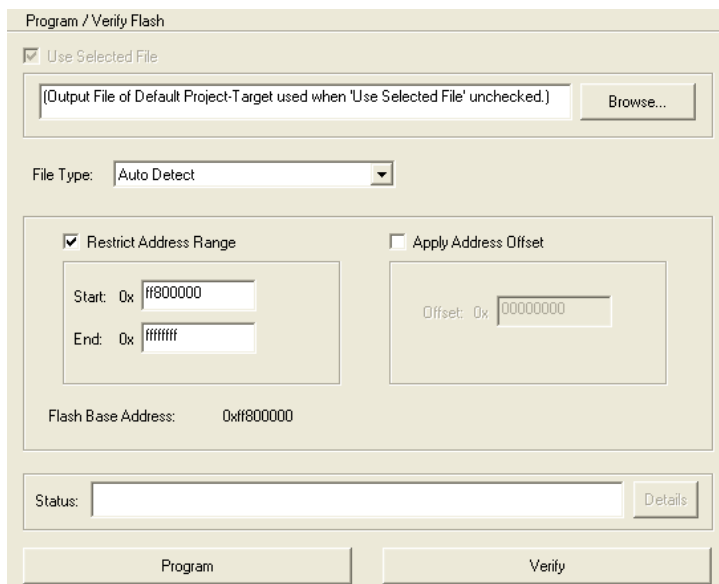

**Table 23.4 Program / Verify Panel Items**

Item	Explanation
Use Selected File	<p>Check to specify a file to program into flash memory. Enter the file path in the text box, or click the <b>Browse</b> button to locate the file path.</p> <p>Clear to have the IDE program flash memory with the file that the default build target determines.</p> <p>The file determines the address to which the IDE programs flash memory. If you specify a file that does not contain address information, such as a binary file, the IDE programs flash memory at address zero. Check the <b>Apply Address Offset</b> checkbox to specify an address offset from zero.</p>
File Type	Select the file type. Options are: Auto Detect, Binary/Raw Format, Elf Format, or Motorola S-Record Format.

**Table 23.4 Program / Verify Panel Items (continued)**

Item	Explanation
Restrict Address Range	<p>Check to use the <b>Start</b> and <b>End</b> text boxes to specify the address range in which you want the IDE to program flash data. If you use a binary file to program flash data, the flash programmer ignores data outside the address range that you specify.</p> <p>Clear to have the IDE determine the address range in which to program flash data.</p>
Start text box	<p>Enter the starting address of the range that you want the flash programmer to use for programming flash data.</p> <p>Check the <b>Restrict Address Range</b> checkbox to enable this text box.</p>
End text box	<p>Enter the ending address of the range that you want the flash programmer to use for programming flash data.</p> <p>Check the <b>Restrict Address Range</b> checkbox to enable this text box.</p>
Apply Address Offset checkbox	<p>Check to specify an offset at which to program flash data. The IDE adds this offset to the starting address that the file specifies. The flash programmer begins programming flash data at the starting address plus the offset.</p> <p>Clear to have the flash programmer begin programming flash data at the starting address that the file specifies. In this case, the IDE does not add an offset to the starting address.</p>
Offset text box	<p>Enter the offset to add to the starting address that the file specifies. The flash programmer begins programming flash data at the resulting address.</p> <p>Check the <b>Apply Address Offset</b> checkbox to enable this text box.</p>
Flash Base Address	<p>Shows the base address of the beginning of flash memory on the hardware device. This address is the same address that you specify in the <b>Flash Memory Base Address</b> text box of the <b>Flash Configuration</b> panel.</p>
Flash Base + Offset	<p>Shows the resulting address of adding the offset value that you specify in the <b>Offset</b> text box to the <b>Flash Base Address</b> value. The flash programmer begins programming flash data at this resulting address.</p>

## Working with Hardware Tools

### Flash Programmer Window

**Table 23.4 Program / Verify Panel Items (continued)**

Item	Explanation
Status	Shows flash programmer progress information. Click the <b>Details</b> button to show more thorough progress information. Click the <b>Program</b> or <b>Verify</b> button to enable the Details button.
Program button	Click to have the flash programmer program flash data into the hardware device. The <b>Status</b> reflects flash programmer progress.  The flash programmer does not check for blank flash memory before it begins programming the flash data.
Verify button	Click to have the IDE verify the data that the flash programmer programmed into the hardware device. The verify operation reads the flash data from the hardware device and compares that data against the image file on disk. The <b>Status</b> reflects flash programmer progress.

## Erase / Blank Check

The **Erase / Blank Check** panel lets you erase an image from flash memory and check for blank memory. [Figure 23.5](#) shows the Erase / Blank Check panel. [Table 23.5](#) explains items in the panel.

Figure 23.5 Erase / Blank Check Panel

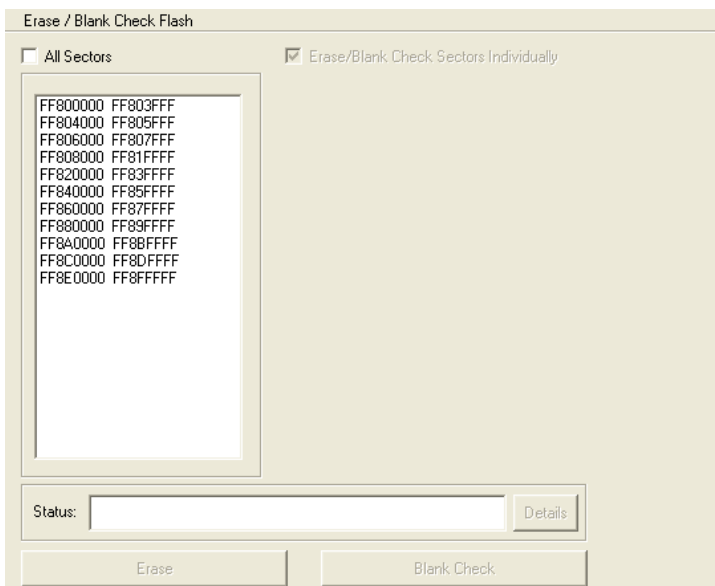

Table 23.5 Erase / Blank Check Panel Items

Item	Explanation
All Sectors checkbox and list	Check to apply the erase or blank check operation to the entire flash memory. Clear to specify sectors that you want to erase or check for blanks. Select sectors in the list below the checkbox.
Erase Sectors Individually checkbox	Check to have the flash programmer ignore chip erase commands and erase each individual sector instead. Clear to have the flash programmer obey chip erase commands and erase all sectors at once. Check the <b>All Sectors</b> checkbox to enable this checkbox.
Status	Shows flash programmer progress information. Click the <b>Details</b> button to show more thorough progress information. Click the <b>Erase</b> or <b>Blank Check</b> button to enable the Details button.

## Working with Hardware Tools

### Flash Programmer Window

**Table 23.5 Erase / Blank Check Panel Items (*continued*)**

Item	Explanation
Erase button	Click to have the flash programmer erase the sectors that you specified. The <b>Status</b> reflects flash programmer progress. Check the <b>All Sectors</b> checkbox to enable this button.
Blank Check button	Click to have the flash programmer perform these tasks: <ul style="list-style-type: none"> <li>• upload the sectors that you specified to the hardware device</li> <li>• compare the uploaded sectors against 0xff</li> <li>• report the values that do not match 0xff.</li> </ul> The <b>Status</b> reflects flash programmer progress. Check the <b>All Sectors</b> checkbox to enable this button.

## Checksum

The **Checksum** panel lets you calculate checksum values. [Figure 23.6](#) shows the Checksum panel. [Table 23.6](#) explains items in the panel.

**Figure 23.6 Checksum Panel**

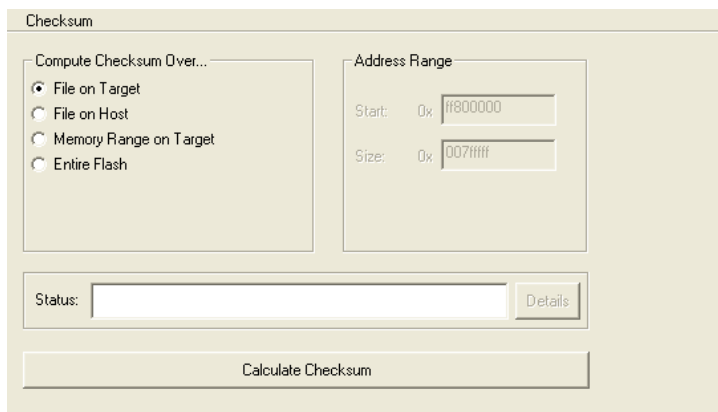



**Table 23.6 Checksum Panel Items**

Item	Explanation
File on Target	<p>Select to have the flash programmer read the file specified in the <b>Use Selected File</b> text box of the <b>Program / Verify</b> panel. The flash programmer reads this file to determine the required memory regions of the flash device for the checksum operation.</p> <p>The <b>Restrict Address Range</b> and <b>Apply Address Offset</b> information that you specify in the <b>Program / Verify</b> panel also apply to this option button.</p>
File on Host	<p>Select to have the flash programmer read the file on the host computer. The flash programmer reads this file to determine the required memory regions of the flash device for the checksum operation.</p> <p>The <b>Restrict Address Range</b> and <b>Apply Address Offset</b> information that you specify in the <b>Program / Verify</b> panel also apply to this option button.</p>
Memory Range on Target	<p>Select to have the flash programmer read the range that you specify in the <b>Start</b> and <b>Size</b> values in the <b>Address Range</b> group. The flash programmer uses this memory range for the checksum operation.</p>
Entire Flash	<p>Select to have the flash programmer read the entire contents of flash memory. The flash programmer uses this data for the checksum operation.</p>
Start text box	<p>Enter the starting address of the range that you want the flash programmer to use for the checksum operation.</p> <p>Select <b>Memory Range on Target</b> option to enable this text box.</p>
Size text box	<p>Enter the size of the address range that you want the flash programmer to use for the checksum operation. This size is relative to the starting address that you specify in the <b>Start</b> text box.</p> <p>Select <b>Memory Range on Target</b> option to enable this text box.</p>
Status	<p>Shows flash programmer progress information. Click the <b>Details</b> button to show more thorough progress information. Click the <b>Calculate Checksum</b> button to enable the Details button.</p>
Calculate Checksum	<p>Click to have the flash programmer calculate the checksum according to your specifications. At the end of the checksum operation, the <b>Status</b> shows the calculated checksum.</p>

## Hardware Diagnostics Window

The **Hardware Diagnostics** window lists global options for the hardware diagnostic tools. These preferences apply to every open project file.

[Figure 23.7](#) shows the Hardware Diagnostics window. [Table 23.7](#) explains items in the window.

To open the Hardware Diagnostics window, select **Tools > Hardware Diagnostics**.

The Hardware Diagnostics window has these panels:

- [Configuration](#)
- [Memory Read / Write](#)
- [Scope Loop](#)
- [Memory Tests](#)

**Figure 23.7** Hardware Diagnostics Window

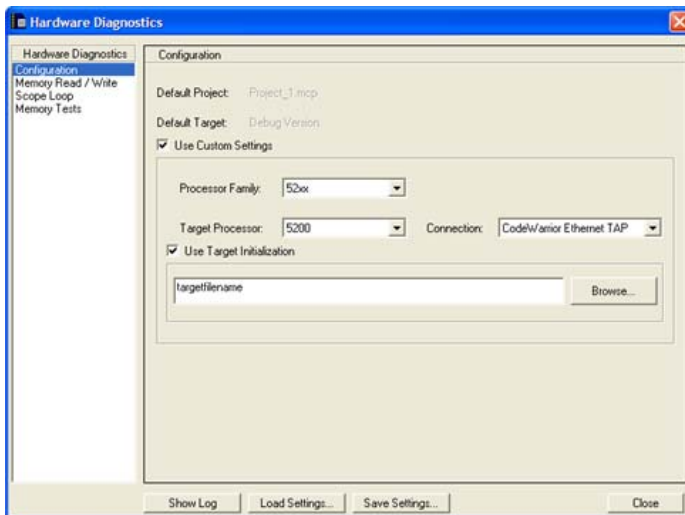

**Table 23.7** Hardware Diagnostics Window Items

Item	Explanation
Hardware Diagnostics pane	Shows a list of panel names. Click a panel name to display that panel in the <b>Hardware Diagnostics</b> window.
Show Log	Click to display a text file that logs hardware diagnostics actions.

**Table 23.7 Hardware Diagnostics Window Items (continued)**

Item	Explanation
Load Settings	Click to restore previously saved settings for the current panel.
Save Settings	Click to save settings for the current panel to a file.
Close button	Click to close the window. You are prompted to save the settings if not saved already. Click Yes to save the settings.

## Configuration

The **Configuration** panel configures general flash programmer settings. [Figure 23.8](#) shows the Configuration panel. [Table 23.8](#) explains items in the panel.

**Figure 23.8 Configuration Panel**

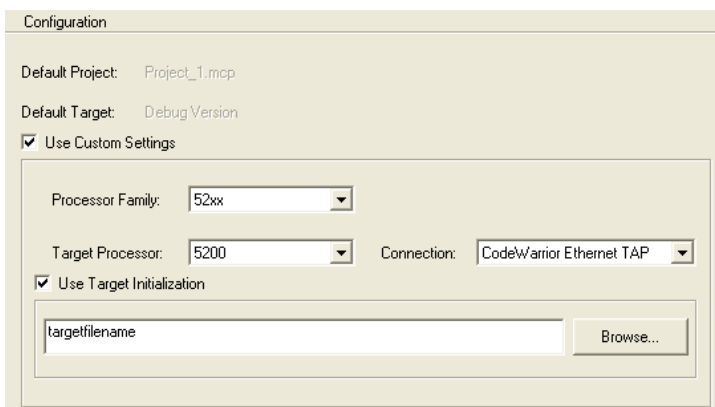

**Table 23.8 Configuration Panel Items**

Item	Explanation
Default Project	Shows the current default project in the IDE.
Default Target	Shows the default build target in the IDE. Clear the <b>Use Custom Settings</b> checkbox to have the IDE use the connection settings from the build target for diagnosing the hardware.

## Working with Hardware Tools

### Hardware Diagnostics Window

**Table 23.8 Configuration Panel Items (continued)**

Item	Explanation
Use Custom Settings checkbox.	<p>Check to specify the connection information that you want to use for diagnosing the hardware. In this case, the IDE can connect to the hardware without using settings from a project.</p> <p>Clear to use the connection information stored in the default project for connecting to the hardware. You cannot clear the checkbox if you do not have an active default project or default target.</p> <p>Connection information includes information that you specify in the <b>Target Processor</b> list box, the <b>Connection</b> list box, and the <b>Use Target Initialization</b> text box.</p>
Processor Family list box	Select the processor family or architecture from which the target hardware is derived.
Target Processor text/list box	Use to specify the hardware processor.
Connection list box	Use to specify the method that the IDE uses to connect to the hardware.
Use Target Initialization checkbox and text box	<p>Check to specify an initialization file for the hardware connection. Enter the initialization file path in the text box, or click the <b>Browse</b> button to locate the initialization file path.</p> <p>Clear if you do not want to use an initialization file for the hardware connection.</p>

## Memory Read / Write

The **Memory Read / Write** panel configures diagnostic tests for performing memory reads and writes over the remote connection interface. [Figure 23.9](#) shows the Memory Read / Write panel. [Table 23.9](#) explains items in the panel.

Figure 23.9 Memory Read / Write Panel

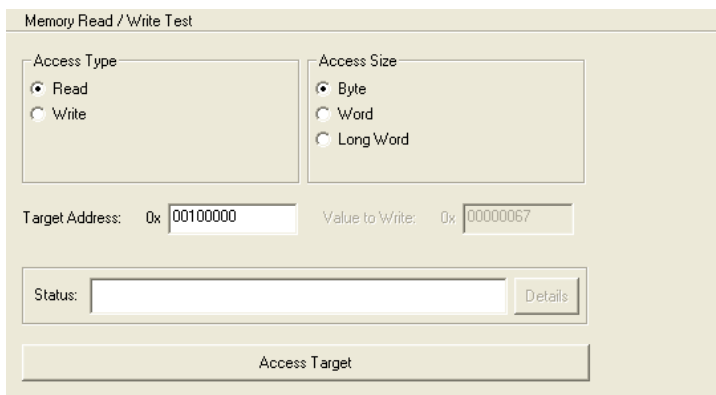

Table 23.9 Memory Read / Write Panel Items

Item	Explanation
Read	Select to have the hardware diagnostic tools perform read tests.
Write	Select to have the hardware diagnostic tools perform write tests.
Byte	Select to have the hardware diagnostic tools perform byte-size operations.
Word	Select to have the hardware diagnostic tools perform word-size operations.
Long Word	Select to have the hardware diagnostic tools perform long-word-size operations.
Target Address	Specify the address of an area in RAM that the hardware diagnostic tools should analyze. The tools must be able to access this starting address through the remote connection (after the hardware initializes).
Value to Write	Specify the value that the hardware diagnostic tools write during testing. Select the <b>Write</b> option to enable this text box.

## Working with Hardware Tools

### Hardware Diagnostics Window

**Table 23.9 Memory Read / Write Panel Items (continued)**

Item	Explanation
Status	Shows hardware diagnostic progress information. Click the <b>Details</b> button to show more progress information. Click the <b>Access Target</b> button to enable the Details button.
Access Target button	Click to have the hardware diagnostic tools perform specified tests. The <b>Status</b> shows test results.

## Scope Loop

The **Scope Loop** panel configures diagnostic tests for performing repeated memory reads and writes over the remote connection interface. The tests repeat until you stop them. By performing repeated read and write operations, you can use a scope analyzer or logic analyzer to debug the hardware device.

[Figure 23.10](#) shows the Scope Loop panel. [Table 23.10](#) explains items in the panel.

After the first 1000 operations, the **Status** shows the estimated time between operations.

---

**NOTE** For all values of **Speed**, the time between operations depends heavily on the processing speed of the host computer.

---

For **Read** operations, the Scope Loop test has an additional feature. During the first read operation, the hardware diagnostic tools store the value read from the hardware. For all successive read operations, the hardware diagnostic tools compare the read value to the stored value from the first read operation. If the Scope Loop test determines that the value read from the hardware is not stable, the diagnostic tools report the number of times that the read value differs from the first read value.

Figure 23.10 Scope Loop Panel

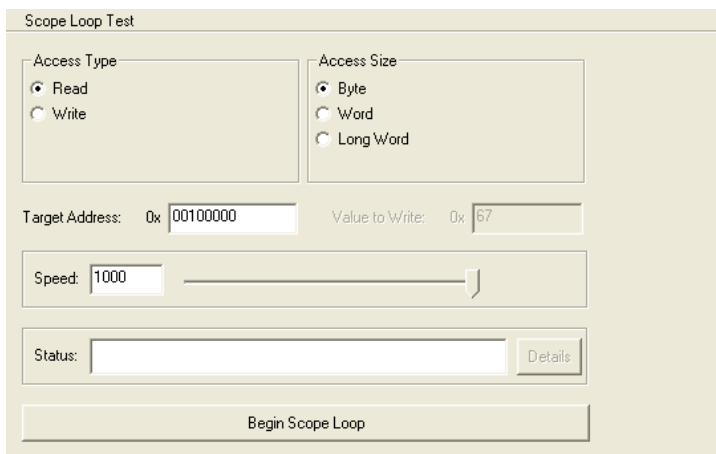

Table 23.10 Scope Loop Panel Items

Item	Explanation
Read	Select to have the hardware diagnostic tools perform read tests.
Write	Select to perform write tests.
Byte	Select to have the hardware diagnostic tools perform byte-size operations.
Word	Select to perform word-size operations.
Long Word	Select to perform long-word-size operations.
Target Address	Specify the address of an area in RAM that the hardware diagnostic tools should analyze. The tools must be able to access this starting address through the remote connection (after the hardware initializes).
Value to Write	Specify the value that the hardware diagnostic tools write during testing. Select the <b>Write</b> option to enable this text box.
Speed slider	Move to adjust the speed at which the hardware diagnostic tools repeat successive read and write operations. Lower speeds increase the delay between successive operations. Higher speeds decrease the delay between successive operations.

## Working with Hardware Tools

### Hardware Diagnostics Window

**Table 23.10 Scope Loop Panel Items (continued)**

Item	Explanation
Status	Shows hardware diagnostic progress information. Click the <b>Details</b> button to show more thorough progress information. Click the <b>Begin Scope Loop</b> button to enable the Details button.
Begin Scope Loop button	Click to have the hardware diagnostic tools perform your specified tests. The <b>Status</b> shows test results.

## Memory Tests

The **Memory Tests** panel lets you perform three different tests on the hardware:

- [Walking Ones](#)
- [Address](#)
- [Bus Noise](#)

[Figure 23.11](#) shows the Memory Tests panel. [Table 23.11](#) explains items in the panel.

You can specify any combination of tests and number of passes to perform. For each pass, the hardware diagnostic tools perform the tests in turn, until all passes are complete. The tools tally memory test failures and display them in a log window after all passes are complete. Errors resulting from memory test failures do not stop the testing process, however, fatal errors immediately stop the testing process.



Figure 23.11 Memory Tests Panel

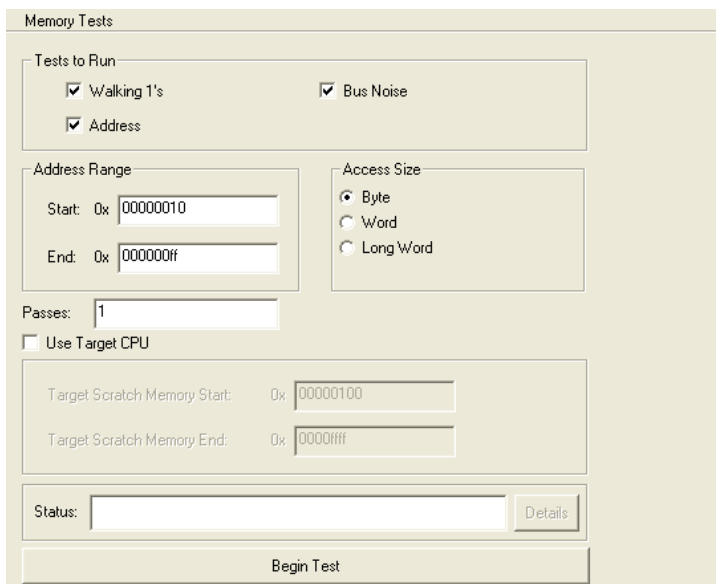

Table 23.11 Memory Tests Panel Items

Item	Explanation
Walking 1's	Check to have the hardware diagnostic tools perform the <a href="#">Walking Ones</a> test. Clear to have the diagnostic tools skip the <a href="#">Walking Ones</a> test.
Address	Check to have the hardware diagnostic tools perform the <a href="#">Address</a> test. Clear to have the diagnostic tools skip the <a href="#">Address</a> test.
Bus Noise	Check to have the hardware diagnostic tools perform the <a href="#">Bus Noise</a> test. Clear to have the diagnostic tools skip the <a href="#">Bus Noise</a> test.
Start:	Enter the starting address of the range that you want to test.
End:	Enter the ending address of the range that you want to test.
Byte	Select to have the hardware diagnostic tools perform byte-size operations.

## Working with Hardware Tools

### Hardware Diagnostics Window

**Table 23.11 Memory Tests Panel Items (continued)**

Item	Explanation
Word	Select to have the hardware diagnostic tools perform word-size operations.
Long Word	Select to have the hardware diagnostic tools perform long-word-size operations.
Passes	Enter the number of times that you want to repeat the specified tests.
Show Log	Click to display a text file that logs memory test actions.
Use Target CPU	<p>Check to have the hardware diagnostic tools download the test code to the hardware device. Enter in the <b>Target Scratch Memory Start</b> and <b>Target Scratch Memory End</b> text boxes the memory range that you want to use on the hardware device. The CPU on the hardware device executes the test code in this memory range.</p> <p>Clear to have the hardware diagnostic tools execute the test code through the remote connection interface.</p> <p>Execution performance improves greatly if you execute the test code on the hardware CPU, but requires that the hardware has enough stability and robustness to execute the test code.</p>
Target Scratch Memory Start	Specify the starting address of an area in RAM that the hardware diagnostic tools can use as a scratch area. The tools must be able to access this starting address through the remote connection (after the hardware initializes).
Target Scratch Memory End	Specify the ending address of an area in RAM that the hardware diagnostic tools can use as a scratch area. The tools must be able to access this address through the remote connection (after the hardware initializes).
Status	Shows memory test progress information. Click the <b>Details</b> button to show more thorough progress information. Click the <b>Begin Test</b> button to enable the Details button.
Begin Test	Click to have the hardware diagnostic tools perform the memory tests that you specified. The <b>Status</b> reflects memory test progress.

## Walking Ones

This test detects these memory faults:

- **Address Line**—The board or chip address lines are shorting or stuck at 0 or 1. Either condition could result in errors when the hardware reads and writes to the memory location. Because this error occurs on an address line, the data may end up in the wrong location on a write operation, or the hardware may access the wrong data on a read operation.
- **Data Line**—The board or chip data lines are shorting or stuck at 0 or 1. Either condition could result in corrupted values as the hardware transfers data to or from memory.
- **Retention**—The contents of a memory location change over time. The effect is that the memory fails to retain its contents over time.

The Walking Ones test includes four subtests:

- **Walking Ones**—This subtest first initializes memory to all zeros. Then the subtest writes, reads, and verifies bits, with each bit successively set from the least significant bit (LSB) to the most significant bit (MSB). The subtest configures bits such that by the time it sets the MSB, all bits set to a value of 1. This pattern repeats for each location within the memory range that you specify. For example, the values for a byte-based Walking Ones subtest occur in this order:

0x01, 0x03, 0x07, 0x0F, 0x1F, 0x3F, 0x7F, 0xFF

- **Ones Retention**—This subtest immediately follows the Walking Ones subtest. The Walking Ones subtest should leave each memory location with all bits set to 1. The Ones Retention subtest verifies that each location has all bits set to 1.
- **Walking Zeros**—This subtest first initializes memory to all ones. Then the subtest writes, reads, and verifies bits, with each bit successively set from the LSB to the MSB. The subtest configures bits such that by the time it sets the MSB, all bits are set to a value of 0. This pattern repeats for each location within the memory range that you specify. For example, the values for a byte-based Walking Zeros subtest occur in this order:

0xFE, 0xFC, 0xF8, 0xF0, 0xE0, 0xC0, 0x80, 0x00

- **Zeros Retention**—This subtest immediately follows the Walking Zeros subtest. The Walking Zeros subtest should leave each memory location with all bits set to 0. The Zeros Retention subtest verifies that each location has all bits set to 0.

## Address

This test detects memory aliasing. *Memory aliasing* exists when a physical memory block repeats one or more times in a logical memory space. Without knowing about this condition, you might conclude that there is much more physical memory than what actually exists.

The address test uses a simplistic technique to detect memory aliasing. The test writes sequentially increasing data values (starting at one and increasing by one) to each

## Working with Hardware Tools

### Hardware Diagnostics Window

---

successive memory location. The maximum data value is a prime number and its specific value depends on the addressing mode so as to not overflow the memory location.

The test uses a prime number of elements to avoid coinciding with binary math boundaries:

- For byte mode, the maximum prime number is  $2^8-5$  or 251.
- For word mode, the maximum prime number is  $2^{16}-15$  or 65521.
- For long word mode, the maximum prime number is  $2^{32}-5$  or 4294967291.

If the test reaches the maximum value, the value rolls over to 1 and starts incrementing again. This sequential pattern repeats throughout the memory under test. Then the test reads back the resulting memory and verifies it against the written patterns. Any deviation from the written order could indicate a memory aliasing condition.

## Bus Noise

This test stresses the memory system by causing many bits to flip from one memory access to the next (both addresses and data values). *Bus noise* occurs when many bits change consecutively from one memory access to another. This condition can occur on both address and data lines.

## Address lines

To force bit flips in address lines, the test uses three approaches:

- Sequential—This approach works sequentially through all of the memory under test, from lowest address to highest address. This sequential approach results in an average number of bit flips from one access to the next.
- Full Range Converging—This approach works from the fringes of the memory range toward the middle of the memory range. Memory access proceeds in this pattern, where *+ number* and *- number* refer to the next item location (the specific increment or decrement depends on byte, word, or long word address mode):
  - the lowest address
  - the highest address
  - (the lowest address) + 1
  - (the highest address) - 1
  - (the lowest address) + 2
  - (the highest address) - 2
- Maximum Invert Convergence—This approach uses calculated end point addresses to maximize the number of bits flipping from one access to the next. This approach involves identifying address end points such that the values have the maximum

---

inverted bits relative to one another. Specifically, the test identifies the lowest address with all 0x5 values in the least significant nibbles and the highest address with all 0xA values in the least significant nibbles. After the test identifies these end points, memory access alternates between low address and high address, working towards the center of the memory under test. Accessing memory in this manner, the test achieves the maximum number of bits flips from one access to the next.

## Data lines

To force bit flips in data lines, the test uses two sets of static data, a pseudo-random set and a fixed-pattern set. Each set contains 31 elements—a prime number. The test uses a prime number of elements to avoid coinciding with binary math boundaries. The sets are unique to each addressing mode so as to occupy the full range of bits.

- The test uses the pseudo-random data set to stress the data lines in a repeatable but pattern-less fashion.
- The test uses the fixed-pattern set to force significant numbers of data bits to flip from one access to the next.

The subtests execute similarly in that each subtest iterates through static data, writing values to memory. The test combines the three address line approaches with the two data sets to produce six unique subtests:

- Sequential with Random Data
- Sequential with Fixed Pattern Data
- Full Range Converging with Random Data
- Full Range Converging with Fixed Pattern Data
- Maximum Invert Convergence with Random Data
- Maximum Invert Convergence with Fixed Pattern Data

## Trace Window

After you configure your project to use a logic analyzer and collect trace data, you use the **Trace** window ([Figure 23.12](#)) to view the collected data. The trace window shows up to 100,000 states or trace frames, beginning with the most recent frame.

The IDE determines the column labels that appear in the Trace window at the time it connects to the logic analyzer. If you update these labels in the logic analyzer, your changes do not appear in the Trace window if you update data. In the IDE, you must disconnect from the logic analyzer and reconnect to it in order to update the column labels in the Trace window.

After you use a logic analyzer to collect trace data, open the Trace window by clicking **Data > View Trace**.

## Working with Hardware Tools

### Cache Window

Figure 23.12 Trace Window

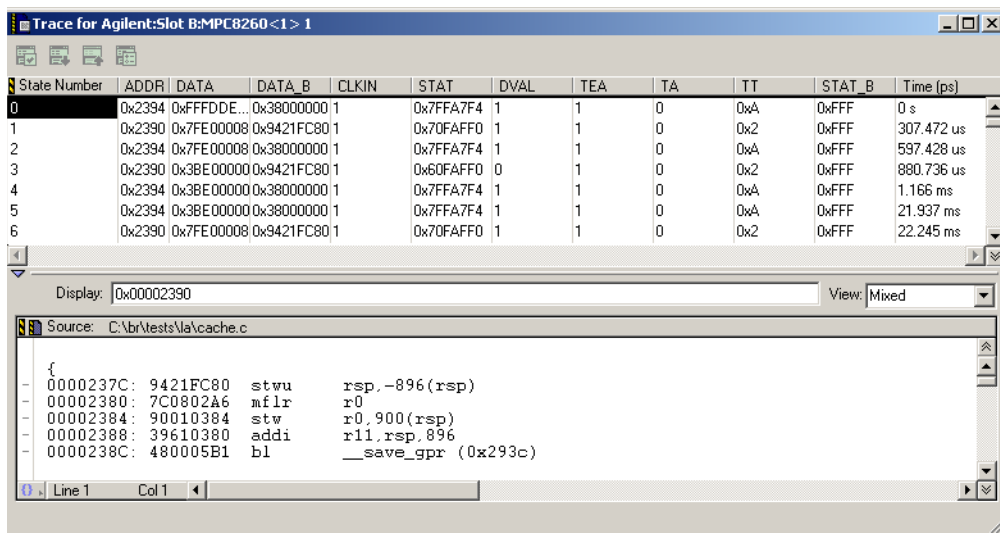

## Cache Window

Use the **Cache** window ([Figure 23.13](#)) to view cache information for the target processor. Click **Data > View Cache** to open the Cache window.

**NOTE** The **View Cache** menu might have additional supported commands, depending on the target processor. For example, you might be able to click **Data > View Cache > Instruction Cache** or **Data > View Cache > Data Cache** to view these two types of cache concurrently.

Figure 23.13 Cache Window

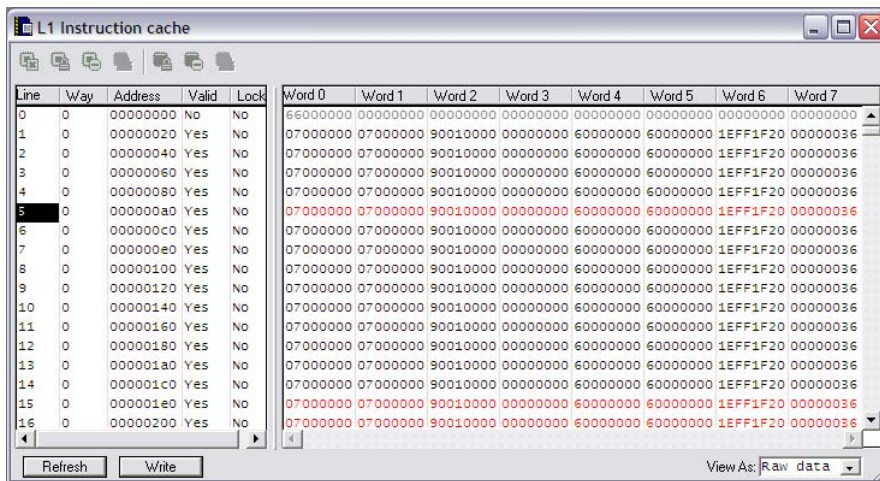

## Profile Window

Use the Profile window (Figure 23.14) to examine profile data that you collect from executing code. Examining this data helps you improve the performance of your project. You use profiler Application Programming Interface (API) calls or `#pragma` directives in your source code to turn on the profiler, collect profiling data, and turn off the profiler. For more information, refer to [Profiler](#).

**NOTE** The Profiler is only available if the target supports it. This feature is dependent upon support by the target-specific compiler and a profiling library.

To open the Profile window, add the appropriate API calls or `#pragma` directives to your source code, then debug your project. The Profile window opens automatically.

## Working with Hardware Tools

### Command Window

**Figure 23.14 Profile Window**

Function	Count	Time	%	+ Children	%	Average	Maximum	Minimum	Stack Space
arrays	1	5.4	38.4	5.4	38.4	5.4	5.4	5.4	0
bitfields	1	0.0	0.0	0.0	0.0	0.0	0.0	0.0	0
dbg_breakpoints	1	0.7	5.0	1.3	9.4	0.7	0.7	0.7	0
dbg_derived_types	1	3.8	27.2	10.5	74.4	3.8	3.8	3.8	0
dbg_expressions	1	0.0	0.0	0.0	0.0	0.0	0.0	0.0	0
dbg_simple_types	1	0.3	2.2	0.3	2.2	0.3	0.3	0.3	0
dbg_stack_crawl	1	0.7	4.7	2.0	14.0	0.7	0.7	0.7	0
enums	1	0.0	0.0	0.0	0.0	0.0	0.0	0.0	0
func1	1	0.6	4.4	0.6	4.4	0.6	0.6	0.6	0
func2	1	0.0	0.0	0.0	0.0	0.0	0.0	0.0	0
function1	1	0.7	5.2	1.3	9.3	0.7	0.7	0.7	0
function2	1	0.6	4.2	0.6	4.2	0.6	0.6	0.6	0
function3	1	0.0	0.0	0.0	0.0	0.0	0.0	0.0	0
structs	1	1.2	8.7	1.2	8.7	1.2	1.2	1.2	0
unions	1	0.0	0.0	0.0	0.0	0.0	0.0	0.0	0

## Command Window

The IDE supports a command-line interface to some of its features. You can use the command-line interface together with the TCL scripting engine. You can also issue a command line that saves a log file of command-line activity.

The **Command** window in the IDE shows the standard output and standard error streams of command-line activity. [Figure 23.15](#) shows the Command window.

**Figure 23.15 Command Window**

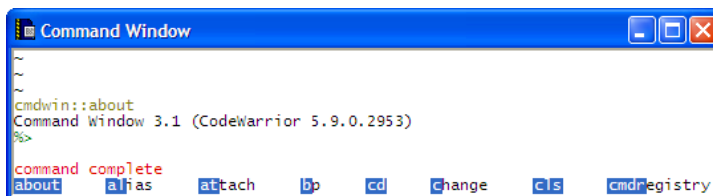

## Opening the Command Window

Use the **Command** window to view the standard output and standard error streams of command-line activity.

To open the Command window, select **View > Command Window**.



## Issuing Command Lines

Use the **Command** window to issue command lines to the IDE. For example, enter `debug` to start a debugging session.

To issue a command line, bring forward the Command window, type the command line, and press Enter or Return. The IDE executes the command line that you entered.

If you work with hardware as part of your project, you can use the Command window to issue command lines to the IDE while the hardware is running.

---

**NOTE** Enter `help` to see a list of available commands and a brief explanation of each command. Enter `help command` to see a detailed explanation of the `command`. Detailed information is provided in the IDE Automation Guide.

---



## **Working with Hardware Tools**

*Command Window*

---

# Compilers and Linkers

---

This section contains these chapters:

- [Compilers](#)
- [Linkers](#)



# Compilers

---

This chapter explains how to work with compilers in the CodeWarrior™ IDE. The IDE uses compilers to complete these tasks:

- Generate object code—the compiler translates source code into object code. Sample source code includes C++ files and Java files. Object code represents the same source instructions in a language that the computer directly understands.
- Flag syntax errors—the compiler highlights source code that generates syntax errors. Syntax errors result from failing to follow valid structure in a programming language. In C++, a common syntax error is forgetting to end a statement with a semicolon.

The following sections discuss the typical tasks for working with compilers:

- [Choosing a Compiler](#)
- [Compiling Projects](#)

## Choosing a Compiler

Choose a compiler to determine how the IDE interprets source code. The IDE uses a *plug-in* compiler architecture. This architecture provides these features:

- Modularity—the IDE associates a specific compiler plug-in with a particular programming language or environment. For example, a compiler plug-in exists for C++ source code, and another compiler plug-in exists for Java source code.
- Flexibility—as new programming languages develop, the IDE can use new compiler plug-ins.

The IDE associates common filename extensions with various plug-in compilers. For example, most Java files have the filename extension `.java`. The IDE associates these files with the Java compiler. The **File Mappings** panel provides control over such associations.

## Compiling Projects

Compile projects to process the source files that comprise a program and generate object code. The compiler flags syntax errors in the source files.

Use these tasks to compile projects:

## Compilers

### Compiling Projects

---

- Compile source files.
- Set the build order or link order.
- Update a project or its files.
- Create an executable file from a project.
- Run an application created from the project.
- Remove object code.

The following sections explain how to perform each task.

---

### Compiling Source Files

Use the **Compile** commands to compile source files into binary files. The IDE can compile a single file, multiple files, or all files in an open project.

1. Enable the Project window that contains the files to be compiled.
2. Select one or more files.
3. Choose **Project > Compile**.

The IDE compiles the selected files.

---

**NOTE** The **Project** menu contains most commands for compiling and linking projects. However, depending on the project type, some commands might be disabled or renamed.

---

---

### Setting the Build and Link Order of Files

Use the **Link Order** view in the Project window to specify the order in which the compiler and linker process files. Establishing the proper link order prevents link errors caused by file dependencies. The **Link Order** view is sometimes called the **Segments** view or **Overlays** view, depending on the target.

1. Click the **Link Order** tab in a Project window.
2. Click and drag files into the desired link order.

The IDE changes the link order. The build begins at the top of the link order, processes each file, and concludes at the bottom of the link order.

---

**NOTE** The IDE uses the new link order during subsequent **Update**, **Make**, **Run**, and **Debug** operations.

---

## Updating Projects

Use the **Bring Up To Date** command to compile, but not link, the newly added, modified, and touched files in a project. Unlike the **Make** and **Run** commands, the **Bring Up To Date** command does not produce a binary file.

1. Select the project to update.
2. Choose **Project > Bring Up To Date**.

The IDE compiles all uncompiled project files.

---

## Making Executable Files

Use the **Make** command to compile the newly-added, modified, and touched files in a project, then link them into a binary file. Unlike the **Run** command, the **Make** command does not execute the binary file. The **Make** command is useful for creating dynamic link libraries (DLLs), shared libraries, code resources, or tools.

1. Select the project to make.
2. Choose **Project > Make**.

The IDE processes the project and creates a binary file.

---

## Running Application Projects

Use the **Run** command to perform these tasks:

- Compile and link a project (if necessary).
- Create a standalone application.
- Change project settings (if required).
- Save the application.
- Run the application.

**NOTE** The **Run** command is not available if the project creates a non-executable file, such as a dynamic linked library (DLL), shared library, library, code resource, or tool.

---

1. Select the project to run.
  2. Choose **Project > Run**.
-

---

## Synchronizing File Modification Dates

Use the **Synchronize Modification Dates** command to update the modification dates of all files stored in a project. This command is useful for handling files from a third-party editor that does not share file-status information with the IDE.

1. Select the project window.
2. Choose **Project > Synchronize Modification Dates**.

The IDE checks the file-modification dates and marks modified files for re-compilation.

---

## Removing Object Code

Use the **Remove Object Code** command to remove binary object code stored in the project file and reduce project size.

1. Open the desired project.
2. Choose **Project > Remove Object Code...**
3. Set compaction options as desired.
  - Select **Recurse Subtargets and Subprojects** to remove object code from all subtargets and subprojects in the project file.
  - Select **Compact targets** to remove these items:
    - Target data files with the `.tdt` extension.
    - Browser data.
    - Dependency information.
    - Additional data cached by the IDE.
4. Select the method by which the IDE removes the object code.
  - Click **All Targets** to remove object code from all build targets.
  - Click **Current Target** to remove object code only from the active build target.

The IDE removes the specified object code from the project.



# Linkers

---

This chapter explains how to work with linkers in the CodeWarrior™ IDE. The IDE uses linkers to complete these tasks:

- Combine code—the linker combines source-file object code with object code from library files and other related files. The combined code represents a complete computer program.
- Create a binary file—the linker processes the complete program and generates a binary file. Sample binary files include applications and shared libraries.

The following sections discuss the typical tasks for working with linkers:

- [Choosing Linkers](#)
- [Linking Projects](#)

## Choosing Linkers

Choose a linker to determine the binary file type produced by the IDE. This list describes common binary files:

- Applications, or executable files, represent a wide body of computer programs. Common applications include word processors, web browsers, and multimedia players.
- Libraries contain code for use in developing new computer programs. Libraries simplify programming tasks and enhance re-usability.
- Specialized Files are designed for highly efficient operation in a specific context. Such files usually support a particular combination of hardware and software to perform tasks.

The IDE provides various linkers for software development. The **Target Settings** panel contains an option for selecting a linker. The IDE maps to each linker a group of recognized filename extensions. These mappings determine how the IDE interprets each file.

## Linking Projects

Link projects to process object code and generate a binary file. Refer to the CodeWarrior *Targeting* documentation for more information about linkers for specific computer systems. This section explains general-purpose linker tasks.

---

### Generating Project Link Maps

Use the **Generate Link Map** command to create a link-map file that contains function and cross-section information about the generated object code. The link map reveals the files, libraries, and functions ignored by the IDE while producing the binary output.

The IDE stores the link-map file in the project folder. The file uses the same name as the build target, with a `.MAP` or `.xMAP` extension.

1. Select the project window.
2. Choose **Edit > targetname Settings...**
3. Select the linker panel in the **Target Settings Panels** list.
4. Select the **Generate Link Map** option.
5. Click **OK**.
6. Choose **Project > Make**.

The IDE generates the link-map file.

# Preferences and Target Settings

---

This section contains these chapters:

- [Customizing the IDE](#)
- [Working with IDE Preferences](#)
- [Working with Target Settings](#)
- [Preference and Target Settings Options](#)
- [Register Details Window XML Specification](#)



# Customizing the IDE

---

The CodeWarrior™ IDE enables you to customize menus, toolbars, and key bindings to suit your programming preferences. Use the **Customize IDE Commands** window—which consists of the Commands and Toolbar Items tabs—to build customized menus, toolbars, and key bindings.

This chapter consists of these sections:

- [Customizing IDE Commands](#)
- [Customize Toolbars](#)
- [Customize Key Bindings](#)

## Customizing IDE Commands

You can customize the menu commands in the IDE's menu bar, as well as control the appearance of specific menu commands, create new command groups to distinguish menu commands, and associate a command line (Windows, Solaris, and Linux) with a new menu command. The customized menu commands you create have access to IDE information, such as the current editor selection, the frontmost window, and the current project and its output file.

Select **Edit > Commands & Key Bindings** to access the Customize IDE Commands window. [Figure 26.1](#) shows the Customize IDE Commands window. [Table 26.1](#) explains each button in the window. See the tasks in this chapter for more detailed information.

## Customizing the IDE

### Customizing IDE Commands

**Figure 26.1** Customize IDE Commands Window

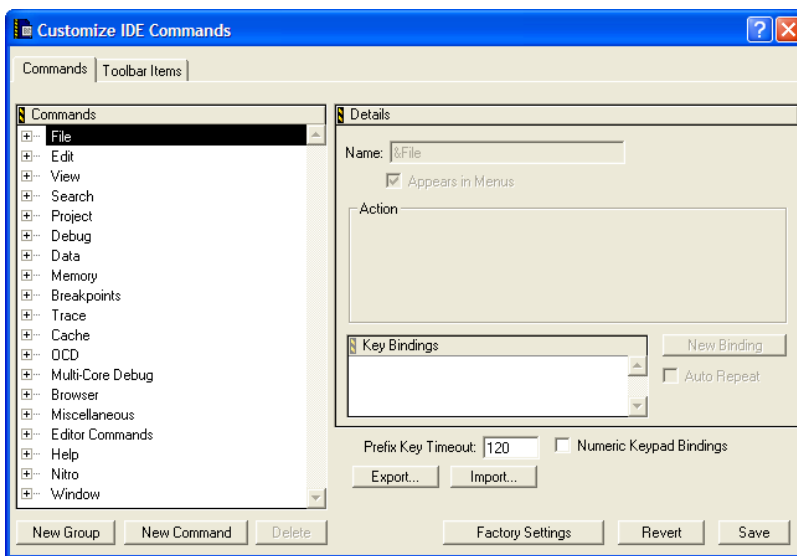

**Table 26.1** Customize IDE Commands Window Buttons

Button	Explanation
<b>New Group</b>	Click to add a new command group to the Commands list.
<b>New Command</b>	Click to add a new command setting within a group.
<b>Factory Settings</b>	Click to restore default options for the current Customize IDE Commands (Commands and Toolbar Items) lists.
<b>Revert</b>	Click to restore the most recently saved options for the current Customize IDE Commands (Commands and Toolbar Items) lists.
<b>Export</b>	Click to save a file that contains commands and key bindings to use later in the Customize IDE Commands lists.
<b>Import</b>	Click to open a file that contains commands and key bindings to use in the current Customize IDE Commands lists.
<b>Save</b>	Click to save customizations to the Customize IDE Commands list.

## Commands Tab

Click the **Commands** tab at the top of the Customize IDE Commands window to display the commands view. Use this view to modify existing menu commands, and to create and remove command groups and menu commands.

---

### Modifying Existing Commands

You can use the **Commands** tab of the Customize IDE Commands window to examine and modify existing command groups and menu commands. This view includes a Commands list. This hierarchical list organizes individual menu commands into command groups. Click the hierarchical control next to a command group to expand that group and view its contents.

To examine a particular item, select it in the Commands list. Information for the selected item appears on the right-hand side of the Customize IDE Commands window. This window provides this information for each selected item:

- **Name**—This field shows the name of the selected item. If the IDE does not permit you to change the name of the selected items, this field is grayed out.
- **Appears in Menus**—Enable this checkbox to display the selected item in the specified position in the CodeWarrior menu bar. For example, enabling this checkbox for a menu command allows that menu command to appear under the related command group in the menu bar. Disabling the checkbox prevents the menu command from appearing in the menu bar under the command group.
- **Action**—This section shows information about the action the selected item performs. For default menu commands, this section shows the command type, such as **Command** or **Hierarchical Menu**. For customized menu commands that you create, this section lets you specify a command line (Windows, Solaris, and Linux) that runs after you choose the customized menu command.
- **Key Bindings**—This area consists of the Key Bindings list, the **New Binding** button, and the **Auto Repeat** checkbox.

---

### Creating a New Command Group

To create a new command group for menu commands, follow these steps:

1. Click the **New Group** button.

The IDE creates a new command group called **New Group**, adds it to the Commands list, and displays its information in the Customize IDE Commands window.

2. Rename the new command group in the **Name** field.

## Customizing the IDE

### Customizing IDE Commands

---

3. Use the **Appears in Menu** checkbox to toggle the availability of the new command group in the IDE menu bar.

Select the **Appears in Menu** checkbox to display the new command group in the menu bar. Clear the checkbox if you do not want the command group to appear in the menu bar.

4. Click **Save**.

The IDE saves your new command group. If you selected the **Appears in Menu** checkbox, your new command group appears in the menu bar.

---

## Creating a New Menu Command

To create a new menu command, follow these steps:

1. Select the command group in which you want to create the new menu command.

You must select an existing command group in the Commands list.

2. Click the **New Command** button.

The IDE creates a new menu command named **New Command** and places it within the selected command group. The information for the new menu command appears in the Customize IDE Commands window.

3. Enter a name for the new menu command.

You can change the default name of **New Command**, as [Figure 26.2](#) shows. Enter a new name in the Name field of the Customize IDE Commands window.

4. Use the **Appears in Menu** checkbox to toggle the availability of the new command within its command group.

5. Define the desired Action for the new menu command.

6. Click **Save**.

The IDE saves your new menu command. If you check the **Appears in Menu** checkbox, the new menu command appears within the selected command group.

---

## Defining Command Actions (Windows)

[Figure 26.2](#) shows Command Action fields, which let you associate an action with the new menu command:



Figure 26.2 Command Action Fields

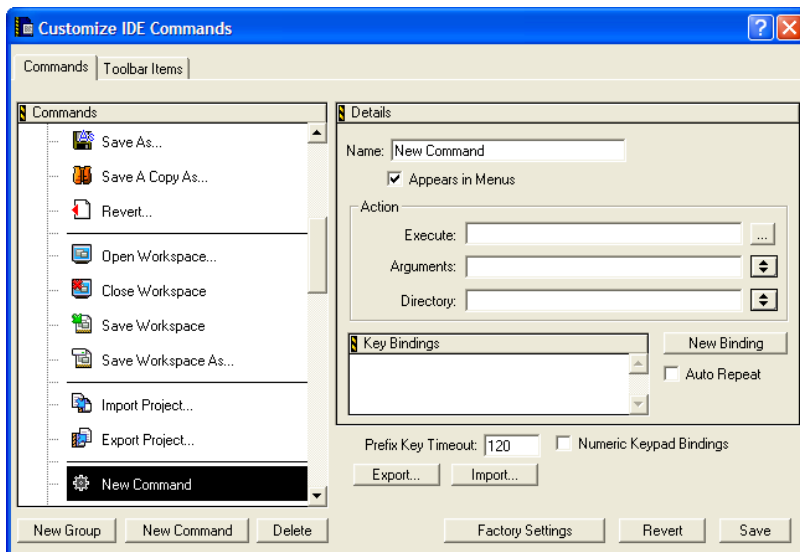

- **Execute**—Enter in this field a command to run an application. Alternatively, click the ellipsis button next to the field to select the application using a standard dialog box.
- **Arguments**—Enter the arguments that the IDE must pass to the application specified in the Execute field. Alternatively, select the desired arguments from the pop-up menu next to the field.
- **Directory**—Enter the working directory the IDE should use when it executes the application specified in the Execute field. Alternatively, select the desired directory from the pop-up menu next to the field.

## Pre-Defined Variables in Command Definitions

The IDE provides pre-defined variables for Windows, Solaris, and Linux to associate actions with commands. When you create a new command, you can use these pre-defined variables in command definitions to provide additional arguments that the IDE passes to the application (which is specified in the Execute field).

**NOTE** You can use variables that end with `Dir` as both argument and directory names.

## Customizing the IDE

### Customizing IDE Commands

[Figure 26.3](#) shows a list of pre-defined argument variables; [Figure 26.4](#) shows a list of pre-defined directory variables.

**Figure 26.3 Pre-Defined Argument Variables**

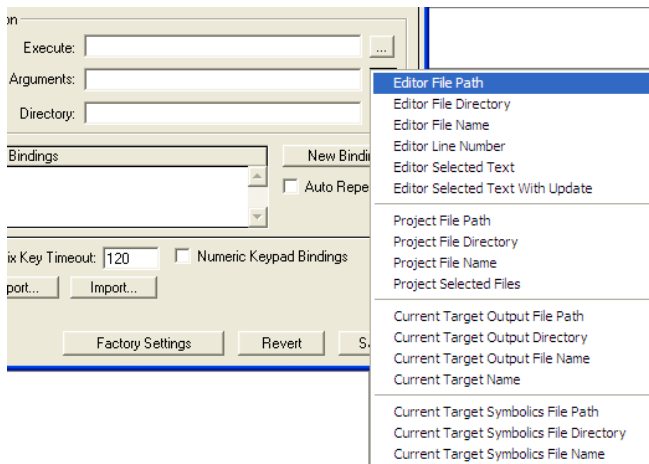

**Figure 26.4 Pre-Defined Directory Variables**

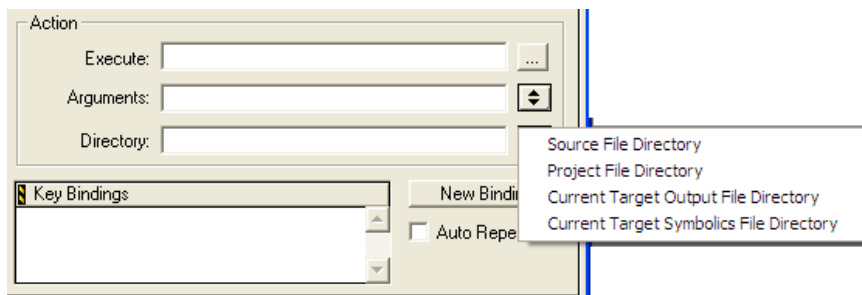

[Table 26.2](#) explains pre-defined variables for command-line arguments.

**Table 26.2 Pre-Defined Variables in Command Definitions**

Variable	Command-line output
%sourceFilePath	<b>sourceFilePath</b> is the frontmost editor window's full path.
%sourceFileDir	<b>sourceFileDir</b> is the frontmost editor window's directory.
%sourceFileName	<b>sourceFileName</b> is the frontmost editor window's filename.

**Table 26.2 Pre-Defined Variables in Command Definitions (*continued*)**

Variable	Command-line output
%sourceLineNumber	<b>sourceLineNumber</b> is the line number of the insertion point in the front window.
%sourceSelection	<b>sourceSelection</b> is the path to a temporary file containing the currently selected text.
%sourceSelUpdate	<b>sourceSelUpdate</b> is like <b>sourceSelection</b> , except the IDE waits for the command to finish and updates the selected text with the contents of the file.
%projectFilePath	<b>projectFilePath</b> is the full path of the front project window.
%projectFileDir	<b>projectFileDir</b> is the directory of the front project window.
%projectFileName	<b>projectFileName</b> is the filename of the front project window.
%projectSelectedFiles	<b>projectSelectedFiles</b> passes the selected filenames in the project window.
%targetFilePath	<b>targetFilePath</b> is the full path of the output file of the front project.
%targetFileDir	<b>targetFileDir</b> is the directory of the output file of the front project.
%targetFileName	<b>targetFileName</b> is the filename of the output file of the front project.
%currentTargetName	<b>currentTargetName</b> passes the name of the current target of the frontmost window.
%symFilePath	<b>symFilePath</b> is the full path to the symbolics file of the front project (can be the same as targetFile, such as CodeView).
%symFileDir	<b>symFileDir</b> is the full directory to the symbolics file of the front project (can be the same as targetFile, such as CodeView)
%symFileName	<b>symFileName</b> is the full filename to the symbolics file of the front project (can be the same as targetFile, such as CodeView)

## Using a Pre-defined Variable

To use a pre-defined variable, follow these steps:

## Customizing the IDE

### Customizing IDE Commands

---

1. Create a new menu command.

The IDE creates a new menu command named **New Command** and places it within your selected command group. The information for the new menu command appears in the Customize IDE Commands window.

2. Enter a name for the new menu command.
3. Use the **Appears in Menus** checkbox to toggle the availability of the new command within its command group.
4. Define the Action for the new menu command.
  - a. Enter in the **Execute** field a command line to run an application.
  - b. Next to the **Arguments** field, click on the arrow icon and select an argument listed in the pop-up menu.
  - c. Next to the **Directory** field, click on the arrow icon and select a directory listed in the pop-up menu.
5. Click **Save**.

The IDE saves your new menu command with the pre-defined variables. If you enabled the **Appears in Menus** checkbox, the new menu command appears within the selected command group.

---

## Deleting Command Groups and Menu Commands

You can delete the command groups and menu commands that you create for the IDE. Once removed, the command groups no longer appear in the IDE's menu bar, and the menu commands no longer activate their associated command lines (Windows).

---

**NOTE** If you need to temporarily remove your customized command groups and menu commands, consider exporting your settings. If you export your settings, you do not need to recreate them for using them in the future.

---

To delete a command group or menu command, follow these steps:

1. Select the command group or menu command you wish to delete.

If necessary, click the hierarchical control next to a group to expand and view its contents.
2. Click **Delete**.

After clicking the **Delete** button, the selected command group or menu command disappears from the Commands list.
3. Click **Save**.

Clicking the **Save** button confirms the deletion. The IDE removes deleted command groups from its menu bar. Deleted menu commands disappear from their respective command groups.

## Customize Toolbars

You can use the Toolbar Items page of the Customize IDE Commands window to put the commands you use often into your IDE toolbars. [Figure 26.5](#) shows this page.

The IDE toolbars contain a series of elements, each of which typically represents a menu command. After you click the element, the IDE executes the associated menu command. The toolbar can also contain elements that execute actions other than menu commands.

**Figure 26.5** Toolbar Items Page

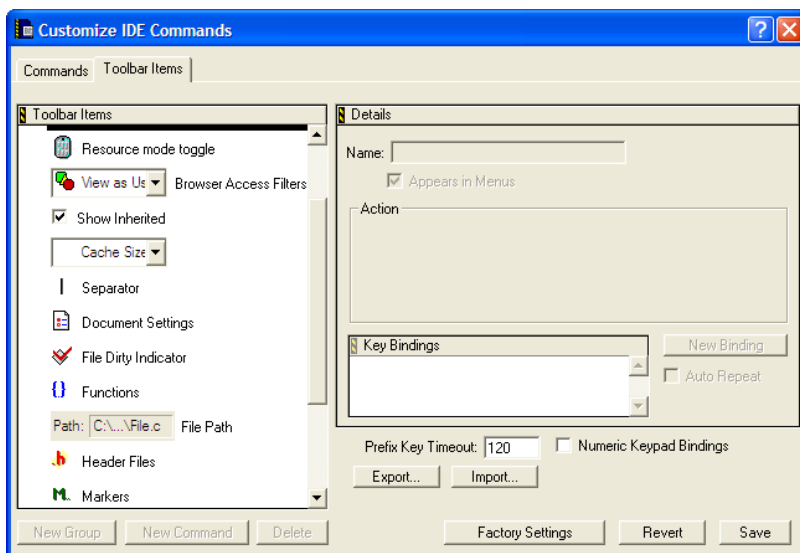

This section explains these topics:

- [Kinds of Toolbars](#)
- [Toolbar Elements](#)
- [Modify a Toolbar](#)

## Kinds of Toolbars

The CodeWarrior IDE uses two toolbar types:

## Customizing the IDE

### Customize Toolbars

- **Main toolbar (Windows OS)**—This toolbar ([Figure 26.6](#)), also known as the floating toolbar, is always available.
- **Window toolbars**—These toolbars appear in particular windows, such as the Project window toolbar ([Figure 26.7](#)) and the Browser window toolbar.

This distinction is important because you show, hide, clear, and reset the different toolbar types by using different sets of menu commands. These commands distinguish between the floating toolbar and the other window toolbars.

When you change one of these toolbar types, that change applies to every instance of that toolbar type you subsequently create. For example, if you modify the toolbar in an editor window, your changes appear in all editor windows opened thereafter.

**Figure 26.6 Main Toolbar (Windows OS)**

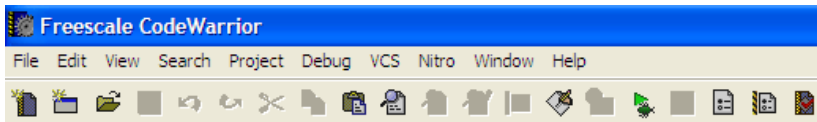

**Figure 26.7 Project Window Toolbar**



## Toolbar Elements

A toolbar can contain these elements:

- *Commands*—buttons that you click to execute IDE menu commands
- *Controls*—menus, such as Document Settings, Functions, Header Files, Markers, Version Control, and Current Target
- *Miscellaneous*—other elements, such as the File Dirty Indicator and File Path field

Click the **Toolbar Items** tab at the top of the Customize IDE Commands window to display the Toolbar view. Use this view to add new elements to a toolbar.

## Modify a Toolbar

You can modify a toolbar in these ways:

- Add a toolbar element
- Remove a toolbar element
- Clear all elements on a toolbar

- Reset a toolbar

In certain circumstances there are restrictions on which elements you can add or remove from a toolbar. For example, you cannot add a second instance of an element to the toolbar.

After you modify a toolbar, the changes apply to every instance of that toolbar. For example, if you customize the Project window toolbar, those changes will affect every Project window that you open, not just the toolbar in the active Project window. Your changes do not affect windows that are already open.

---

**TIP** To display a ToolTip that names a toolbar element, rest the cursor over the element.

---

---

## Adding a Toolbar Element

You add an element to a toolbar by dragging and dropping it from the Toolbar Items list onto a toolbar. This list is in the **Toolbar Items** view in the Customize IDE Commands window.

To add an element to a toolbar, follow these steps:

1. From the **Toolbar Items** list, select the icon next to the element that you want to add to a toolbar.

Make sure that the destination toolbar is visible.

2. Drag the element's icon from the Toolbar Items list to the destination toolbar.

On the Windows-hosted IDE, if the destination toolbar accepts the element, a framing bracket appears in the toolbar. This framing bracket shows you where the new element will appear after you release the cursor. If the destination toolbar does not accept the element, the framing bracket does not appear.

3. Release the element at the desired position.

After you release the element, the IDE inserts the element into the destination toolbar.

The toolbar might not accept an element for these reasons:

- The toolbar is full.
- The element already exists in the toolbar.
- The window does not support that element.
- The following elements can only be added to the editor window toolbar: Document Settings, Functions, Header Files, Markers, Version Control menus, File Dirty Indicator, and File Path field.

## Customizing the IDE

### Customize Toolbars

- The **Current Target** menu element can only be added to the Project window toolbar.

## Removing a Toolbar element

To remove an element from a toolbar, follow these steps:

1. Display a contextual menu for the button that you want to remove, as [Table 26.3](#) explains.

**Table 26.3** Displaying Contextual Menu for a Toolbar Button

On this host...	Do this...
Windows	Right-click the button.
Solaris	Control-click the button.
Linux	Ctrl-click the button.

2. Select the **Remove Toolbar Item** command from the contextual menu.

The IDE removes the button from the toolbar.

## Clearing All Buttons on Toolbars

You can clear all elements from a toolbar and build your own toolbar from scratch. [Table 26.4](#) explains how to clear the main (floating) toolbar and window toolbars.

**Table 26.4** Clearing Toolbars

On this host...	Do this to clear the main toolbar...	Do this to clear the window toolbar...
Windows	Select <b>View &gt; Toolbars &gt; Clear Main Toolbar</b> .	Select <b>View &gt; Toolbars &gt; Clear Window Toolbar</b> .
Solaris	Select <b>Window &gt; Toolbar &gt; Clear Floating Toolbar</b> .	Select <b>Window &gt; Toolbar &gt; Clear Window Toolbar</b> .
Linux	Select <b>Window &gt; Toolbar &gt; Clear Floating Toolbar</b> .	Select <b>Window &gt; Toolbar &gt; Clear Window Toolbar</b> .



## Reset Toolbars

Reset a toolbar to restore its default button set. [Table 26.5](#) explains how to reset the main (floating) toolbar and window toolbar by using menu commands.

**Table 26.5 Resetting a Toolbar by Using Menu Commands**

On this host...	Do this to reset the main toolbar...	Do this to reset the window toolbar...
Windows	Select <b>View &gt; Toolbars &gt; Reset Main Toolbar</b> .	Select <b>View &gt; Toolbars &gt; Reset Window Toolbar</b> .
Solaris	Select <b>Window &gt; Toolbar &gt; Reset Floating Toolbar</b> .	Select <b>Window &gt; Toolbar &gt; Reset Window Toolbar</b> .
Linux	Select <b>Window &gt; Toolbar &gt; Reset Floating Toolbar</b> .	Select <b>Window &gt; Toolbar &gt; Reset Window Toolbar</b> .

Alternatively, you can use a contextual menu to reset the main toolbar or a window toolbar. Once you reset the toolbar, the IDE restores the default toolbar button set. [Table 26.6](#) explains how to reset the main (floating) toolbar and window toolbar by using a contextual menu.

**Table 26.6 Resetting a Toolbar by Using a Contextual Menu**

On this host...	Do this to reset the main toolbar...	Do this to reset the window toolbar...
Windows	Right-click the toolbar and select <b>Reset Toolbar</b> .	Right-click the toolbar and select <b>Reset Toolbar</b> .
Solaris	Click and hold on the toolbar, then select <b>Reset Toolbar</b> .	Click and hold on the toolbar, then select <b>Reset Toolbar</b> .
Linux	Click and hold on the toolbar, then select <b>Reset Toolbar</b> .	Click and hold on the toolbar, then select <b>Reset Toolbar</b> .

## Customize Key Bindings

As [Figure 26.8](#) shows, you can customize the keyboard shortcuts, known as key bindings, for various commands in the CodeWarrior IDE. You can bind a set of keystrokes to

## Customizing the IDE

### Customize Key Bindings

virtually any command. To activate the command, type its associated key binding. Use the Customize IDE Commands window to change IDE key bindings.

You can also use the Customize IDE Commands window to look up default key bindings for specific commands, as well as change existing key bindings to better suit your needs.

Click the **Commands** tab at the top of the Customize IDE Commands window to display the Commands view. Use this view to configure key bindings for menu commands, editor actions, and other actions. You can also specify prefix keys.

This section has these topics:

- Modifying key bindings
- Adding key bindings
- Deleting key bindings
- Setting Auto Repeat for key bindings
- Exporting commands and key bindings
- Importing commands and key bindings
- Quote key prefix

**Figure 26.8 Customize IDE Commands—Key Bindings**

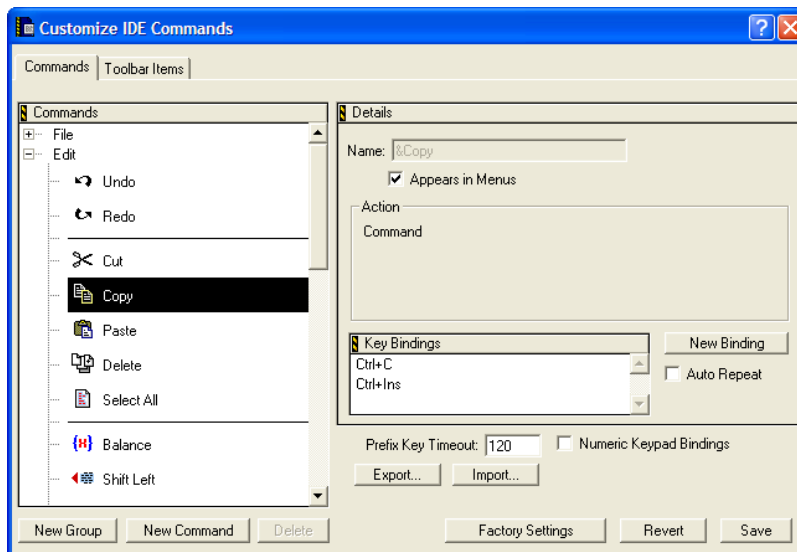

---

## Adding Key Bindings

Use the Customize IDE Commands window to specify additional key bindings for a particular command.

To add a key binding, follow these steps:

1. From the Commands list, select the command to which you want to add a new key binding.

Click the hierarchical controls next to the command categories to expand them as necessary so that you can see individual commands. Select the individual command you wish to modify.

---

**NOTE** If you want to use your keyboard's numeric keypad as part of the new key binding, check the **Numeric Keypad Bindings** checkbox in the Customize IDE **Commands** window.

---

2. Click **New Binding**. The **Edit Key Binding** dialog box ([Figure 26.9](#)) appears.

**Figure 26.9** Edit Key Binding Dialog Box

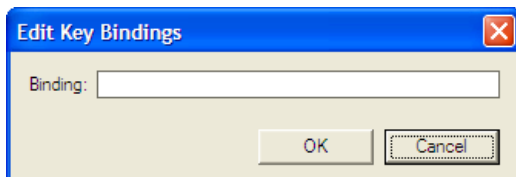

3. Create the key combination you would like to use for the selected command.  
For example, to add the key combination Ctrl-8, hold down the **Ctrl** key and press the **8** key, then release both keys at the same time.  
If you decide against the key combination that you just entered, or if you make a mistake, click **Cancel** in the **Edit Key Binding** dialog box. The IDE discards changes and returns you to the Customize IDE Commands window.
4. Click **OK** in the Edit Key Binding dialog box.  
The new key binding appears in the Key Bindings list in the Customize IDE Commands window.
5. Click **Save** in the Customize IDE Commands window to save your changes.  
The new key binding is now available for use in the IDE.

---

## Exporting Commands and Key Bindings

You can export to a file the custom commands and key bindings that you use with the IDE. You can then import the file into another IDE running on a different computer in order to transfer all of your custom commands and key bindings. This process simplifies your setup on the other computer because you do not have to recreate your custom commands and key bindings manually.

---

**NOTE** After you import your custom commands and key bindings into another computer, the IDE running on that computer first sets all its commands and key bindings to their default values, then imports your custom commands and key bindings.

---

To export your custom commands and key bindings, follow these steps:

1. Click **Export** in the Customize IDE Commands window.  
After you click this button, a standard **Save As** dialog box appears.
2. Select a location in which to save the `Commands&KeyBindings.mkb` file.  
This file contains information about your custom commands and key bindings.
3. Click **Save**.  
The IDE saves the `Commands&KeyBindings.mkb` file at the selected location.

---

**TIP** You can rename the `Commands&KeyBindings.mkb` file, but remember to preserve the `.mkb` extension. Furthermore, the Windows-hosted version of the CodeWarrior IDE uses this extension to properly recognize the commands and key bindings file.

---

---

## Importing Commands and Key Bindings

You can import custom commands and key bindings from a previously exported file. `Commands&KeyBindings.mkb` is the default name of an exported file for custom commands and key bindings.

---

**NOTE** After you import your custom commands and key bindings into another computer, the IDE running on that computer first sets all its commands and key bindings to their default values, then imports your custom commands and key bindings.

---

To import commands and key bindings, follow these steps:

1. Click **Import** in the Customize IDE Commands window.  
After you click this button, a standard **Open** dialog box appears.
2. Use the dialog box to find and open the `Commands&KeyBindings.mkb` file that you want to import.  
The IDE adds the custom commands and key bindings to the Customize IDE Commands window.

---

## Quote Key prefix

The Quote Key is a special prefix key that lets you use any character (such as a-z) as a command key without a modifier key, and still retain the ability to use that character normally, as in editor windows.

In typical use, a key equivalent involves two keys: a modifier key (such as the Ctrl key) combined with a printing key. However, the IDE does not require a modifier key.

For example, you can assign the **2** key (with no modifier) to a command. If you make this assignment, you can no longer type a 2 into your source code in the editor. This conflict occurs because the IDE now interprets the 2 as a command key instead of a printing key. The Quote Key prefix provides the solution to such conflicts.

You can configure the IDE to recognize any key as the Quote Key prefix. Despite its name, the Quote Key prefix does not have to be the key that creates the quote character (").

After typing an assigned Quote Key prefix, the IDE interprets the next keypress as a keystroke, not as a command.

Returning to the earlier example, assume that you assign the 2 key to a command and the tilde key (~) to be your Quote Key prefix. To execute the command, you would type the 2 key. To enter the character 2 into source code, you would type the tilde key first, then the 2 key. To enter the tilde character into source code, you would press the tilde key twice.

---

**WARNING!** The Quote Key only affects the next key or key combination that you type. You must use the Quote Key once for each bound key or key combination for which you want to type.

---

---

## Assigning the Quote Key prefix

To assign the Quote Key prefix:

## Customizing the IDE

### Customize Key Bindings

---

1. Click the expand control next to the Miscellaneous command group.  
Miscellaneous is part of the **Commands** list in the Customize IDE Commands window.
2. Select the **Quote Key** item.

---

**NOTE** If you want to use the numeric keypad as part of the new key binding, enable the **Numeric Keypad Bindings** checkbox in the Customize IDE Commands window.

---

3. Click **New Binding** to display the Edit Key Bindings dialog box.
4. Type the desired Quote Key prefix.  
The keys you type appear in the dialog box. If you make a mistake or decide against the keys you typed, click **Cancel** to return to the Customize IDE Commands window.
5. Click OK in the Edit Key Binding dialog box.  
The new Quote Key prefix appears in the Key Bindings list.

# Working with IDE Preferences

---

This chapter explains core CodeWarrior™ IDE preference panels and provides basic information on global- and project-level preference options. Consult the *Targeting* documentation for information on platform-specific preference panels.

This chapter consists of these sections:

- [IDE Preferences Window](#)
- [General Panels](#)
- [Editor Panels](#)
- [Debugger Panels](#)

## IDE Preferences Window

The **IDE Preferences** window ([Figure 27.1](#)) lists global IDE options. [Table 27.1](#) explains the items of this window. These preferences, unless superseded by a Target Settings option, apply to every open project file. Select **Edit > Preferences** to open the IDE Preferences window.

The IDE Preferences window lists preferences by group:

- **General**—configures overall IDE preferences, such as project builds, recent items, and third-party tools
- **Editor**—configures editor preferences, such as fonts, tabs, and syntax coloring
- **Debugger**—configures debugger preferences, such as window hiding during debugging sessions, low-level interactions, and variable highlighting

## Working with IDE Preferences

### IDE Preferences Window

Figure 27.1 IDE Preferences Window

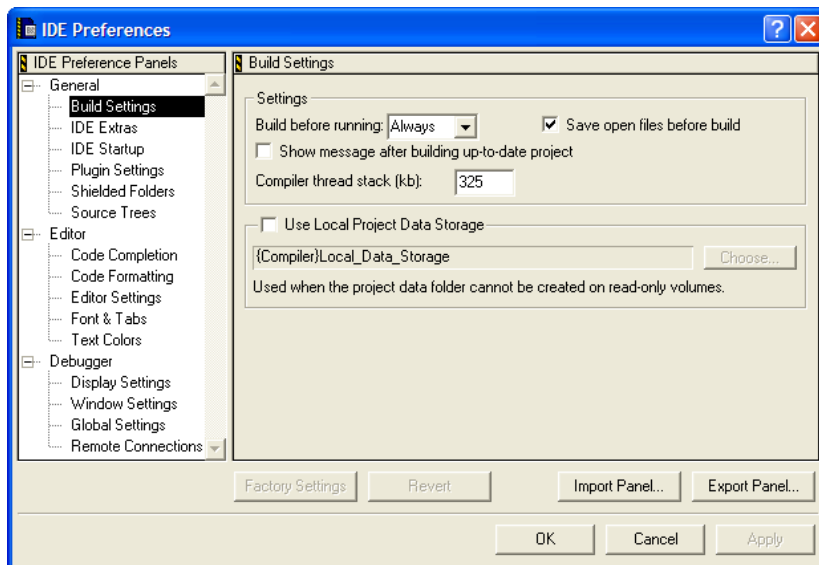

Table 27.1 IDE Preferences Window Items

Item	Explanation
IDE Preference Panels list	Lists preference panels, organized by group. Click the hierarchical control next to a group name to show or hide individual preference panels.
Preference panel	Shows options for the selected item in the <b>IDE Preference Panels</b> list.
<a href="#">Factory Settings</a>	Click to restore the default options for the current preference panel.
<a href="#">Revert Panel</a>	Click to restore the most recently saved options for the current preference panel.
<a href="#">Export Panel</a>	Click to save an XML file that contains options for the current preference panel.
<a href="#">Import Panel</a>	Click to open an XML file that contains options for the current preference panel.
OK (Windows)	Click to save modifications to all preference panels and close the window.



Table 27.1 IDE Preferences Window Items (*continued*)

Item	Explanation
Cancel (Windows)	Click to discard modifications to all preference panels and close the window.
Apply (Windows)	Click to confirm modifications to all preference panels.
Save (Solaris and Linux)	Click to save modifications to all preference panels.

## General Panels

The **General** section of the IDE Preference Panels defines basic options assigned to a new project.

The General preference panels available on most IDE hosts include:

- [Build Settings](#)
- [Concurrent Compiles](#)
- [IDE Extras](#)
- [IDE Startup](#)
- [Help Preferences \(Solaris and Linux\)](#)
- [Plugin Settings](#)
- [Shielded Folders](#)
- [Source Trees](#)

## Build Settings

The **Build Settings** preference panel ([Figure 27.2](#)) provides options for customizing various aspects of project builds, including:

- file actions during project builds
- memory usage to accelerate builds
- local data storage of projects stored on read-only volumes

[Table 27.2](#) explains the items of this panel.

## Working with IDE Preferences

### General Panels

**Figure 27.2 Build Settings Preference Panel**

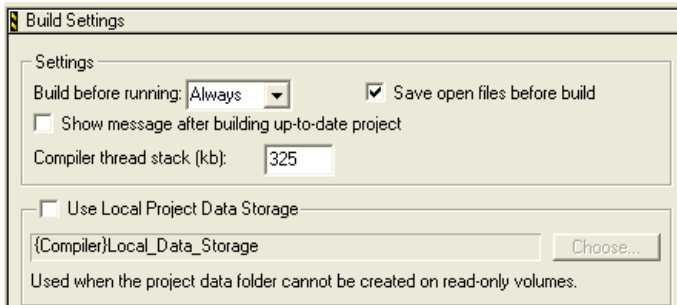

**Table 27.2 Build Settings Preference Panel Items**

Item	Explanation
<a href="#">Play sound after 'Bring Up To Date' &amp; 'Make'</a> (Solaris, and Linux)	Select to have the IDE play an alert sound after completing a <b>Bring Up To Date</b> or <b>Make</b> command.
<a href="#">Success</a> (Solaris and Linux)	Select the sound the IDE plays after successfully completing a <b>Bring Up To Date</b> or <b>Make</b> command.
<a href="#">Failure</a> (Solaris and Linux)	Select the sound the IDE plays after failing to complete a <b>Bring Up To Date</b> or <b>Make</b> command.
<a href="#">Build before running</a>	Select to always build the project before running it, never build the project before running it, or ask for the desired action prior to every build.
<a href="#">Save open files before build</a>	Check to automatically save the contents of all editor windows before starting a build.
<a href="#">Show message after building up-to-date project</a>	Check to have the IDE display a message after successfully building a project.
<a href="#">Compiler thread stack</a> (Windows)	Enter the kilobytes of memory to allocate to the stack for execution of the IDE compiler thread. Increase the size when compiling heavily optimized code.
<a href="#">Use Local Project Data Storage</a>	Check to specify a location to save project data if the project is on a read-only volume. Click <b>Choose</b> to select the location.

## Concurrent Compiles

The **Concurrent Compiles** preference panel ([Figure 27.3](#)) controls execution of simultaneous IDE compilation processes. The IDE lists this panel in the IDE Preference Panels list when the active compiler supports concurrency. [Table 27.3](#) explains the items of this panel.

The IDE uses concurrent compiles to compile code more efficiently. The IDE improves its use of available processor capacity by spawning multiple compile processes, which allow the operating system to perform these tasks as needed:

- optimize resource use
- use overlapped input/output

For those compilers that support concurrency, concurrent compiles improve compile time on both single- and multiple-processor systems.

**Figure 27.3 Concurrent Compiles Preference Panel**

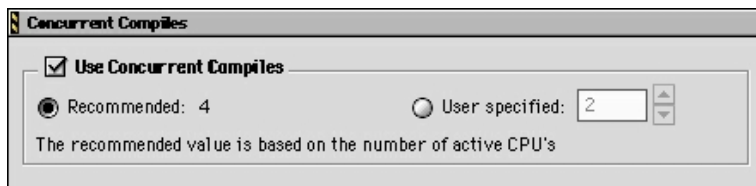

**Table 27.3 Concurrent Compiles Preference Panel Items**

Item	Explanation
<a href="#">Use Concurrent Compiles</a>	Check to have the IDE run multiple compilation processes simultaneously.
<a href="#">Recommended</a>	Select to allow the number of concurrent compiles suggested by the IDE.
<a href="#">User Specified</a>	Select to stipulate the number of concurrent compiles.

## IDE Extras

The **IDE Extras** preference panel ([Figure 27.4](#)) provides options for customizing various aspects of the IDE, including:

- menu-bar layout
- the number of recent projects, document files, and symbolics files to remember
- use of a third-party editor

## Working with IDE Preferences

### General Panels

[Table 27.4](#) explains the items of this panel.

**Figure 27.4 IDE Extras Preference Panel**

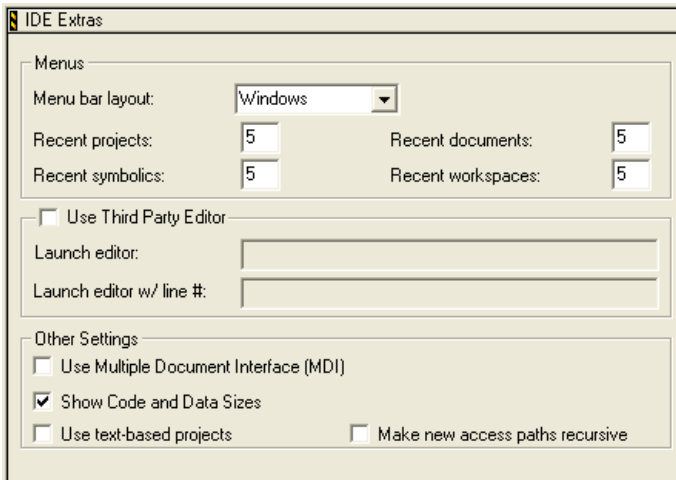

**Table 27.4 IDE Extras Preference Panel Items**

Item	Explanation
<a href="#">Menu bar layout</a>	Select a layout that organizes IDE menus into a typical host-platform menu bar. Restart the IDE in order for menu-bar layout changes to take effect.
<a href="#">Projects</a>	Enter the number of recently opened projects for the IDE to display in the <b>Open Recent</b> submenu. Enter zero to disable this feature.
<a href="#">Documents</a>	Enter the number of recently opened documents for the IDE to display in the <b>Open Recent</b> submenu. Enter zero to disable this feature.
<a href="#">Symbolics</a>	Enter the number of recently opened symbolics files for the IDE to display in the <b>Open Recent</b> submenu. Enter zero to disable this feature.
<a href="#">Workspaces</a>	Enter the number of recently opened workspaces for the IDE to display in the <b>Open Recent</b> submenu. Enter zero to disable this feature.

**Table 27.4 IDE Extras Preference Panel Items (continued)**

Item	Explanation
<a href="#">Context popup delay</a> (Solaris and Linux)	Enter the number of ticks to wait before displaying contextual menus. A tick is 1/60 of a second.
<a href="#">Use Third Party Editor</a> (Windows)	Check to use a third-party text editor to edit source files.
<a href="#">Launch Editor</a> (Windows)	Enter a command-line expression that runs the desired third-party text editor.
<a href="#">Launch Editor w/ Line #</a> (Windows)	Enter a command-line expression that runs the desired third-party text editor and passes to that editor an initial line of text to display.
<a href="#">Use Multiple Document Interface</a> (Windows)	Check to have the IDE use the Multiple Document Interface (MDI). Clear to have the IDE use the Floating Document Interface (FDI). Restart the IDE in order for interface changes to take effect.
<a href="#">Zoom windows to full screen</a> (Solaris and Linux)	Select to have zoomed windows fill the entire screen. Clear to have zoomed windows in a default size.
<a href="#">Use Script menu</a> (Solaris and Linux)	Select to display the Scripts menu in the menu bar. Clear to remove the Scripts menu from the menu bar.
<a href="#">Use External Editor</a> (Solaris and Linux)	Select to use a third-party text editor to edit text files in the current project. Clear to use the editor included with the IDE.
<a href="#">Show Code and Data Sizes</a> (Windows)	Displays or hides Code and Data columns in project manager.
<a href="#">Use Text-Based Projects</a>	Check to have the IDE use the text-based projects. With this option selected, IDE uses the XML-based files for a project instead of the binary mcp files.
<a href="#">Make new access paths recursive</a>	Selecting this option will create all new access paths as recursive. The default is off.

## IDE Startup

The **IDE Startup** preference panel ([Figure 27.5](#)) contains options that specify action to perform when IDE starts.

## Working with IDE Preferences

### General Panels

[Table 27.5](#) explains the items of this panel.

**Figure 27.5 IDE Startup Preference Panel**

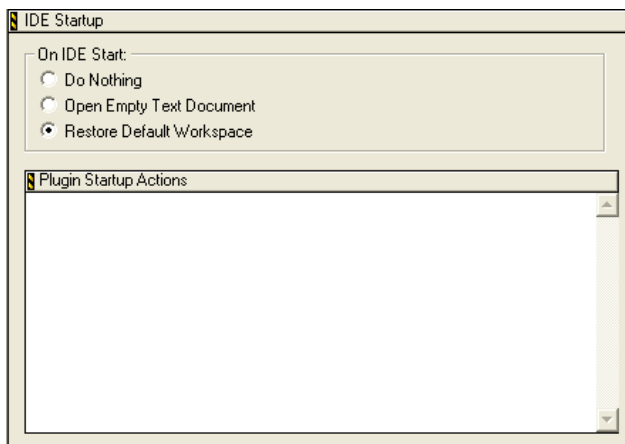

**Table 27.5 IDE Startup Preference Panel Items**

Item	Explanation
<a href="#">On IDE Start: Do Nothing</a>	Select to do nothing when IDE starts.
<a href="#">Open Empty Text Document</a>	Select to open an empty text document when IDE starts.
<a href="#">Restore Default Workspace</a>	Select this option to have the IDE save and restore state information for a workspace.
<a href="#">Plugin Startup Actions</a>	Use this field to configure plug-ins that perform startup actions.

## Help Preferences (Solaris and Linux)

The **Help Preferences** panel ([Figure 27.6](#)), available on the Solaris and Linux IDE hosts, specifies the browser used for viewing IDE online help. [Table 27.6](#) explains the items of this panel.

Figure 27.6 Help Preferences Panel (Solaris and Linux)



Table 27.6 Help Preferences Panel Items (Solaris and Linux)

Item	Explanation
<a href="#">Browser Path</a>	Enter a path to the browser that you want to use for viewing IDE online help. Alternatively, use the <b>Choose...</b> button.
Choose...	Click to select the path to the browser you want to use for viewing IDE online help.

## Plugin Settings

The **Plugin Settings** preference panel ([Figure 27.7](#)) contains options for troubleshooting third-party IDE plug-ins. [Table 27.7](#) explains the items of this panel.

Figure 27.7 Plugin Settings Preference Panel

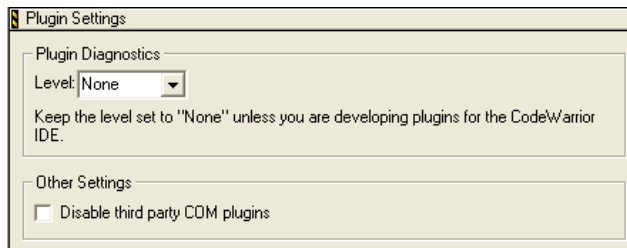

## Working with IDE Preferences

### General Panels

**Table 27.7 Plugin Settings Preference Panel Items**

Item	Explanation
<a href="#">Level</a>	Select the plug-in diagnostics level the IDE generates the next time it loads plug-ins. Restart the IDE in order for diagnostic-level changes to take effect. Options are None, Errors Only, and All Info.
<a href="#">Disable third party COM plug-ins</a>	Check to prevent the IDE from loading third-party Common Object Model (COM) plug-ins.

## Shielded Folders

The **Shielded Folders** preference panel ([Figure 27.8](#)) enables the IDE to ignore specified folders during project operations and find-and-compare operations. The IDE ignores folders based on matching names with regular expressions defined in the preference panel. [Table 27.8](#) explains the items of this panel; [Table 27.9](#) explains the default regular expressions in this panel.

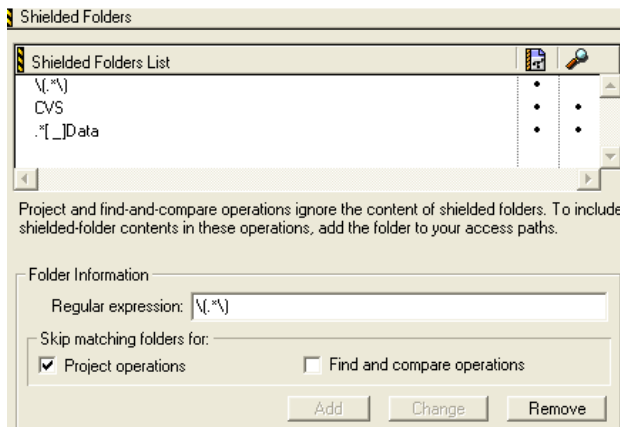

**NOTE** If the **Access Paths** settings panel in the Target Settings window contains a path to a shielded folder, the IDE overrides the shielding and includes the folder in project operations and find-and-compare operations.

**Figure 27.8 Shielded Folders Preference Panel**





**Table 27.8 Shielded Folders Preference Panel Items**

Item	Icon	Explanation
Shielded folder list		Lists folders that match the specified regular expression. The IDE skips these folders during project operations, find-and-compare operations, or both.
<a href="#">Regular Expression</a>		Enter the regular expression used to shield folders from selected operations.
<a href="#">Project operations</a>		Check to have the IDE skip folders during project operations. A bullet appears in the corresponding column of the shielded folder list.
<a href="#">Find and compare operations</a>		Check to have the IDE skip folders during find-and-compare operations. A bullet appears in the corresponding column of the shielded folder list.
Add		Click to add the current <b>Regular Expression</b> field entry to the shielded folder list.
Change		Click to replace the selected regular expression in the shielded folder list with the current <b>Regular Expression</b> field entry.
Remove		Click to delete the selected regular expression from the shielded folder list.

**Table 27.9 Default Regular Expressions in Shielded Folders Preference Panel**

Regular Expression	Explanation
<code>\ (. *\ )</code>	Matches folders with names that begin and end with parentheses, such as the (Project Stationery) folder.

## Working with IDE Preferences

### General Panels

**Table 27.9 Default Regular Expressions in Shielded Folders Preference Panel**

Regular Expression	Explanation
CVS	Matches folders named <code>CVS</code> . With this regular expression, the IDE skips Concurrent Versions System (CVS) data files.
<code>.*[_]Data</code>	Matches the names of folders generated by the IDE that store target data information, such as a folder named <code>MyProject_Data</code> .

## Source Trees

Use the **Source Trees** panel ([Figure 27.9](#)) to add, modify, and remove source trees (root paths) used in projects. Use source trees to define common access paths and build-target outputs to promote sharing of projects across different hosts. Source trees have these scopes:

- *Global source trees*, defined in the IDE Preferences window, apply to all projects.
- *Project source trees*, defined in the Target Settings window for a particular project, apply only to files in that project. Project source trees always take precedence over global source trees.

Except for the difference in scope, global and project source trees operate identically.

[Table 27.10](#) explains the items of this panel.

**Figure 27.9 Source Trees Panel**

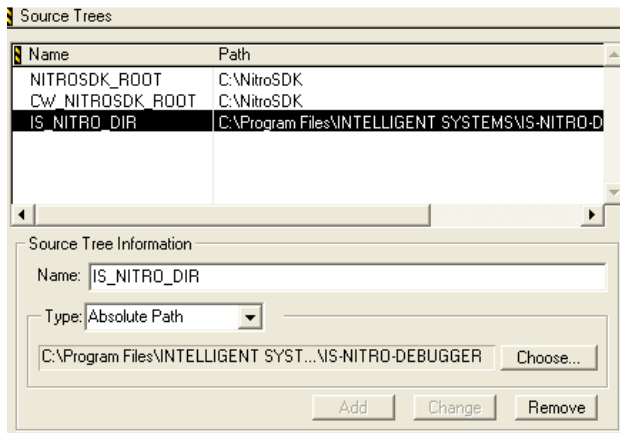

**Table 27.10 Source Trees Panel Items**

Item	Explanation
Source Tree list	Contains the <b>Name</b> and <b>Path</b> of currently defined source trees.
Name	Enter a name for a new source tree or modify the name of a selected source tree.
Type	Select the source-tree path type.
Choose	Click to select or modify a source-tree path.
Add	Click to add a new source-tree path to the Source Tree list.
Change	Click to modify the selected source-tree name or path.
Remove	Click to delete the selected source tree from the Source Tree list.

## Adding Source Trees

Add source trees that define root paths for access paths and build-target output.

1. Select **Edit > Preferences**.  
The IDE Preferences window appears.
2. Select the **Source Trees** panel from the **IDE Preference Panels** list.
3. Enter in the **Name** field a name for the new source tree.
4. Select the source tree **Type**:
  - **Absolute Path**—defines a path from the root level of the hard drive to a desired folder, including all intermediate folders
  - **Environment Variable**—defines an environment variable in the operating environment
  - **Registry Key**—(Windows) defines a key entry in the operating-environment registry
5. Enter the source-tree definition:
  - For **Absolute Path**—Click **Choose** to display a subordinate dialog box. Use the dialog box to select the desired folder. The absolute path to the selected folder appears in the **Source Trees** preference panel.
  - For **Environment Variable**—Enter the name of the desired environment variable.
  - For **Registry Key**—Enter the path to the desired key entry in the registry.

## Working with IDE Preferences

### General Panels

---

6. Click **Add**.

The IDE adds the new source tree to the **Source Trees** list.

7. Click **OK**, **Apply**, or **Save**.

The IDE saves the source-tree changes.

---

## Changing Source Trees

Change a source tree to update path information for a project. The IDE must be able to resolve source trees before building the project.

1. Select **Edit > Preferences**.
2. Select the **Source Trees** panel from the **IDE Preference Panels** list.
3. Select the desired source tree in the **Source Trees** list.
4. If needed, enter a new name for the selected source tree.
5. If needed, choose a new path type for the selected source tree.
6. Click **Change**.

The IDE updates the source tree and displays changes in the **Source Trees** list. A reminder message to update source-tree references in the project appears.

7. Click **OK**, **Apply**, or **Save**.

The IDE saves the source-tree changes.

---

## Removing Source Trees

Remove source trees that the project no longer uses. The IDE must be able to find the remaining source trees before building the project.

1. Select **Edit > Preferences**.
2. Select the **Source Trees** panel from the **IDE Preference Panels** list.
3. Select the source tree from the **Source Trees** list.
4. Click **Remove**.

The IDE updates the **Source Trees** list. A reminder message to update source-tree references in the project appears.

5. Click **OK**, **Apply**, or **Save**.

The IDE saves the source-tree changes.

---

## Editor Panels

The **Editor** section of the IDE Preference Panels list defines the editor settings assigned to a new project.

The Editor preference panels available on most IDE hosts include:

- [Code Completion](#)
- [Code Formatting](#)
- [Editor Settings](#)
- [Font & Tabs](#)
- [Text Colors](#)

## Code Completion

The **Code Completion** preference panel ([Figure 27.10](#)) provides options for customizing the IDE code-completion behavior, including:

- automatic invocation and indexing
- window positioning and appearance delay
- case sensitivity

[Table 27.11](#) explains the items of this panel.

**Figure 27.10 Code Completion Preference Panel**

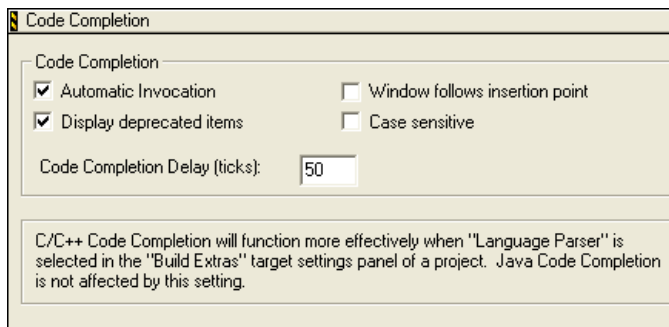

**Table 27.11 Code Completion Preference Panel Items**

Item	Explanation
<a href="#">Automatic Invocation</a>	Check to automatically open the Code Completion window to complete programming-language symbols. Clear to manually open the window.
<a href="#">Window follows insertion point</a>	Check to have the Code Completion window follow the insertion point as you edit text. Clear to leave the window in place.
<a href="#">Display deprecated items</a>	Check to have the Code Completion window display obsolete items in gray text. Clear to have the window hide obsolete items.
<a href="#">Case sensitive</a>	Check to have the IDE consider case when completing code. Clear to have the IDE ignore case.
<a href="#">Code Completion Delay</a> (ticks)	Enter the number of ticks to wait before opening the Code Completion window. A tick is 1/60 of a second.

## Code Formatting

The **Code Formatting** preference panel ([Figure 27.11](#)) provides options for customizing editor code-formatting behavior, including:

- indenting
- syntax placement
- brace handling

[Table 27.12](#) explains the items of this panel.

Figure 27.11 Code Formatting Preference Panel

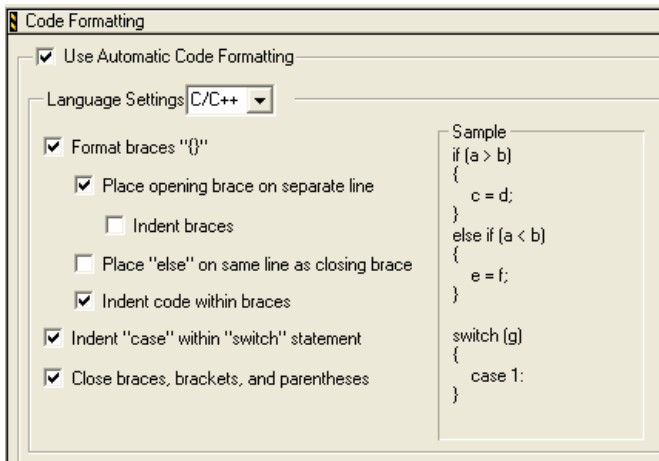

Table 27.12 Code Formatting Preference Panel Items

Item	Explanation
Use Automatic Code Formatting	Check to have the editor automatically format your source code according to settings in this panel.  Clear to prevent the editor from automatically formatting your code.
Language Settings	Use to specify the language type that you want to format. Your selection changes the other options in this panel to their default states for the selected language.
Format braces	Check to have the editor automatically insert a closing brace when you type an opening brace. The editor places the cursor between the opening brace that you typed and the closing brace that it inserts.  Clear to prevent the editor from automatically inserting a closing brace when you type an opening brace.
Place opening brace on separate line	Check to have the editor place on the next line an opening brace that you type.  Clear to prevent the editor from placing on the next line an opening brace that you type.

## Working with IDE Preferences

### Editor Panels

**Table 27.12 Code Formatting Preference Panel Items (continued)**

Item	Explanation
Indent braces	<p>Check to have the editor indent braces by one tab stop from the previous line.</p> <p>Clear to prevent the editor from indenting braces by one tab stop from the previous line.</p>
Place “else” on same line as closing brace	<p>Check to have the editor place <code>else</code> and <code>else if</code> text on the same line as the closing brace of the <code>if</code> or <code>else if</code> statement.</p> <p>Clear to prevent the editor from placing <code>else</code> and <code>else if</code> text on the same line as the closing brace of the <code>if</code> or <code>else if</code> statement.</p>
Indent code within braces	<p>Check to have the editor indent code by one tab stop from the braces.</p> <p>Clear to prevent the editor from indenting code by one tab stop from the braces.</p>
Indent “case” within “switch” statement	<p>Check to have the editor indent <code>case</code> statements by one tab stop inside a <code>switch</code> statement.</p> <p>Clear to prevent the editor from indenting <code>case</code> statements by one tab stop inside a <code>switch</code> statement.</p>
Close braces, brackets, and parentheses	<p>Check to have the editor automatically insert the corresponding closing character when you type an opening brace, bracket, or parenthesis. The editor places the cursor between the opening character and the closing character.</p> <p>Clear to prevent the editor from automatically inserting the corresponding closing character when you type an opening brace, bracket, or parenthesis.</p>

## Editor Settings

The **Editor Settings** preference panel ([Figure 27.12](#)) provides options for customizing the editor, including:

- fonts, window locations, and insertion-point positions
- contextual menus
- additional editor-window features



[Table 27.13](#) explains the items of this panel.

**Figure 27.12 Editor Settings Preference Panel**

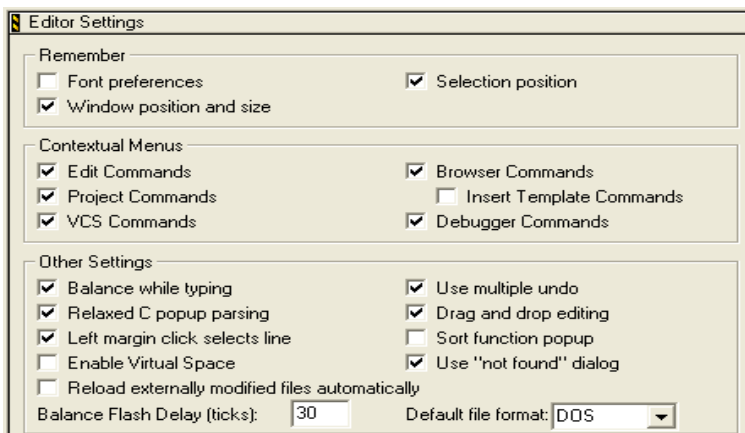

**Table 27.13 Editor Settings Preference Panel Items**

Item	Explanation
<a href="#">Font preferences</a>	Check to retain font settings for each source file. Clear to apply default font settings each time the IDE displays the source file.
<a href="#">Selection Position</a>	Check to retain the text-insertion position in each source file.
<a href="#">Window position and size</a>	Check to retain the location and dimensions of each editor window.
<a href="#">Edit Commands</a>	Check to add <b>Edit</b> menu commands to contextual menus.
<a href="#">Browser Commands</a>	Check to add <b>Browser</b> menu commands to contextual menus. Also select in order to use the <b>Insert Template Commands</b> option.
<a href="#">Project Commands</a>	Check to add <b>Project</b> menu commands to contextual menus.
<a href="#">VCS Commands</a>	Check to add <b>VCS</b> (Version Control System) menu commands to contextual menus.

## Working with IDE Preferences

### Editor Panels

**Table 27.13 Editor Settings Preference Panel Items (continued)**

Item	Explanation
<a href="#">Debugger Commands</a>	Check to add <b>Debug</b> menu commands to contextual menus.
<a href="#">Balance while typing</a>	Check to flash the matching (, [, or { after typing ), ], or } in an editor window.
<a href="#">Use multiple undo</a>	Check to allow multiple undo and redo operations while editing text.
<a href="#">Relaxed C popup parsing</a>	Check to allow the C parser to recognize some non-standard function formats and avoid skipping or misinterpreting some definition styles.
<a href="#">Drag and drop editing</a>	Check to allow drag-and-drop text editing.
<a href="#">Left margin click selects line</a>	Check to allow selection of an entire line of text by clicking in the left margin of the editor window.
<a href="#">Sort function popup</a>	Check to sort function names by alphabetical order in menus. Clear to sort function names by order of appearance in the source file.
<a href="#">Enable Virtual Space (Windows)</a>	Check to allow moving the text-insertion point beyond the end of a source-code line. Entering new text automatically inserts spaces between the former end of the line and the newly entered text.
<a href="#">Use “not found” Dialog</a>	Check to have the IDE display a not found message if search for an item in a window, such as Editor, Errors and Warnings, and Class Browser, fails.
<a href="#">Reload externally modified files automatically</a>	Check this option to reload files modified outside the CodeWarrior editor automatically with no alert dialog. The default off.
<a href="#">Balance Flash Delay</a>	Enter the number of ticks to flash a balancing punctuation character. A tick is 1/60 of a second.
<a href="#">Default file format</a>	Select the default end-of-line format used to save files.

## Font & Tabs

The **Font & Tabs** preference panel ([Figure 27.13](#)) provides options for customizing settings used by the editor, including:

- font and font size used in editor windows
- auto indentation and tab size
- tabs on selections and replacing tabs with spaces

[Table 27.14](#) explains the items of this panel.

**Figure 27.13 Font & Tabs Preference Panel**

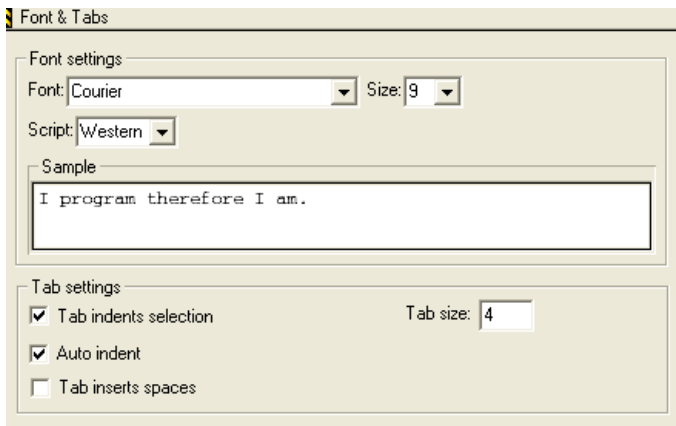

**Table 27.14 Font & Tabs Preference Panel Items**

Item	Explanation
<a href="#">Font</a>	Select the typeface displayed in editor windows.
<a href="#">Size</a>	Select the font size displayed in editor windows.
<a href="#">Script</a> (Windows)	Select the IDE script system. The script system maps keyboard keys to characters of an alphabet.
<a href="#">Tab indents selection</a>	Check to indent each line of selected text after pressing Tab. Clear to replace selected text with a tab character after pressing Tab.
<a href="#">Tab Size</a>	Enter the number of spaces to substitute in place of a tab character. This number applies to the <b>Tab Inserts Spaces</b> option.

## Working with IDE Preferences

### Editor Panels

---

**Table 27.14** Font & Tabs Preference Panel Items (*continued*)

Item	Explanation
<a href="#">Auto Indent</a>	Check to automatically apply the indentation level from the previous line of text to each new line created by pressing Enter or Return.
<a href="#">Tab Inserts Spaces</a>	Check to insert spaces instead of a tab character after pressing Tab. The <b>Tab Size</b> option determines the number of inserted spaces.

---

## Setting the Text Font

To set the text font, follow these steps:

1. Select **Edit > Preferences**.
2. Select the **Font & Tabs** panel in the **Editor** group in the **IDE Preference Panels** list.
3. In the **Font Settings** area of the **IDE Preferences** window, select a font type from the **Font** list box.
4. Save your font in the **IDE Preferences** window.
  - Windows: Click **OK**.
  - Linux/Solaris: Click **Save**.

The foreground text changes to the new font.

---

## Setting the Text Size

To set the text size, follow these steps:

1. Select **Edit > Preferences**.
2. Select the **Font & Tabs** panel in the **Editor** group in the **IDE Preference Panels** list.
3. In the **Font Settings** area of the **IDE Preferences** window, select a text point size (from 2 to 24 points) from the **Size** list box.
4. Save your text size in the **IDE Preferences** window.
  - Windows: Click **OK**.
  - Linux/Solaris: Click **Save**.

The foreground text changes to the new size.

---

## Text Colors

The **Text Colors** preference panel ([Figure 27.14](#)) customizes colors applied to elements of source code displayed in editor windows, such as:

- default foreground and background in editor windows
- standard comments, keywords, and strings in source code
- custom-defined keywords
- browser symbols

[Table 27.15](#) explains the items of this panel.

Default settings provide a simple scheme of at least four source-code colors. If four colors do not provide sufficient detail, modify this preference panel to create more sophisticated color schemes.

**Figure 27.14 Text Colors Preference Panel**

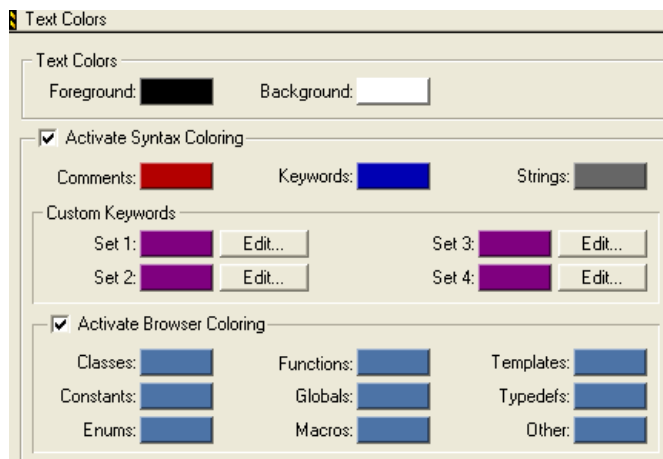

**Table 27.15 Text Colors Preference Panel Items**

Item	Explanation
<a href="#">Foreground</a>	Click the color swatch to display a dialog box. Use the dialog box to set the foreground color used in editor windows for text.
<a href="#">Background</a>	Click the color swatch to set the background color used in editor windows.

## Working with IDE Preferences

### Editor Panels

**Table 27.15 Text Colors Preference Panel Items (*continued*)**

Item	Explanation
<a href="#">Activate Syntax Coloring</a>	Check to apply custom colors to comments, keywords, strings, and custom keywords in text. Clear to use the <b>Foreground</b> color for all text.
<a href="#">Comments</a>	Click the color swatch to set the color used for source-code comments.
<a href="#">Keywords</a>	Click the color swatch to set the color used for source-code language keywords.
<a href="#">Strings</a>	Click the color swatch to set the color used for source-code string literals.
Set 1, Set 2, Set 3, Set 4	Click a color swatch to set the color used for the corresponding custom-keyword set.
Edit	Click to add, modify, or remove keywords from the corresponding custom-keyword set.
<a href="#">Activate Browser Coloring</a>	Check to apply custom colors to browser symbols in text. Clear to use the <b>Foreground</b> color for all text.
Classes	Click the color swatch to set the color used for source-code classes.
Constants	Click the color swatch to set the color used for source-code constants.
Enums	Click the color swatch to set the color used for source-code enumerations.
Functions	Click the color swatch to set the color used for source-code functions.
Globals	Click the color swatch to set the color used for source-code global variables.
Macros	Click the color swatch to set the color used for source-code macros.
Templates	Click the color swatch to set the color used for source-code templates.

Table 27.15 Text Colors Preference Panel Items (*continued*)

Item	Explanation
TypeDefs	Click the color swatch to set the color used for source-code type definitions.
Other	Click the color swatch to set the color used for other symbols not specified in the <b>Activate Browser Coloring</b> section.

---

## Setting the Foreground Text Color

Use the **Foreground Color** option to configure the foreground text color displayed in editor windows.

1. Select **Edit > Preferences**.
2. Select the **Text Colors** panel in the **Editor** group in the **IDE Preference Panels** list.
3. Click the **Foreground** color box to set the editor's foreground color.
4. Pick color.
5. Click **OK** in the **Color Picker** window.
6. Click **OK** or **Save**

The foreground text color changes to the new color.

---

## Setting the Background Text Color

Use the **Background Color** option to configure the background color displayed by all editor windows.

1. Select **Edit > Preferences**.
2. Select the **Text Colors** panel in the **Editor** group in the **IDE Preference Panels** list.
3. Click the **Background** color box to set the editor's background color.
4. Pick color.
5. Click **OK** in the **Color Picker** window.
6. Click **OK** or **Save**

The background text color changes to the new color.

## Activate Syntax and Browser Coloring

Use the **Activate Syntax Coloring** and **Activate Browser Coloring** options to configure the syntax and browser colors that all editor windows display.

1. Select **Edit > Preferences**.
2. Select the **Text Colors** panel in the **Editor** group in the **IDE Preference Panels** list.
3. Check the **Activate Syntax Coloring** or **Activate Browser Coloring** checkbox.
4. Click on the colored box next to the option.
5. Pick color.
6. Click **OK** in the **Color Picker** window.
7. Click **OK** or **Save**

## Debugger Panels

The **Debugger** section of the IDE Preference Panels defines the basic debugger settings assigned to a new project.

The Debugger preference panels available on most IDE hosts include:

- [Display Settings](#)
- [Window Settings](#)
- [Global Settings](#)
- [Remote Connections](#)

## Display Settings

The **Display Settings** preference panel ([Figure 27.15](#)) provides options for customizing various aspects of the IDE Debugger, including:

- assignment of colors to changed variables and watchpoints
- viewing variable types
- displaying local variables
- using decimal values
- sorting functions
- using dynamic objects

[Table 27.16](#) explains the items in this panel.



Figure 27.15 Display Settings Preference Panel

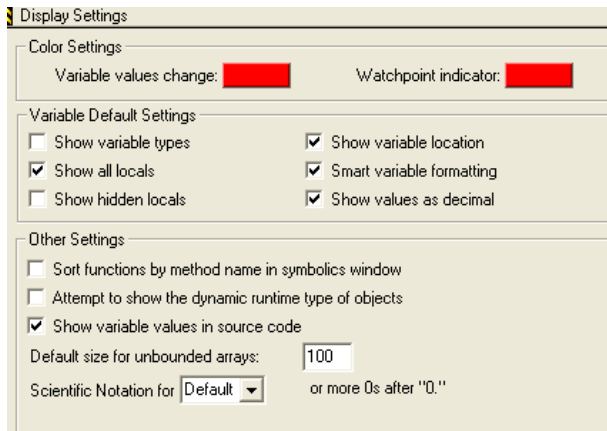

Table 27.16 Display Settings Preference Panel Items

Item	Explanation
<a href="#">Variable values change</a>	Click the color swatch to set the color that indicates a changed variable value.
<a href="#">Watchpoint indicator</a>	Click the color swatch to set the color that indicates a changed watchpoint value.
<a href="#">Show variable types</a>	Check to always show the type associated with each variable.
<a href="#">Show variable location</a>	Check to display the <b>Location</b> column in the Variables pane of the Thread window.
<a href="#">Show all locals</a>	Check to show all local variables. Clear to have the debugger show only variables near the program counter.
<a href="#">Smart Variable Formatting</a>	Controls whether variables in variable windows, panes and expression displays are formatted using entries in XML files located in the VariableFormats support folder; such as the Windows_Formats.xml file.
<a href="#">Show hidden locals</a>	Check to show hidden local variables. A hidden local variable is a variable that is in scope, but is hidden by a variable of the same name in a deeper scope.

## Working with IDE Preferences

### Debugger Panels

**Table 27.16 Display Settings Preference Panel Items (continued)**

Item	Explanation
<a href="#">Show values as decimal</a>	Check to always show decimal values instead of hexadecimal values.
<a href="#">Sort functions by method name in symbolics window</a>	Check to sort functions of the form <code>className::methodName</code> in the Symbolics window by <code>methodName</code> . Clear to sort by <code>className</code> .
<a href="#">Attempt to show the dynamic runtime type of objects</a>	Check to attempt to display the runtime type of the specified language objects. Clear to display the static type.
<a href="#">Show variable values in source code</a>	Check to show variable values in contextual menus in the source code.
<a href="#">Default size for unbounded arrays</a>	Enter the default number of unbounded array elements to display in a View Array window.
Scientific Notation for (1-9) or more 0s after “0.”	Maximum number of zeros after a decimal point in a float value such as 0.034. For example, a value of 2 means 0.00045 will be displayed in scientific notation as 4.5e-4; a value of 3 will be displayed as 0.00045. Does not change value precision, only value display.

## Window Settings

The **Window Settings** preference panel ([Figure 27.16](#)) provides options for customizing how the debugger displays windows during debugging sessions, including non-debugging and project windows. [Table 27.17](#) explains the items of this panel.

**Figure 27.16 Window Settings Preference Panel**

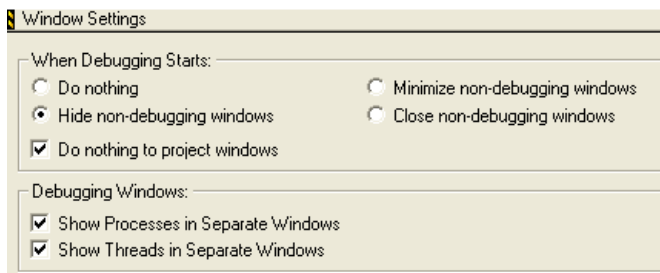

**Table 27.17 Window Settings Preference Panel Items**

Item	Explanation
<a href="#">When Debugging Starts: Do nothing</a>	Select to leave all windows in place when starting a debugging session.
<a href="#">Minimize non-debugging windows</a> (Windows)	Select to minimize all non-debugging windows when starting a debugging session.
<a href="#">Collapse non-debugging windows</a> (Solaris and Linux)	Select to collapse all non-debugging windows when starting a debugging session.
<a href="#">Hide non-debugging windows</a>	Select to hide, but not close, all non-debugging windows when starting a debugging session.
<a href="#">Close non-debugging windows</a>	Select to close all non-debugging windows, except for the active project window, when starting a debugging session.
<a href="#">Do nothing to project windows</a>	Select to prevent the IDE from hiding project windows when starting a debugging session.
<a href="#">Show threads in separate windows</a>	Select to display threads in separate Thread windows. Clear to show all threads in one window. Restart active debugging sessions in order for changes to take effect.
<a href="#">Show processes in separate windows</a>	Select to display processes in separate windows. Clear to show all processes in one window.

## Global Settings

The **Global Settings** preference panel ([Figure 27.17](#)) provides options for customizing various global options for the debugger, including:

- file caching to accelerate debugger sessions
- automatic launch of applications and libraries
- confirmation of attempts to close or quit debugging sessions

[Table 27.18](#) explains the items of this panel.

## Working with IDE Preferences

### Debugger Panels

**Figure 27.17 Global Settings Preference Panel**

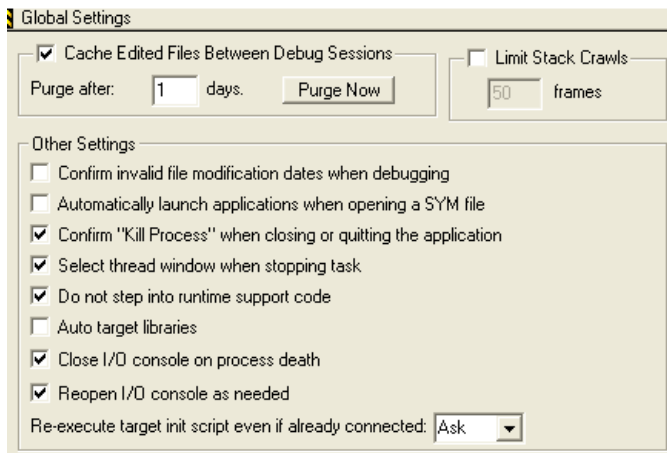

**Table 27.18 Global Settings Preference Panel Items**

Item	Explanation
<a href="#">Cache Edited Files Between Debug Sessions</a>	Check to maintain a cache of modified files between debugging sessions. Use this option to debug through the original source code for files modified since the last build.
<a href="#">Limit Stack Crawls</a>	Check to limit the number of stack frames to display in the Thread window. You can enter the desired number of frames in the <b>frames</b> text box.
<a href="#">Purge after</a>	Enter the number of days after which the IDE deletes its file cache.
<a href="#">Frames</a>	Enter the number of stack frames to display in the Thread window.
<a href="#">Purge Now</a>	Click to delete the file cache maintained by the IDE, freeing memory and disk space.
<a href="#">Confirm invalid file modification dates when debugging</a>	Check to have the IDE display a warning message when debugging a project with mismatched file modification dates.
<a href="#">Automatically launch applications when opening a SYM file</a>	Check to automatically launch the application program associated with an open symbolics file.

**Table 27.18 Global Settings Preference Panel Items (continued)**

Item	Explanation
<a href="#">Confirm “Kill Process” when closing or quitting the application</a>	Check to prompt for confirmation before killing processes upon quitting a debugging session.
<a href="#">Select thread window when stopping task</a>	Check to bring forward the Thread window after the debugger stops tasks
<a href="#">Do not step into runtime support code</a>	Check to have the IDE not step into Main Standard Library (MSL) runtime support code and instead directly step into your own code.
<a href="#">Auto Target Libraries</a>	Check to have the IDE attempt to debug dynamically linked libraries (DLLs) loaded by the target application.
<a href="#">Close I/O console on process death</a>	Check to automatically close the I/O console window, when the process terminates.  If you clear the checkbox, the window remains open until the user explicitly closes it.
<a href="#">Reopen I/O console as needed</a>	Check to have the IDE reopen the I/O console window, when the application writes to the console.
<a href="#">Re-execute target init script even if already connected</a>	Select whether to re-execute the target init script at the start of every debug session, even if the connection is active. Options available are <b>Ask</b> , <b>Never</b> , and <b>Always</b> .

## Remote Connections

The **Remote Connections** preference panel ([Figure 27.18](#)) configures general network settings for remote-debugging connections between the host computer and other computers. [Table 27.19](#) explains the items of this panel.

Use these general settings as the basis for defining more specific connections for individual projects in conjunction with the **Remote Debugging** settings panel. The Target Settings window contains the **Remote Debugging** settings panel.

## Working with IDE Preferences

### Debugger Panels

**Figure 27.18 Remote Connections Preference Panel**

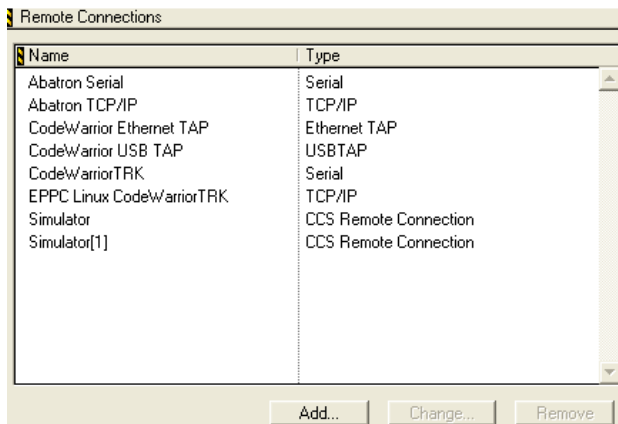

**Table 27.19 Remote Connections Preference Panel Items**

Item	Explanation
Remote Connection list	Displays the name and connection type of all remote connections currently defined.
Add	Click to add a new remote connection to the Remote Connection list.
Change	Click to change the settings of the selected remote connection.
Remove	Click to remove the selected remote connection from the Remote Connection list.

## Adding Remote Connections

Add a remote connection that defines a general network connection between the host computer and a remote computer.

1. Select **Edit > Preferences**.
2. Select the **Remote Connections** panel from the **IDE Preference Panels** list.
3. Click **Add**.

The **New Connection** dialog box appears.

4. Enter the name for the general remote connection.
5. Select from the **Debugger** list box the desired debugger for use with the remote connection.

---

**NOTE** The options available in the New Connection dialog box varies with the kind of debugger selected in the Debugger list box. For information about the options available with the debug connection for your target, see the *Targeting* documentation

---

6. Configure the **Browse in processes window** option as desired:
  - selected—the IDE filters the **Processes** window list and the list of available debuggers for an opened symbolics file. The filter prevents an unavailable remote connection from appearing in either list.
  - cleared—the IDE does not filter the **Processes** window list or the list of available debuggers for an opened symbolics file. Both available and unavailable remote connections appear in the lists.
7. Select from the **Connection Type** list box the desired network protocol for the remote connection.
8. If selected **TCP/IP** in the **Connection Type** list box, enter the Internet Protocol address of the remote computer in the **IP Address** field.
9. Click **OK**.

The IDE adds the new remote connection to the **Remote Connections** list.
10. Click **OK**, **Apply**, or **Save**.

---

## Changing Remote Connections

Change a remote connection to update network-connection information between the host and remote computer.

1. Select **Edit > Preferences**.
2. Select the **Remote Connections** panel from the **IDE Preference Panels** list.
3. Select from the **Remote Connections** list the remote connection that requires modification.
4. Click **Change**.

A dialog box appears with the current network settings for the selected remote connection.
5. If needed, enter a new name for the general remote connection.

## Working with IDE Preferences

### *Debugger Panels*

---

6. If needed, select from the **Debugger** list box a new debugger for use with the remote connection.
7. If needed, toggle the **Browse in processes window** option.
8. If needed, select from the **Connection Type** list box a new network protocol for the remote connection.
9. If needed, enter a new Internet Protocol address for the remote computer.
10. Click **OK**.

The IDE updates the remote connection and displays changes in the **Remote Connections** list.

11. Click **OK**, **Apply**, or **Save**.
- 

## Removing Remote Connections

Remove a remote connection that the project no longer uses.

1. Select **Edit > Preferences**.
2. Select the **Remote Connections** panel from the **IDE Preference Panels** list.
3. Select from the **Remote Connections** list the obsolete remote connection.
4. Click **Remove**.

The IDE updates the **Remote Connections** list.

5. Click **OK**, **Apply**, or **Save**.



# Working with Target Settings

---

This chapter explains core CodeWarrior™ IDE target settings panels and provides basic information on target settings options for the current project's build targets. Consult the *Targeting* documentation for information on platform-specific target settings panels.

This chapter consists of these sections:

- [Target Settings Window](#)
- [Target Panels](#)
- [Code Generation Panels](#)
- [Editor Panels](#)
- [Debugger Panels](#)

## Target Settings Window

The **Target Settings** window ([Figure 28.1](#)) lists settings for the current project's build targets. These target settings supersede global preferences defined in the **IDE Preferences** window. [Table 28.1](#) explains the items of this window.

The Target Settings window lists settings by group:

- **Target**—configures overall build target settings, such as names, browser caching, file mappings, and access paths
- **Language Settings**—configures programming language settings. Consult the *Targeting* documentation for more information about these settings panels
- **Code Generation (Windows)**—configures processor, disassembler, and optimization settings for generating code
- **Linker**—configures linker settings for transforming object code into a final executable file. Consult the *Targeting* documentation for more information about these settings panels.
- **Editor**—configures custom keyword sets and colors
- **Debugger**—configures settings for executable files, program suspension, and remote debugging

## Working with Target Settings

### Target Settings Window

- **Command-Line Extras (Linux/Solaris)**—configure environmental variables for user applications and define custom tool commands (if necessary)

**Figure 28.1 Target Settings Window**

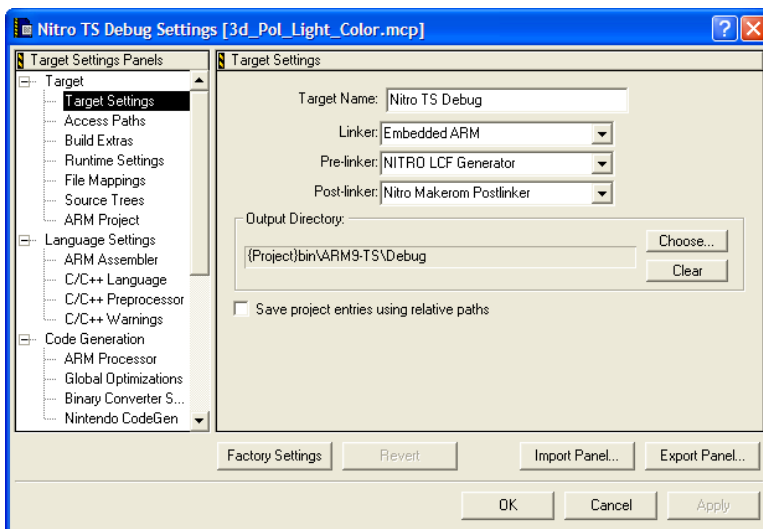

**Table 28.1 Target Settings Window Items**

Item	Explanation
Target Settings Panels list	Lists settings panels, organized in groups. Click the hierarchical control next to a group name to show or hide a list of individual settings panels.
Settings panel	Shows options for the selected item in the <b>Target Settings Panels</b> list.
<a href="#">Factory Settings</a>	Click to restore the default options for the current settings panel.
<a href="#">Revert Panel</a>	Click to restore the most recently saved options for the current settings panel.
<a href="#">Export Panel</a>	Click to save the settings in the current panel to an XML file.
<a href="#">Import Panel</a>	Click to open an XML file containing settings for the current panel and import them into the panel.

Table 28.1 Target Settings Window Items (*continued*)

Item	Explanation
OK (Windows)	Click to save modifications to all settings panels and close the window.
Cancel (Windows)	Click to discard modifications to all settings panels and close the window.
Apply (Windows)	Click to confirm modifications to all settings panels.
Save (Solaris and Linux)	Click to save modifications to all settings panels.

## Opening the Target Settings Window

Use the **Target Settings** window to modify build target options for the current project. Select **Edit** > *targetname* **Settings** to display the **Target Settings** window.

## Target Panels

The **Target** group of the Target Settings Panels defines general target settings for a new project.

The panels available on most of the IDE hosts include:

- [Target Settings](#)
- [Access Paths](#)
- [Build Extras](#)
- [Runtime Settings](#)
- [File Mappings](#)
- [Source Trees](#)

## Target Settings

The **Target Settings** panel ([Figure 28.2](#)) provides options for:

- setting the name of the current build target
- setting the linker, pre-linker, and post-linker for the build target
- specifying the project output directory for the final output file

## Working with Target Settings

### Target Panels

[Table 28.2](#) explains the items of this panel.

**Figure 28.2 Target Settings Panel**

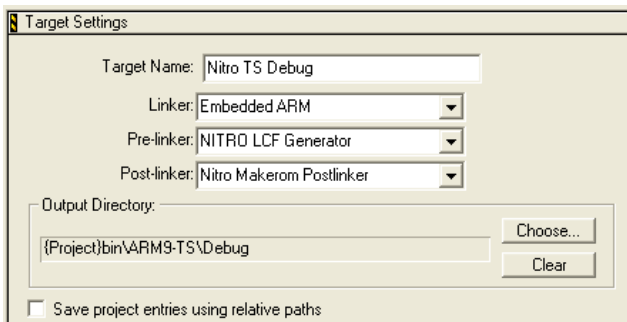

**Table 28.2 Target Settings Panel Items**

Item	Explanation
<a href="#">Target Name</a>	Enter a name (26 or fewer characters) for the selected build target. The build target appears with the same name in the Project window.
<a href="#">Linker</a>	Select the linker to use on the current build target.
<a href="#">Pre-linker</a>	Select the pre-linker to use on the current build target.
<a href="#">Post-linker</a>	Select the post-linker to use on the current build target.
<a href="#">Output Directory</a>	Shows the location where the IDE creates the output binary file. Click <b>Choose</b> to change this location.
<b>Choose</b>	Click to select the directory in which the IDE saves the output binary file.
<b>Clear</b>	Click to delete the current <b>Output Directory</b> path.
<a href="#">Save project entries using relative paths</a>	Select to save project file entries using a relative path from a defined access path. This option is helpful if the project has multiple files with the same name.

## Access Paths

The **Access Paths** settings panel ([Figure 28.3](#)) defines the search paths for locating and accessing a build target’s system files and header files. [Table 28.3](#) explains the items of this panel.

**NOTE** The Windows version of the Access Paths settings panel displays either User Paths or System Paths, depending on the selected option button. The Solaris and Linux versions of the Access Paths settings panel display both User Paths and System Paths.

**Figure 28.3 Access Paths Settings Panel**

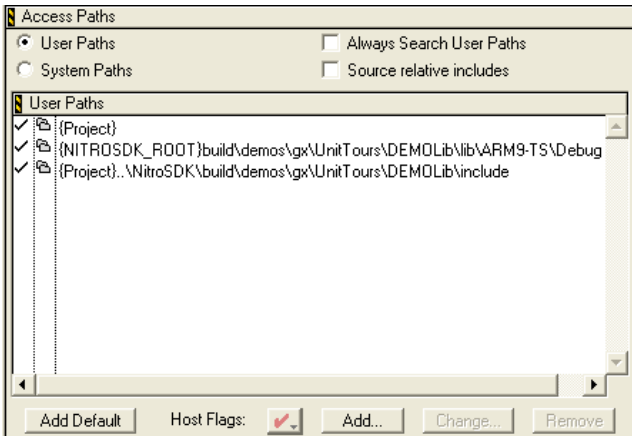

**Table 28.3 Access Paths Settings Panel Items**

Item	Explanation
<a href="#">Always Search User Paths</a>	Check to treat <code>#include &lt;...&gt;</code> statements the same as <code>#include "..."</code> statements.
<a href="#">Source relative includes</a>	Check to search for dependent files in the same location as the source file. If the dependent file is not found in this location, specified User and System paths are searched. If this option is enabled, the Always Search User Paths should also be enabled.

## Working with Target Settings

### Target Panels

**Table 28.3 Access Paths Settings Panel Items (continued)**

Item	Explanation
<a href="#">User Paths</a>	The <b>User Paths</b> list shows currently defined user-level access paths searched by #include "... " statements.
<a href="#">System Paths</a>	The <b>System Paths</b> list shows currently defined system-level access paths searched by #include <...> statements.
<a href="#">Add Default</a>	Click to restore the default user- and system-level access paths.
<a href="#">Host Flags</a> list pop-up	Select the host platforms that can use the selected access path.
Add	Click to add a user- or system-level access path.
Change	Click to modify the selected user- or system-level access path.
Remove	Click to remove the selected user- or system-level access path.

The **User Paths** and **System Paths** lists display columns with status icons for each access path. There are different types of access paths. [Table 28.4](#) explains these items.

**Table 28.4 User Paths, System Paths List Columns**

Name	Icon	Explanation
Search status	✓	A checkmark icon indicates an active access path that the IDE searches.
		No checkmark icon indicates an inactive access path that the IDE does not search.

**Table 28.4 User Paths, System Paths List Columns (*continued*)**

Name	Icon	Explanation
Recursive search		A folder icon indicates that the IDE recursively searches subdirectories of the access path.
		No folder icon indicates that the IDE does not recursively search the access path.
Access path		<p>Shows the full access path to the selected directory. Access paths have these types:</p> <ul style="list-style-type: none"> <li>• Absolute—the complete path, from the root level of the hard drive to the directory, including all intermediate directories</li> <li>• Project—the path from the project file relative to the designated directory</li> <li>• CodeWarrior—the path from the CodeWarrior IDE relative to the designated directory</li> <li>• System—the path from the operating system's base directory relative to the designated directory</li> <li>• Source tree—the path from a user-defined source tree relative to the designated directory</li> </ul>

## Build Extras

The **Build Extras** settings panel ([Figure 28.4](#)) contains options that define how the CodeWarrior IDE builds a project. [Table 28.5](#) explains the items of this panel.

## Working with Target Settings

### Target Panels

**Figure 28.4 Build Extras Settings Panel**

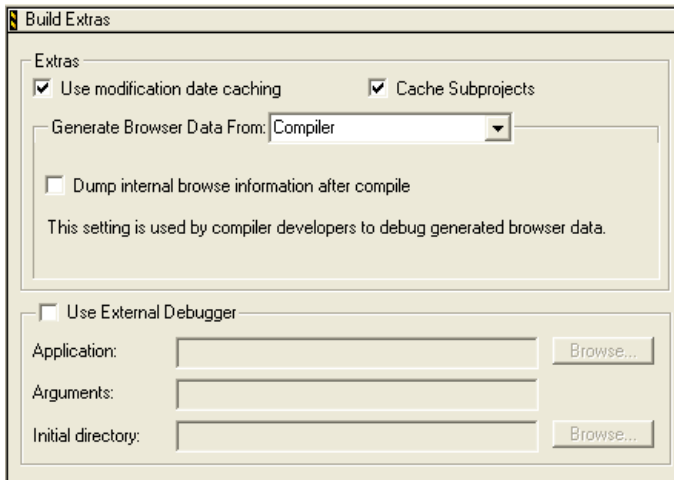

**Table 28.5 Build Extras Settings Panel Items**

Item	Explanation
<a href="#">Use modification date caching</a>	<p>Check to have the IDE cache modification date information and use that information each time it builds a target. Builds are faster if file modification dates are cached.</p> <p>Note that it is recommended to uncheck this option if you are using an external editor or using mounted directories.</p> <p>For one-time changes to files (for example, those updated by a VCS tool outside of the IDE or editing a file with an external editor), you should check the modification date by clicking the “Synchronize Modification Dates” button in the project window toolbar.</p>
<a href="#">Cache Subprojects</a>	Check to improve multi-project updating and linking speed.
<a href="#">Generate Browser Data From</a>	Select to enable or disable browser data generation. You can generate browser data from the compiler or the language parser



**Table 28.5 Build Extras Settings Panel Items (continued)**

Item	Explanation
<a href="#">Dump internal browse information after compile</a>	Check to have the IDE dump raw browser information for viewing. This checkbox appears when you select <b>Compiler</b> from the <a href="#">Generate Browser Data From</a> list box.
Prefix file	Enter the path to your project's prefix file. This text box appears when you select <b>Language Parser</b> from the <a href="#">Generate Browser Data From</a> list box.
Macro file	Enter the path to your project's macro file. This text box appears when you select <b>Language Parser</b> from the <a href="#">Generate Browser Data From</a> list box.
<a href="#">Use External Debugger</a>	Check to use an external debugger instead of the CodeWarrior debugger.
<a href="#">Application</a>	Click <b>Browse</b> to select the external debugger application. Alternatively, enter the path to the external debugger.
<a href="#">Arguments</a>	Enter any program arguments to pass to the external debugger when the IDE transfers control.
<a href="#">Initial directory</a>	Click <b>Browse</b> to select an initial directory for the external debugger. Alternatively, enter the path to the initial directory.

## Runtime Settings

The **Runtime Settings** panel ([Figure 28.5](#)) specifies a debugging application for non-executable files. Dynamic linked libraries (DLLs), shared libraries, and code resources are sample non-executable files. [Table 28.6](#) explains the items of this panel.

## Working with Target Settings

### Target Panels

**Figure 28.5 Runtime Settings Panel**

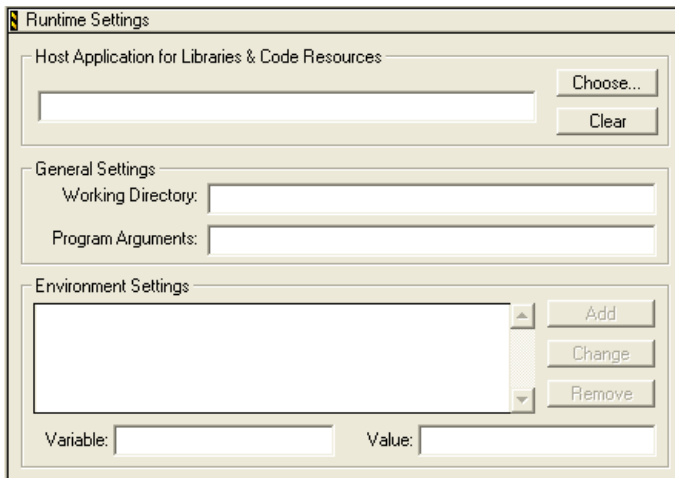

**Table 28.6 Runtime Settings Panel Items**

Item	Explanation
<a href="#">Host Application for Libraries &amp; Code Resources</a>	Click <b>Choose</b> to select the program for debugging non-executable files. Alternatively, enter the path to the application program. Click <b>Clear</b> to delete the current field entry.
<a href="#">Working Directory</a>	Enter the path to a directory to use for debugging the non-executable files. Leave this field blank to use the same directory that contains the non-executable files.
<a href="#">Arguments</a>	Enter a command line of program arguments to pass to the host application when the IDE transfers control.
<a href="#">Environment Settings</a>	Lists the environment variables that have been added to the build target.
Add	Click to add the current <b>Variable</b> and <b>Value</b> pair to the Environment Settings list.
Change	Click to replace the selected entry in the Environment Settings list with the current <b>Variable</b> and <b>Value</b> pair.
Remove	Click to delete the selected environment variable from the Environment Settings list.

**Table 28.6 Runtime Settings Panel Items (continued)**

Item	Explanation
<a href="#">Variable</a>	Enter a name for the environment variable. This name pairs with the information in the <b>Value</b> field.
<a href="#">Value</a>	Enter a value for the environment variable. This value pairs with the information in the <b>Variable</b> field.

## File Mappings

The **File Mappings** settings panel ([Figure 28.6](#)) associates filename extensions with a CodeWarrior plug-in compiler. These associations determine whether the IDE recognizes a source file by its filename extension or file type. Use this settings panel to add, change, and remove file mappings. [Table 28.7](#) explains the items of this panel.



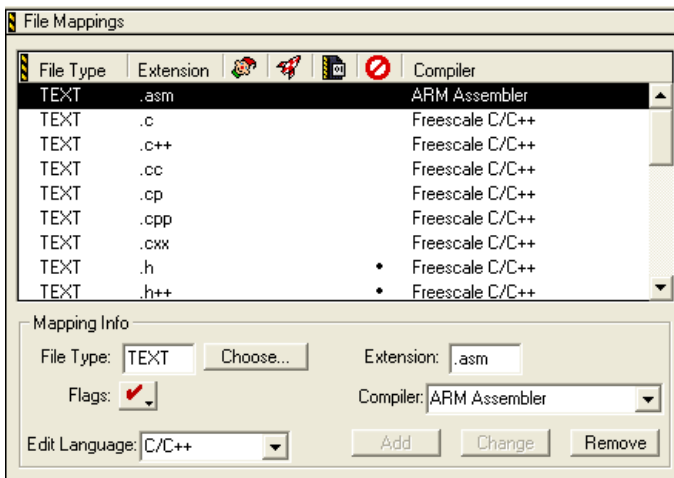

**Figure 28.6 File Mappings Settings Panel**



## Working with Target Settings

### Target Panels

**Table 28.7 File Mappings Settings Panel Items**

Item	Icon	Explanation
File Mappings list		Displays a list of currently defined mappings between filename extensions and plug-in compilers.
<a href="#">File Type</a>		Enter a file type (such as <code>TEXT</code> ) for the file mapping. Alternatively, click <b>Choose</b> to set the file type by selecting an example file. This file type also appears in the corresponding column of the File Mappings list.
<a href="#">Extension</a>		Enter the filename extension (such as <code>.cpp</code> ) for the file mapping. This filename extension also appears in the corresponding column of the File Mappings list.
Resource File flag		A bullet in this column denotes a resource file. The IDE includes these resource files when building the final output file. Use the <b>Flags</b> pop-up menu to toggle this flag.
Launchable flag		A bullet in this column denotes a launchable file. The IDE opens launchable files with the application that created them. Double-click launchable files from the Project window. Use the <b>Flags</b> pop-up menu to toggle this flag.
Precompiled File flag		A bullet in this column denotes a precompiled file. The IDE builds precompiled files before building other files. Use the <b>Flags</b> pop-up menu to toggle this flag.
Ignored By Make flag		A bullet in this column denotes a file ignored by the compiler during builds. For example, use this option to ignore text ( <code>.txt</code> ) files or document ( <code>.doc</code> ) files. Use the <b>Flags</b> pop-up menu to toggle this flag.
<a href="#">Compiler</a>		Select from this list box the plug-in compiler to associate with the selected file mapping. This compiler selection also appears in the corresponding column of the File Mappings list.
Flags		Select from this pop-up menu the desired flags for the selected file mapping. A checkmark indicates an active flag. Bullets appear in the corresponding columns of the File Mappings list to reflect flag states.

**Table 28.7 File Mappings Settings Panel Items (continued)**

Item	Icon	Explanation
<a href="#">Edit Language</a>		Select from this list box the desired language to associate with the selected file mapping. The IDE applies the appropriate syntax coloring for the selected language.
Add		Click to add the current File Type, Extension, Flags, Compiler, and Edit Language entries to the File Mappings list.
Change		Click to change the selected item in the File Mappings list to reflect the current File Type, Extension, Flags, Compiler, and Edit Language entries.
Remove		Click to remove the selected item in the File Mappings list.

## Source Trees

The **Source Trees** settings panel in the Target Settings window defines project-specific root paths. These project-specific paths override the global root paths defined in the **Source Trees** preference panel of the IDE Preferences window. Refer to [Source Trees](#) for information on adding, changing, or removing paths.

## Code Generation Panels

The **Code Generation** group of the Target Settings Panels provides a single core panel for configuring optimization routines. Consult the *Targeting* documentation for more information about platform-specific settings panels.

## Global Optimizations

The **Global Optimizations** settings panel ([Figure 28.7](#)) configures how the compiler optimizes object code. All optimization routines rearrange object code without affecting its logical execution sequence. [Table 28.8](#) explains the items of this panel

---

**NOTE** Always debug programs with optimization routines disabled. The IDE does not provide source views of optimized code.

## Working with Target Settings

### Code Generation Panels

The Global Optimizations panel is specific to the CodeWarrior compilers. This panel is not appropriate for the Linux-hosted IDE, which uses gcc.

**Figure 28.7 Global Optimizations Settings Panel**

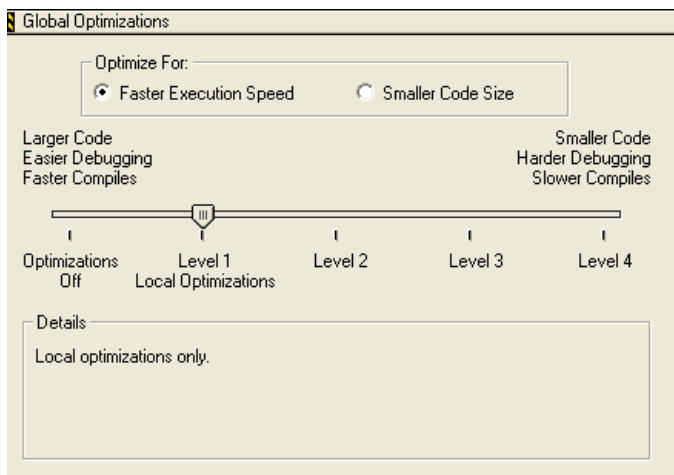

**Table 28.8 Global Optimizations Settings Panel Items**

Item	Explanation
Faster Execution Speed	Select to favor optimization routines that increase the execution speed of the final object code, at the expense of larger code size.
Smaller Code Size	Select to favor optimization routines that reduce the size of the final object code, at the expense of slower execution speed.
Optimization Level slider	Move to the desired optimization level. The IDE applies more optimization routines at higher optimization levels. The <b>Details</b> field lists the active optimization routines.

The **Details** field lists individual optimization routines applied at the selected optimization level. [Table 28.9](#) explains these optimizations and their availability at certain optimization levels.

**Table 28.9 Optimization Routines**

<b>Optimization Routine</b>	<b>Explanation</b>	<b>Optimization Level</b>
Global Register Allocation or Global Register Allocation Only for Temporary Values	Stores working values of heavily used variables in registers instead of memory.	1, 2, 3, 4
Dead Code Elimination	Removes statements never logically executed or referred to by other statements.	1, 2, 3, 4
Branch Optimizations	Merges and restructures portions of the intermediate code translation in order to reduce branch instructions.	1, 2, 3, 4
Arithmetic Operations	Replaces intensive computational instructions with faster equivalent instructions that produce the same result.	1, 2, 3, 4
Expression Simplification	Replaces complex arithmetic expressions with simplified equivalent expressions.	1, 2, 3, 4
Common Subexpression Elimination	Replaces redundant expressions with a single expression.	2, 3, 4
Copy Propagation or Copy and Expression Propagation	Replaces multiple occurrences of one variable with a single occurrence.	2, 3, 4
Peephole Optimization	Applies local optimization routines to small sections of code.	2, 3, 4
Dead Store Elimination	Removes assignments to a variable that goes unused before being reassigned again.	3, 4
Live Range Splitting	Reduces variable lifetimes to achieve optimal allocation. Shorter variable lifetimes reduce register spilling.	3, 4

## Working with Target Settings

### Editor Panels

**Table 28.9 Optimization Routines (continued)**

Optimization Routine	Explanation	Optimization Level
Loop-Invariant Code Motion	Moves static computations outside of a loop	3, 4
Strength Reduction	Inside loops, replaces multiplication instructions with addition instructions.	3, 4
Loop Transformations	Reorganizes loop object code in order to reduce setup and completion-test overhead.	3, 4
Loop Unrolling or Loop Unrolling (Opt for Speed Only)	Duplicates code inside a loop in order to spread branch and completion-test overhead over more operations.	3, 4
Vectorization	For processors that support vector optimizations, translates computations with code-loop arrays into equivalent vector instructions.	3, 4
Lifetime Based Register Allocation or Register Coloring	In a particular routine, uses the same processor register to store different variables, as long as no statement uses those variables simultaneously.	3, 4
Instruction Scheduling	Rearranges the instruction sequence to reduce conflicts among registers and processor resources.	2, 3, 4
Repeated	Iterates the optimization routines listed between { * and * }.	4

## Editor Panels

The **Editor** group of the Target Settings Panels provides a single core panel for configuring custom keywords within a project.



## Custom Keywords

The **Custom Keywords** settings panel ([Figure 28.8](#)) configures as many as four keyword sets, each with a list of keywords and syntax coloring for a project. These project-specific settings supersede the global settings defined in the **Text Colors** preference panel of the IDE Preferences window. [Table 28.10](#) explains the items of this panel.

**Figure 28.8 Custom Keywords Settings Panel**

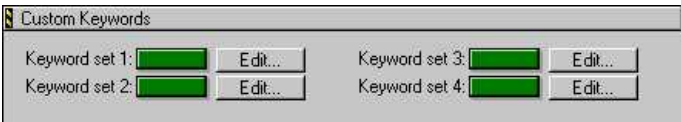

**Table 28.10 Custom Keywords Settings Panel Items**

Item	Explanation
Keyword set 1, Keyword set 2, Keyword set 3, Keyword set 4	Click a color swatch to set the color used for the corresponding custom-keyword set.
Edit	Click to add, modify, or remove keywords from the corresponding custom-keyword set.

### Adding a Keyword to a Keyword Set

To add a keyword to a keyword set, follow these steps:

1. Click **Edit** next to the desired keyword set.  
 A dialog box appears. This dialog box lists the current collection of keywords in the keyword set.
2. Enter the new keyword into the field at the top of the dialog box.
3. Click **Add**.  
 The new keyword appears in the keyword list.
4. Check **Case Sensitive** as desired.  
 When checked, the IDE treats the case of each keyword in the keyword set as significant. When cleared, the IDE ignores the case of each keyword in the keyword set.

## Working with Target Settings

### Debugger Panels

---

5. Click **Done**.

The IDE saves the modified keyword set.

---

## Removing a Keyword from a Keyword Set

To remove a keyword from a keyword set, follow these steps:

1. Click **Edit** next to the desired keyword set.  
A dialog box appears. This dialog box lists the current collection of keywords in the keyword set.
2. Select the obsolete keyword in the Custom Keywords list.
3. Press the delete key for your platform.
  - Windows, Solaris, and Linux: Backspace
4. Click **Done**.

The IDE saves the modified keyword set.

## Debugger Panels

The **Debugger** group of the Target Settings Panels defines general debugger settings for the project. Consult the *Targeting* documentation for more information about platform-specific settings panels.

The Debugger panels available on most IDE hosts include:

- [Other Executables](#)
- [Debugger Settings](#)
- [Remote Debugging](#)

## Other Executables

The **Other Executables** settings panel ([Figure 28.9](#)) configures additional executable files for the IDE to debug together with the current build target. [Table 28.11](#) explains the items of this panel.

Figure 28.9 Other Executables Settings Panel

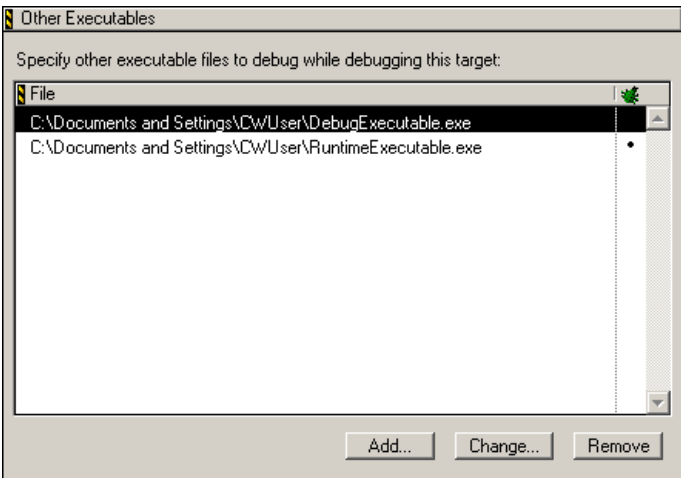

Table 28.11 Other Executables Settings Panel Items

Item	Icon	Explanation
File list		Lists executable files that the IDE can debug together with the current build target.
Debug column		Click in this column to toggle debugging of the corresponding executable file.
Add		Click to select an executable file to add to the File list.
Change		Click to change the selected entry in the File list.
Remove		Click to remove the selected entry in the File list.

### Adding an Executable File to the File List

To add an executable file to the File list, follow these steps:

1. Click **Add**.  
The **Debug Additional Executable** dialog box appears.

## Working with Target Settings

### Debugger Panels

---

2. Enter in the **File Location** field the path to the executable file.

Alternatively, click **Choose** to display a dialog box. Use the dialog box to select the executable file. The path to the selected executable file appears in the **File Location** field.

3. Check **Download file during remote debugging** as desired.

When checked, the IDE downloads the executable file from a remote computer during the debugging session. Enter the path to the remote file. Alternatively, click **Choose** to select the file. Click **Clear** to delete the current entry.

If this checkbox is not checked, the debugger does not upload the specified executable to the target when you start a debug session. However, the debugger still uses its symbolic information during the debug session, allowing you to debug the executable in the IDE.

You may choose to uncheck this checkbox in following conditions:

- To debug a large executable that does not change very often and as a result, does not need to be uploaded to the target often.
- To debug other executable ELF's representing code that has been flashed, burnt into ROM, or otherwise previously loaded into memory. You may not want to load them into memory. For targets with RTOSes or real OSes, these may represent code which is loaded on demand by the OS. In this case, you definitely do not want to load this code into memory, but you do want to identify it so that the debugger can load the symbolic information from the ELF and identify and debug it when it is loaded.

4. Check **Debug merged executable** as desired.

When checked, the IDE debugs an executable file that merged with the project output. Enter the path to the original executable file (prior to merging). Alternatively, click **Choose** to select the file. Click **Clear** to delete the current entry.

5. Click **Done**.

The IDE adds the executable file to the File list.

---

## Changing an Executable File in the File List

To change an executable file in the File list, follow these steps:

1. Select the desired path.
2. Click **Change**.

The **Debug Additional Executable** dialog box appears.

3. Modify the **File Location** field as desired.
  4. Modify the **Download file during remote debugging** checkbox as desired.
-

5. Modify the **Debug merged executable** checkbox as desired.
6. Click **Done**.  
The IDE modifies the executable file.

## Removing an Executable File from the File List

To remove an executable file from the File list, follow these steps:

1. Select the obsolete path.
2. Click **Remove**.

The IDE removes the executable file from the File list.

## Debugger Settings

The **Debugger Settings** panel ([Figure 28.10](#)) configures activity logs, data-update intervals, and other debugger-related options. [Table 28.12](#) explains the items of this panel.

**Figure 28.10 Debugger Settings Panel**

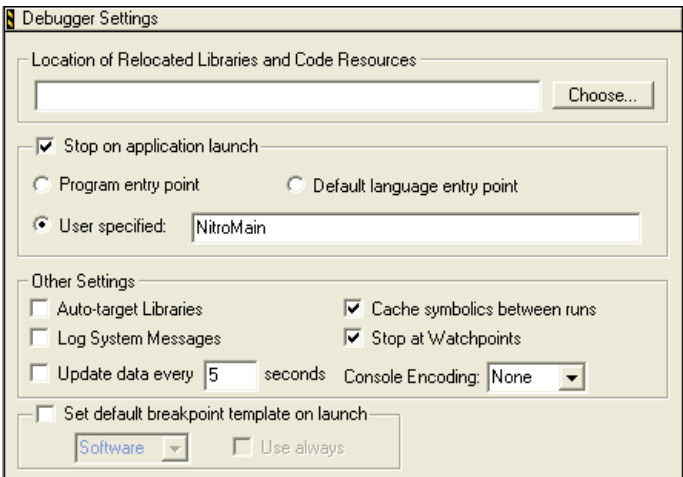

## Working with Target Settings

### Debugger Panels

**Table 28.12 Debugger Settings Panel Items**

Item	Explanation
<a href="#">Location of Relocated Libraries and Code Resources</a>	Enter the path to code resources or relocated libraries required for debugging the project. Alternatively, click <b>Choose</b> to select the required files.
<a href="#">Stop on application launch</a>	Check to halt program execution at the beginning of a debugging session. Select the desired stop point: <b>Program entry point</b> , <b>Default language entry point</b> , or <b>User specified</b> .
<a href="#">Program entry point</a>	Select to halt program execution upon entering the program.
<a href="#">Default language entry point</a>	Select to halt program execution upon entering a default point defined by the programming language.
User specified	Select to halt program execution at a specified function or address. Enter the desired function name or address in the corresponding field. If you enter an address, ensure that it is correct and within your program.
Auto-target Libraries	Check to debug dynamically linked libraries (DLLs) loaded by the target application, at the expense of slower performance.
<a href="#">Cache symbolics between runs</a>	Check to have the IDE cache the symbolics information it generates for a project. Clear to have the IDE discard the information after each debugging session ends.
<a href="#">Log System Messages</a>	Check to log all system messages to a Log window.
<a href="#">Stop at Watchpoints</a>	Check to halt program execution at a watchpoint. Clear to report watchpoint in a message window.
<a href="#">Update data every n seconds</a>	Enter the number of seconds <i>n</i> to wait before updating the data displayed in debugging-session windows.

## Remote Debugging

The **Remote Debugging** settings panel ([Figure 28.11](#)) configures target-specific network settings for remote-debugging connections between the host computer and other

computers. Use this target-specific panel to build on the general connections defined in the **Remote Connections** panel of the IDE Preferences window. [Table 28.13](#) explains the items of this panel.

**Figure 28.11 Remote Debugging Settings Panel**

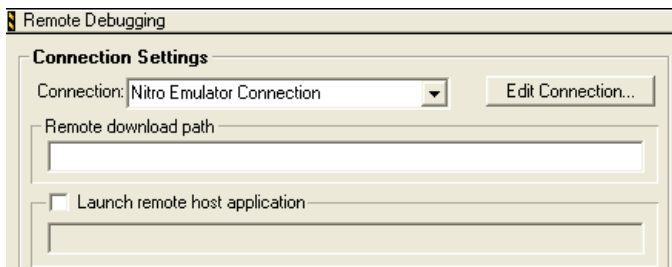

**Table 28.13 Remote Debugging Settings Panel Items**

Item	Explanation
<a href="#">Enable remote debugging</a>	Select to define (for the current build target) a remote-debugging connection in terms of a general connection.
Connection	Select the desired general connection to use as the basis for the target-specific connection.
<a href="#">Remote download path</a>	Enter the path to the directory in which to store downloaded files.
<a href="#">Launch remote host application</a>	Check to launch an application on the remote computer to serve as a host application. Enter the path to the remote application.



## **Working with Target Settings**

*Debugger Panels*

---



# Preference and Target Settings Options

---

Use this chapter to look up CodeWarrior™ IDE preference panel or target setting options and learn more about their capabilities. Option names are arranged in alphabetical order.

---

**NOTE** This chapter covers options for the core IDE preference or target setting panels described in this manual.

---

---

## A

### Activate Browser Coloring

Select this option to activate coloring of browser symbols in editor windows. Clear the option to apply the default text color to all symbols. Click the color swatch next to a symbol to modify its color.

### Activate Syntax Coloring

Select this option to activate coloring of Comments, Keywords, Strings, and Custom Keyword Sets symbols in editor windows. Clear the option to apply the default text color to all symbols. Click the color swatch next to a symbol to modify its color.

### Add Default

Click this button to restore the default user path or system path to the Access Paths panel.

### Always Search User Paths

This option controls the search criteria the IDE uses to find system and user files.

- selected—the IDE treats searching for system files (such as `#include <...>`) the same as user files (`#include "..."`).

## Preference and Target Settings Options

---

- disabled—the IDE treats system paths differently from user paths.

### Application

In this field enter the path to the external debugger that the IDE uses in place of the CodeWarrior debugger. Alternatively, click **Browse** to open a dialog box. Use the dialog box to select the external debugger.

### Arguments

In this field enter command-line arguments to pass to the external debugger at the beginning of a debugging session.

### Attempt to show the dynamic runtime type of objects

Select this option to display runtime types for C++, Object Pascal, and SOM objects. Clear the option to display static types.

### Auto Indent

Select this option to apply automatically the same indentation as the previous line for each new line of text created by pressing Enter or Return. Clear the option to always return to the left margin for each new line of text.

### Auto Target Libraries

Select this option to have the IDE attempt to debug dynamically linked libraries (DLLs) loaded by the target application. The IDE debugs the DLLs that have symbolics information.

This option applies to non-project debugging sessions, such as debugging an attached process.

---

**NOTE** Selecting this option may slow IDE performance. Clear the option to improve speed.

---

### Automatic Invocation

Select this option to have the Code Completion window automatically open after typing specific programming-language characters in the active editor window. Clear the option to manually open the Code Completion window.

The specific characters that trigger opening of the Code Completion window depend on the programming language that you use. For example, typing a period after a Java class opens the Code Completion window, allowing you to complete the class invocation.

You can change the time it takes for the Code Completion window to appear after you type a trigger character. If you perform any activity during this delay time, the Code Completion window is canceled.

See also:

- [Code Completion Delay](#)

## Automatically launch applications when opening a SYM file

Select this option to launch an application associated with an open symbolics file. The IDE sets an implicit breakpoint at the main entry point of the application. Clear the option to open the symbolics file without launching the associated application.

[Table 29.1](#) explains how to skip launching the target program

**Table 29.1 Bypass Launching the Target Program**

On this host...	Do this...
Windows	Press Alt while the IDE opens the symbolics file.
Solaris	Press Alt while the IDE opens the symbolics file.
Linux	Press Alt while the IDE opens the symbolics file.

## B

### Background

Click this color swatch to configure the background color of editor windows.

### Balance Flash Delay

In this field enter the time, in ticks, to highlight a matching punctuation character during a **Balance while typing** check. Each *tick* represents 1/60th of a second (16.67 milliseconds).

Sample tick values include:

- 0 (zero)—disables balance flashing

## Preference and Target Settings Options

---

- 30—the default flash value (1/2 of a second)
- 999—the maximum-flash delay value

### Balance while typing

Select this option to have the editor check for balanced parentheses, brackets, and braces in editor windows. For each closing parenthesis, bracket, or brace, the editor attempts to find the opening counterpart.

The IDE behaves differently, depending on whether it finds the counterpart:

- Found—the editor window scrolls to display the matching character, then returns to the insertion point. The **Balance Flash Delay** option determines how long the editor displays the matching character.
- Not found—the IDE beeps.

### Browser Commands

Select this option to add **Browser** menu commands to contextual menus. Clear the option to remove commands from the contextual menus.

### Browser Path

In this field enter a path to the browser to use for viewing IDE online help. The Netscape Navigator® browser is the default application. The `PATH` environment variable specifies the path to the browser.

To change the default setting, or if the IDE cannot find Netscape Navigator, in the **Browser Path** field enter a path to an alternate browser. Alternatively, click **Set** to select the path.

### Build before running

Choose from this pop-up menu the way in which the IDE handles project builds before running the compiled application:

- Always—always build projects before running them.
- Never—never build projects before running them.
- Ask—ask each time how to proceed.

## C

## Cache Edited Files Between Debug Sessions

Select this option to maintain a cache of edited files between debugging sessions. Use this option to debug through the original source code for files modified since the last build.

In the **Purge after** field, enter the number of days after which to delete the file cache. Click **Purge Now** to delete the current cache.

See also:

- [Purge after](#)
- [Purge Now](#)

## Cache Subprojects

Use this option to improve multi-project updating and linking.

- **selected**—the IDE increases its memory requirements in order to generate symbolics information for both the build targets and the subprojects within each build target.
- **cleared**—the IDE does not increase its memory requirements and does not generate symbolics information.

## Cache symbolics between runs

Select this option to have the IDE maintain a cache of symbolics information generated for the project. The IDE refers to this cached symbolics information during subsequent debugging sessions. The cache improves IDE performance. Clear the option to force the IDE to discard the symbolics information at the end of each debugging session.

## Case sensitive

Select this option to have the IDE consider case when completing code. Clear the option to have the IDE ignore case.

The IDE can determine possible symbol matches according to case. For example, if you clear the **Case sensitive** option and type `str` in the active editor window, the IDE displays both `string` and `String` as possible matches. Selecting the option causes the IDE to display only `string` as a possible match.

### Close I/O console on process death

Check the **Close I/O console on process death** checkbox to close the I/O console window, when a process terminates. If you clear the checkbox, the window remains open until the user explicitly closes it.

### Close non-debugging windows

Select this option to close non-debugging windows, except for the active project window, when starting a debugging session. At the end of the debugging session, the IDE automatically re-opens the closed windows.

### Code Completion Delay

In this field enter the number of ticks to have the IDE wait from the time you type a trigger character to the time the Code Completion window opens. A tick is 1/60 of a second.

Performing any activity during this delay time cancels opening of the Code Completion window.

See also:

- [Automatic Invocation](#)

### Collapse non-debugging windows

Select this option to collapse non-debugging windows when starting a debugging session. At the end of the debugging session, the IDE automatically restores the collapsed windows.

### Comments

Select the **Activate Syntax Coloring** option in order to configure this option. Use this option to configure the color of C, C++, and Java comments displayed in editor windows. The IDE then uses the chosen color for comments placed between `/*` and `*/` or from `//` to the end of a line.

Click the color swatch next to Comments to set the color.

### Compiler

Choose from this list pop-up the desired compiler for the selected **File Type** in the **File Mappings** list. Select **None** to not associate the selected file type with any compiler.

## Compiler thread stack

In this field enter the maximum kilobytes of stack size for the IDE to allocate to compiling and linking thread support.

The IDE threads all build processes, with compiling and linking occurring on a thread separate from the main application thread. This setting controls the compiler-thread stack size.

To avoid frequent compiler crashes, such as when building very large or complex projects, increase the default compiler-thread-stack size.

## Confirm invalid file modification dates when debugging

Select this option to keep track of source-file modification dates in a project. The IDE displays a warning message if the modification dates do not match. The message warns of possible discrepancies between object code and source code. Clear the option to prevent the IDE from displaying the warning message.

## Confirm “Kill Process” when closing or quitting the application

Select the **Confirm “Kill Process” when closing or quitting the application** checkbox to have the IDE prompt for confirmation before killing processes upon closing the Thread window or quitting the IDE. Clear the option to kill processes without prompting.

## Context popup delay

In this field enter the minimum time, in ticks, to hold down the mouse button before IDE contextual menus appear. Each *tick* represents 1/60 of a second (16.67 milliseconds).

Sample tick values include:

- 0 (zero)—disables appearance of contextual menus
- 40—default popup delay value (2/3 of a second)
- 240—maximum popup delay value

### D

## Debugger Commands

Select this option to add **Debug** menu commands to IDE contextual menus. Clear the option to remove commands from the contextual menus.

## Default file format

Choose from this list pop-up the default end-of-line (EOL) conventions used by the IDE to save files:

- DOS: <LF><CR>
- UNIX: <LF>

## Default language entry point

Select this option to halt program execution upon entering a default point defined by the programming language. For example, C++ defines the `main()` function as the default point.

## Default size for unbounded arrays

Enter in this field the default number of elements to display in **View Array** windows for unbounded arrays.

## Disable third party COM plug-ins

Select this option to prevent the IDE from loading third-party Component Object Model (COM) plug-ins. Clear the option to have the IDE load the plug-ins at start-up time.

Use this option to help troubleshoot problems with the IDE. If the problem goes away after disabling the plug-ins, then a conflict exists between the third-party plug-ins and the IDE plug-ins.

## Display deprecated items

Select this option to have the Code Completion window display obsolete programming-language items. Clear the option to have the window hide the obsolete items.

Deprecated items appear in gray text in the Code Completion window.



## Do nothing to project windows

Select this option to prevent the IDE from manipulating project windows when starting a debugging session. Use this option to help debug multiple build targets or multiple projects.

## Documents

In this field enter the number of recent documents to display in the **Open Recent** submenu.

## Do not step into runtime support code

Select this option to have the IDE bypass stepping into the Main Standard Library (MSL) runtime support code and instead directly step into your own code. Clear the option to have the IDE step into the MSL runtime setup code, then step into your own code.

## Drag and drop editing

Select this option to allow dragging and dropping of text in editor windows. Clear the option to disable drag-and-drop text editing.

## Dump internal browse information after compile

Select this option to view the raw browser information that a plug-in compiler or linker provides for the IDE. Use this option to help develop plug-ins for use with the IDE.

---

**NOTE** After enabling the **Dump internal browse information after compile** option, compile only single files or small files. Compiling an entire project can create huge internal browser information for the IDE to display.

---

---

## E

### Edit Commands

Select this option to add **Edit** menu commands to IDE contextual menus. Clear the option to remove the commands from the contextual menus.

### Edit Language

Choose from this pop-up menu the programming language to associate with the selected file mapping. The selected language determines the syntax-color scheme. For example, choose *C/C++* to apply the appropriate syntax-color scheme for C or C++ programming-language components.

### Enable automatic Toolbar help

Select this option to display Balloon Help after resting the cursor over a toolbar button. Clear the option to prevent Balloon Help from appearing.

### Enable remote debugging

Select this option to define a remote-debugging connection specific to the current build target. Choose from the **Connection** pop-up menu the general connection to use as the basis for the target-specific connection.

### Enable Virtual Space

Use this option to configure the editor for handling spaces in different ways.

- selected—the editor allows moving the text-insertion point past the end of a line of text, using either the arrow keys or the mouse. After moving to the desired position, begin entering text. The editor automatically inserts spaces between the former end of the line and the newly entered text.
- cleared—the editor requires manual insertion of spaces to move past the end of a line of text.

### Environment Settings

Use this section to specify environment variables to pass to your program as part of the environment parameter in your program's `main()` function, or as part of environment calls. These environment variables are only available to the target program. When your program terminates, the settings are no longer available.

---

**NOTE** The **Environment Settings** section appears only when you develop code for a Windows build target. The section does not appear for any other build target.

---

### Export Panel

Click this button to save to an Extensible Markup Language (XML) file the current state of the active preference or settings panel.

### Extension

In this field enter a filename extension, such as the `.c` or `.h`, for a selected File Type in the File Mappings list. [Table 29.2](#) lists default filename extensions.

**Table 29.2 Default Filename Extensions**

Type	Extension	Explanation
Minimum CodeWarrior Installation	<code>.iSYM</code>	CodeWarrior Intel® Symbols
	<code>.mch</code>	CodeWarrior Precompiled Header
	<code>.mcp</code>	CodeWarrior Project File
	<code>.dbg</code>	CodeWarrior Debug Preferences
	<code>.exp</code>	Exported Symbol File
	<code>.iMAP</code>	CodeWarrior Link Map
	<code>.MAP</code>	CodeWarrior Link Map
Assembly	<code>.a</code>	Assembly Source File (Windows)
	<code>.asm</code>	Assembly Source File
	<code>.dump</code>	CodeWarrior Disassembled File
C and C++	<code>.c++</code>	C++ Source File
	<code>.cc</code>	C++ Source File
	<code>.hh</code>	C++ Header File
	<code>.hpp</code>	C++ Header File
	<code>.i</code>	C Inline Source File
	<code>.icc</code>	C++ Inline Source File
	<code>.m</code>	Object C Source File
	<code>.mm</code>	Object C++ Source File

## Preference and Target Settings Options

**Table 29.2 Default Filename Extensions (*continued*)**

Type	Extension	Explanation
Default C and C++	.c	C Source File
	.cp	C++ Source File
	.cpp	C++ Source File
	.h	C and C++ Header File
Default Java	.class	Java Class File
	.jar	Java Archive File
	.jav	Java Source File
	.java	Java Source File
Java	.JMAP	Java Import Mapping Dump
	.jprob	Java Constructor File
	.mf	Java Manifest File
Library	.a	(Static) Archive Library (Solaris and Linux)
	.lib	Library File
	.o	Object File (Windows)
	.o	Object (Relocatable) Library or Kernel Module (Solaris and Linux)
	.obj	Object File
	.pch	Precompiled Header Source File
	.pch++	Precompiled Header Source File
	.so	Shared Library (Linux)
Script	.sh	Shell Script (Linux)
	.psh	Precompile Shell Script (Linux)
	.pl	Perl Script (Linux)

## F

## Factory Settings

Click this button to change all modified options to their default values in the current preference or settings panel.

## Failure

Choose from this pop-up menu a sound to play after a **Bring Up To Date** or **Make** operation fails.

## File Type

Enter in this field the four-character file type for the selected file mapping in the **File Mappings** list.

## Find and compare operations



A bullet in the **Find and compare operations** column, whose label appears at left, indicates that the IDE ignores matching folders for find-and-compare operations. Such operations include dragging a folder into fields in the **Find** window, or comparing folder contents.

## Find Reference using

Choose from the **Find Reference using** options, an online browser application to look up references and definitions.

For example, use this option to look up documentation for language keywords:

1. Select an online browser application, such as THINK Reference, with the **Find Reference using** option.
2. Select a language keyword, such as `boolean`, in the source code.
3. Choose the **Find Reference** menu command. The IDE looks up reference information for the `boolean` keyword in the THINK Reference documentation.

Although they are not included with the CodeWarrior product, the IDE supports these online browser formats:

- PalmQuest Reference (Palm Pilot)
- QuickView

## Preference and Target Settings Options

---

- THINK Reference

### Font

Choose from the **Font** options the typeface to use for displaying text in editor windows. This setting behaves in two different ways, depending on the current IDE state:

- No editor windows open—the setting modifies the default font. All editor windows take on the default font.
- Editor windows open—the setting modifies the font displayed in the frontmost editor window only. Other editor windows remain unaffected. The default font remains unchanged.

### Font preferences

Select the **Font preferences** option to remember font settings for each file in a project. Clear the option to use the default font settings every time the IDE opens each file. The **Font & Tabs** preference panel defines the default settings.

### Foreground

Use the **Foreground** option to configure the color of any text not affected by the **Activate Syntax Coloring** or **Activate Browser Coloring** options.

Click the color swatch to change the current color.

### Frames

Use the **frames** text box to enter the number of stack frames to display in the Thread window. Check the [Limit Stack Crawls](#) checkbox to enable the frames text box and edit the value in it.

---

## G-I

### Generate Browser Data From

Choose from this pop-up menu whether the IDE generates browser data, and from what source it generates that data.

Choose from these possibilities:

- **None**—Disable browser-data generation. Certain IDE features that use browser data will be unable to work with the project, but the project's size will be smaller.

- **Compiler**—Have the IDE use the compiler to generate browser data. If you choose this option, you must Make the project in order to generate the browser data. The IDE uses the compiler assigned to the project to generate browser data during the build process.
- **Language Parser**—Have the IDE use the language parser to generate the browser data. Certain IDE features, such as C/C++ Code Completion, function more effectively if you choose this option. The IDE uses the language parser assigned to the project to generate browser data.

---

**NOTE** If you choose the **Language Parser** option, you can also have the IDE take into account your custom macro definitions. To do so, enter the path to your prefix file in the **Prefix file** field and the path to your macro file in the **Macro file** field.

---

## Grid Size X

In the **Grid Size X** field enter the number of pixels to space between markings on the x-axis of the Layout Editor grid.

## Grid Size Y

In the **Grid Size Y** field enter the number of pixels to space between markings on the y-axis of the Layout Editor grid.

## Hide non-debugging windows

Select the **Hide non-debugging windows** option to hide, but not close, non-debugging windows when starting a debugging session.

To reveal the hidden windows, do one of these tasks:

- Use the **Window** menu, or
- Double-click the names of the hidden files in the Project window, or
- Perform lookups for symbols within the hidden windows.

At the end of the debugging session, the IDE automatically reveals the hidden windows.

## Host Application for Libraries & Code Resources

The **Host Application for Libraries & Code Resources** field lets you specify a host application to use when debugging a non-executable file, such as a shared library, dynamic link library (DLL), or code resource. The application that you specify in this field

## Preference and Target Settings Options

---

is not the debugger application, but rather the application with which the non-executable file interacts.

### Host Flags

The **Host Flags** list pop-up defines the host platforms which can use the selected access path. The settings include:

- **None**—no host can use this access path.
- **All**—all hosts can use this access path.
- **Windows**—only use this path for Windows build targets.

---

**NOTE** Multiple hosts can be selected.

---

### Import Panel

Click **Import Panel** to load the contents of a previously saved Extensible Markup Language (XML) file into the active preference or settings panel.

### Initial directory

In this field enter the initial directory for use with the external debugger. Alternatively, click **Browse** to open a dialog box. Use the dialog box to select the initial directory.

### Interpret DOS and Unix Paths

This option determines how the IDE treats filenames for interface files:

- **Selected**—the IDE treats the backslash (\) and the forward slash (/) characters as subfolder separator characters. In the example

```
#include "sys/socks.h"
```

the IDE searches for a subfolder called `sys` that contains a `socks.h` file.
- **Cleared**—the IDE treats both the backslash and forward slash characters as part of the filename. Using the same example, the IDE now searches for a `sys/socks.h` filename.



## K-L

### Keywords

Use the **Keywords** option to configure the color of C, C++, and Java programming language's keywords displayed in editor windows when the **Activate Syntax Coloring** option is enabled. Coloring does not include macros, types, variables defined by system interface files, or variables defined in source code. Click the color swatch next to Keywords to set the color.

### Launch Editor

Enter in the **Launch Editor** field a command-line expression that specifies the third-party text editor that the CodeWarrior IDE runs to edit text files.

The IDE expands the `%file` variable of the command-line expression into the full file path. For example, to run the Emacs text editor to edit text files, enter this command-line expression:

```
runemacs %file
```

Consult the documentation provided with the third-party text editor for more information about using command lines.

### Launch Editor w/ Line #

Enter in the **Launch Editor w/ Line #** field a command-line expression that specifies the third-party text editor that the IDE runs to edit text files, and an initial line of text that the third-party editor displays upon running.

The IDE expands the `%line` variable of the command-line expression into an initial line of text for the third-party text editor to display. For example, to run the Emacs text editor to edit a text file, and to have the Emacs editor display the line provided to it by the IDE, enter this command-line expression:

```
emacs %file %line
```

Consult the documentation provided with the third-party text editor for more information about using command lines.

### Launch remote host application

Select this option to launch an application on the remote computer to serve as a host application. Enter the path to the remote host application.

### Left margin click selects line



Select the **Left margin click selects line** option to use a right-pointing cursor, shown at left, to select entire lines of text from the left margin. Clear the option to disable use of the right-pointing cursor.

With the right-pointing cursor active, click in the left margin to select the current line, or click and drag along the left margin to select multiple lines.

### Level

Choose from the **Level** options the amount of information reported for IDE plug-ins in development. This information is useful for diagnosing plug-in behavior or for viewing information about the properties of installed plug-ins.

Choose one of these levels of plug-in diagnostic information:

- **None** (default)—The IDE does not activate plug-in diagnostics or produce output.
- **Errors Only**—The IDE reports problems encountered while loading plug-ins. These problems appear in a new text file after the IDE starts up
- **All Info**—The IDE reports information for each installed plug-in, such as problems with plug-in loading, optional plug-in information, and plug-in properties. This information appears in a new text file after the IDE starts up. The text file also contains a complete list of installed plug-ins and their associated preference panels, compilers, and linkers.

The IDE allows saving and printing the text file. Use the file as an error reference for troubleshooting plug-ins. The text file also provides suggestions for correcting general plug-in errors.

### Linker

Use the **Linker** option menu to select the linker to use with the project. The choices available are always dependent on the plug-in linkers that are available to the CodeWarrior IDE.

To learn more about the linkers, see the appropriate *Targeting* manual.

### Limit Stack Crawls

Check the **Limit Stack Crawl** checkbox to limit the number of stack frames to display in the Thread window. You can enter the desired number of frames in the [Frames](#) text box.

---

## Location of Relocated Libraries and Code Resources

Enter in this field the path to the relocated libraries and code-resource files required for debugging the project. Alternatively, click **Choose** to display a dialog box. Use the dialog box to select the required files.

## Log System Messages

Select this option to have the IDE maintain a log of all system messages generated during the debugging session. The Log window displays this platform-specific information. Clear the option to disable the log.

---

## M

### Make new access paths recursive

Selecting this option will create all new access paths as recursive. The default is off.

### Menu bar layout

Choose from the **Menu bar layout** options the desired configuration of menus listed in the IDE:

- **Windows**—organizes the menu bar according to a typical Microsoft® Windows® arrangement

### Minimize non-debugging windows

Select the **Minimize non-debugging windows** option to minimize non-debugging windows to a reduced size when a debugging session starts. At the end of the debugging session, the IDE automatically restores the minimized windows.

---

**NOTE** The **Minimize non-debugging windows** option is only available in MDI mode.

---

See also:

- [Use Multiple Document Interface](#)

## Preference and Target Settings Options

---

---

### O

#### Output Directory

Use the **Output Directory** caption to show the location the IDE places a final linked output file. The default location is the directory that contains your project file. Select **Choose** to specify the location path.

#### On IDE Start: Do Nothing

Select the **Do Nothing** option to have the IDE do nothing when it starts.

#### Open Empty Text Document

Select the **Open Empty Text Document** option to open an empty text document when IDE starts.

---

### P

#### Play sound after ‘Bring Up To Date’ & ‘Make’

Select the **Play sound after ‘Bring Up To Date’ & ‘Make’** option to play a sound after a build operation completes. Choose different sounds for successful and unsuccessful builds using the **Success** and **Failure** pop-up options, respectively.

See also:

- [Failure](#)
- [Success](#)

#### Plugin Startup Actions

Use this field to configure plug-ins that perform startup actions. The **Plugin Startup Actions** field contains a list of the startup plug-ins included with the product. You can check or clear the checkboxes next to a plug-in to use it to perform startup actions, such as displaying a Startup dialog box, when IDE starts.

---

## Post-linker

Use the **Post-linker** option to select a post-linker that performs additional work (such as format conversion) on the final executable file.

For more information see the appropriate *Targeting* manual.

## Pre-linker

Use the **Pre-linker** option to select a pre-linker that performs additional work on the object code in a project. This work takes place before the IDE links the object code into the final executable file.

For more information about the pre-linkers available, see the build targets *Targeting* manual.

## Program Arguments

Use the **Program Arguments** field to enter command-line arguments to pass to the project at the beginning of a debugging session. Your program receives these arguments after you choose **Project > Run**.

## Program entry point

Select this option to halt program execution upon entering the program.

## Projects

Enter the number of recent projects to display in the **Open Recent** submenu.

## Project Commands

Select the **Project Commands** option to add **Project** menu commands to contextual menus. Clear the option to remove the commands from the contextual menus.

## Project operations



A bullet in the **Project operations** column, whose label appears at left, indicates that the IDE ignores matching folders for project operations. Such operations include dragging a folder into the Project window, building a project, or searching access paths after choosing **File > Open**.

## Preference and Target Settings Options

---

### Purge after

Enter the number of days after which the IDE deletes its file cache.

### Purge Now

Click **Purge Now** to delete the contents of the current file cache.

---

## R

### Recommended

Select the **Recommended** option to allow the number of concurrent compiles suggested by the IDE. This suggestion takes into account the number of active Central Processing Units (CPUs) on the host computer.

### Re-execute target init script even if already connected

Use this list box to specify whether to re-execute the target init script at the start of every debug session, even if the connection remains alive.

A target init script is a set of command-line window commands that initialize a board with the particular settings at the board bring-up.

### Regular Expression

Enter in the **Regular Expression** field a text pattern to match against folder names. The IDE excludes matching folders and their contents from selected project operations or find-and-compare operations.

### Relaxed C popup parsing

Use the **Relaxed C popup parsing** option to control the strictness of C coding conventions:

- Select the option to have the IDE recognize some non-standard functions that interfere with Kernighan-and-Ritchie conventions. The IDE displays the non-standard functions in the **Routine** list pop-up.

- 
- Clear the option to have the IDE recognize only functions that conform to Kernighan-and-Ritchie conventions. The IDE displays only the standard functions in the **Routine** list pop-up.

For more information, refer to “Reference Manual,” of *The C Programming Language, Second Edition*, by Kernighan and Ritchie, published by Prentice Hall.

---

**NOTE** Toggle the **Relaxed C popup parsing** option to maximize recognition of functions, macros, and routine names in the source code.

---

## Reload externally modified files automatically

Selecting this option will reload files modified outside the CodeWarrior editor automatically with no alert dialog. The default off.

## Remote download path

Enter the path to the directory in which to store files downloaded from the remote host application.

## Reopen I/O console as needed

Check the **Reopen I/O console as needed** checkbox to have the IDE reopen the I/O console window, when the application writes to the console. When the window reopens, the contents of the console window before closing are not restored to the reopened console.

If you clear this checkbox, the closure of the console window during a debug session is permanent and the console window does not reopen.

## Require Framework Style Includes

This option determines the strictness with which the IDE treats `#include` statements for frameworks:

- selected—the IDE requires the framework in addition to the referenced header file. In the example  

```
#include <Cocoa/CocoaHeaders.h>
```

the IDE requires the presence of `Cocoa/` in order to find the `CocoaHeaders.h` file.
- cleared—the IDE requires only the referenced header file. Using the same example, `Cocoa/` becomes optional.

## Restore Default Workspace

Select this option to have the IDE use the default workspace. The IDE uses the default workspace to save and restore window and debugging states from one session to the next.

For example, if you select this option and close the IDE with a project window visible onscreen, that project window reappears the next time you start the IDE.

## Revert Panel

Click **Revert Panel** to revert all modified options in the current preference or settings panel to the values present when the panel was originally opened.

---

## S

### Save open files before build

Select the **Save open files before build** option to automatically save files during project operations:

- Preprocess
- Precompile
- Compile
- Disassemble
- Bring Up To Date
- Make
- Run

### Save project entries using relative paths

Use the **Save project entries using relative paths** option to store the location of a file using a relative path from one of the access paths. The settings include:

- **enabled**—the IDE stores extra location information to distinctly identify different source files with the same name. The IDE remembers the location information even if it needs to re-search for files in the access paths.
- **disabled**—the IDE remembers project entries only by name. This setting can cause unexpected results if two or more files share the same name. In this case, re-searching for files could cause the IDE to find the project entry in a different access path.



## Script

Choose from the **Scripts** options the script system (language) used to display text in editor windows. This setting behaves in two different ways, depending on the current IDE state:

- No editor windows open—the setting modifies the default script system. All editor windows take on the default script system.
- Editor windows open—the setting modifies the script system displayed in the frontmost editor window only. Other editor windows remain unaffected. The default script system remains unchanged.

## Select thread window when stopping task

Check the **Select thread window when stopping task** checkbox to automatically bring the Thread window to the foreground after the debugger stops a task. Clear the checkbox to leave the Thread window in its previous position.

This option is useful for watching variable values change in multiple Variable windows as the debugger steps through code.

## Selection Position

Select the **Selection position** option to remember these items for each editor window:

- visible text
- insertion-point location
- selected text

Clear the option to open each editor window according to default settings and place the insertion point at the first line of text.

---

**NOTE** The IDE must be able to write to the file in order to remember selection position.

---

## Show all locals

Select the **Show all locals** option to display all local variables in Variable windows. Clear the option to show only variables near the program counter.

The Variables pane uses these display settings:

- **Variables: All**—shows all local variables in the code.
- **Variables: Auto**—only shows the local variables of the routine to which the current-statement arrow currently points.

## Preference and Target Settings Options

---

- **Variables: None**—does not show variables. Use this setting to improve stepping performance for slow remote connections.

### Show Code and Data Sizes

Enable this option in the IDE Extras panel of the IDE preferences panels to display the Code and Data columns in the project manager window.

### Show hidden locals

In previous versions of the CodeWarrior debugger, all local variables were displayed at all times in the local variables view. This meant that if there were multiple sub-scopes within a function that contained variables of the same name, all copies of these variables would be shown at all times. This made it difficult at times to determine which copy of a variable was the “current” one.

The CodeWarrior debugger now optionally filters out out-of-scope local variables in the local variables view. It is now possible to make the CodeWarrior debugger only display those variables that are actually “live” for the current location.

A new filter option (live) has been added to the existing options (all, auto, and none). The new option will attempt to filter out variables that are not currently in scope.

A hidden local variable is a variable that is in scope, but is hidden by a variable of the same name in a deeper scope. If the Show hidden locals option is checked, hidden locals are shown dimmed (greyed out).

Consider the [Listing 29.1](#) function:

#### Listing 29.1 Hidden Locals Example

---

```
int main( void )
{
    char varA = 'a';
    int varB = 111;

    for (int loop1 = 0; loop1 < 10; loop1++)
    {
        /* loop-scoped variables that should hide all others */
        char varA = 'b';
        float varB = 2.22;
        .
        .
        .
    }
    .
    .
    .
```

---

```
}
```

---

When debugging this function, the earlier CodeWarrior debugger would show five variables at all times:

```
loop1 : int
varA : char
varA : char
varB : int
varB : float
```

This could be confusing, since the different varA's were not apparent in the local variables pane. With the new "live" filter, only those variables that are actually active at a given point in the function are displayed. Using the "live" filter, this display will look like this at the beginning of the function:

```
varA : char
varB : int
```

and the display will look like this when inside the for loop:

```
loop1 : int
varA : char
varB : float
```

Note in the second case that the varA and varB variables declared at the beginning of the function are still "live", but they are hidden by the same-named variables declared within the for loop. If you would like these hidden variables to be displayed, check the "Show hidden locals" option; the variable list when inside the for loop looks like this:

```
loop1 : int
varA : char // displayed as dimmed
varA : char
varB : int // displayed as dimmed
varB : float
```

---

**NOTE** This feature ONLY works correctly if there is compiler and symbolics plug-in support for sub-scopes within functions. At present, there are very few compilers that actually generate sub function-level scope information, so it is entirely possible that you will see no difference between the "live" and "all" settings -- you will continue to have the "classic" CodeWarrior variable display with all variables shown.

---

## Show message after building up-to-date project

Select the **Show message after building up-to-date project** option to have the IDE display a message after building an up-to-date project.

## Show threads in separate windows

Select the **Show threads in separate windows** option to open a separate Thread window for each task. Clear the option to use one Thread window to display multiple tasks.

## Show processes in separate windows

Select the **Show processes in separate windows** option to open a separate window for each process. Clear the option to use one window to display multiple tasks processes.

## Show the component palette when opening a form

Select the **Show the component palette when opening a form** option to automatically display the Component Palette after opening a form in the Layout Editor. Clear the option to require manual opening of the Component Palette.

## Show the object inspector when opening a form

Select the **Show the object inspector when opening a form** option to automatically open an Object Inspector window when opening a layout in the Layout Editor. Clear the option to require manual opening of the Object Inspector.

## Show values as decimal

Select the **Show values as decimal instead of hex** option to display variable values in decimal form. Clear the option to display the values in hexadecimal form.

## Show variable location

Select the **Show variable location** option to display the **Location** column in the Variables pane of the Thread window. Clear the option to hide the **Location** column.

## Show variable types

Select the **Show variable types** option to display the type associated with each variable in Variable windows. Clear the option to hide the variable types.

## Show variable values in source code

Select the **Show variable values in source code** option to show current values for variable names displayed in contextual menus. Clear the option to show variable names only.

## Size

Choose from the **Size** options the font size used to display text in editor windows. This setting behaves in two different ways, depending on the current IDE state:

- No editor windows open—the setting modifies the default font size. All editor windows take on the default font size.
- Editor windows open—the setting modifies the font size displayed in the frontmost editor window only. Other editor windows remain unaffected. The default font size remains unchanged.

## Sort functions by method name in symbolics window

Select the **Sort functions by method name in symbolics window** option to alphabetically sort functions by method name. Clear the option to alphabetically sort by class name. The sorting affects functions of the form `className:methodName` that appear in the Symbolics window.

Since most C++ and Java source files contain methods that belong to the same class, select the option to simplify selection of functions by typing method names.

## Stop at Watchpoints

Check the **Stop at Watchpoints** checkbox to halt program execution at a watchpoint. Clear the option to have the debugger report the watchpoint in a message window, displaying information about the watchpoint that is encountered and the location of the watchpoint in the source code.

## Stop on application launch

Select this option to halt program execution at a specified point each time a debugging session begins.

## Preference and Target Settings Options

---

### Strings

Use the **Strings** option to configure the color of anything that is not a comment, keyword, or custom keyword and displayed in editor windows when the **Activate Syntax Coloring** option is enabled. Sample strings include literal values, variable names, routine names, and type names.

Click the color swatch next to Strings to set the color.

### Smart Variable Formatting

The Variable Formatter is an IDE plug-in that customizes the display of Variables based on format data it reads from an XML format file. For specific types of variables, the Variable Formatter will replace the text shown next to the variable name to the results of an expression. For example, if you have a struct:

---

```
struct Rect {
    short          top;
    short          left;
    short          bottom;
    short          right;
};
```

---

then normally a variable of that type would look like this in the debugger:

```
myRect 0x000DCEA8
```

If the Variable Formatter is given a format that looks like this:

---

```
<variableformat>
<typename>Rect</typename>
<expression>
"{T: " + ^var.top +
" L: " + ^var.left +
" B: " + ^var.bottom +
" R: " + ^var.right +
"}{H: " + (^var.bottom - ^var.top) +
" W: " + (^var.right - ^var.left) + "}"
</expression>
</variableformat>
```

---

then the variable will be displayed with the result of the expression:

```
myRect {T: 30 L: 30 B: 120 R: 120}{H: 90 W: 90}
```

When the IDE starts, the variable formatter plug-in looks in the plug-in's support folder for a "Variable Formats" folder. It scans this folder for XML files and reads the variable formats for each one.

Variable Format Tags:

*variableformat* - Identifies the start of a variable format record.

*osName* - Restricts format use to the indicated operating system. OS names is “osWin32”.

*runtimeName* - Restricts format use to the indicated runtime model. Runtime names are “runtimePPCCFM”, “runtimePPCMacho” and “runtimeWin32”.

*cpuName* - Restricts format use to the indicated CPU model. CPU names are “cpuPowerPCBig”, “cpuJava” and “cpux86”.

*typeName* - Identifies the name of the Type this record will format.

*condition* - Specifies a condition that must be met for the format to be used. This can be used to test for one element of data before attempting to format another element.

*typenamematch* - Specifies how to match type names to variable types. Possible values are: “ExactMatch”, “BeginsWith”, “EndsWith”, and “Contains”.

*expression* - Specifies an expression string. The expression will be evaluated and the result displayed next to the variable. Before evaluation, all instances of “^var” in the format string will be replaced with the name of the variable.

*expressionformat* - Specifies the data format to use when formatting an expression. The format names match the menu item names in the “Data” menu: “Pascal String”, “C String”, “Character”, “Unicode” etc.

## Sort function popup

Select the **Sort function popup** option to sort function names by alphabetical order in list pop-ups. Clear the option to sort function names by order of appearance in the source file.

## Source relative includes

Select to search for dependent files in the same location as the source file. If the dependent file is not found in this location, specified User and System paths are searched. If this option is enabled, the Always Search User Paths should also be enabled. For example, if the compiler is currently scanning the main source file and discovers an include header file statement, the header file is searched for in the same location as the main file. If not found, the specified access paths will be searched. If the header file declared in the main file also contains an include statement for another header file, it too will be searched for in the same sequence.

If this option is disabled the specified User and System paths are searched.

## Success

Choose from the **Success** options a sound to play after a **Bring Up To Date** or **Make** operation succeeds.

### Symbolics

Enter the number of recent symbolics files to display in the **Open Recent** submenu.

### System Paths

Click the **System Paths** radio button to display the System Paths pane in the Access Paths preference panel.

Supported hosts:

- Windows: available.

---

## T

### Tab indents selection

Use the **Tab indents selection** option to control how the editor inserts tabs into the currently selected lines of text:

- Select the option so that pressing Tab causes the editor to insert tab characters in front of each selected line of text. The editor thereby indents the selected text.
- Clear the option so that pressing Tab causes the editor to replace selected text with a tab character. The editor thereby overwrites the selected text.

### Tab Inserts Spaces

Select the **Tab Inserts Spaces** option to have the editor insert spaces instead of tab characters into text. Clear the option to have the editor use tab characters.

The **Tab Size** option determines the number of spaces inserted by the editor.

### Tab Size

Enter in the **Tab Size** field the number of spaces to substitute in place of a tab character in text. This number applies to the **Tab Inserts Spaces** option.

### Target Name

Use the **Target Name** text box to set or modify the name of the current build target. This name appears in the Targets view in the Project window. This name is not the name assigned to the final output file, that is set in the Linker panel for the build target.



## Type

Choose from the **Type** options the desired source-tree path type:

- **Absolute Path**—This source-tree type is based on a file path.
  - **Environment Variable**—This source-tree type is based on an existing environment-variable definition.
  - **Registry Key**—This source-tree type is based on an existing Windows registry key entry.
- 

## U

### Update data every $n$ seconds

Select this option to update the information displayed in debugging-session windows after a specified time interval. Enter the number of seconds  $n$  to elapse before the next update. Clear this option to prevent data updates and keep the same window information throughout the debugging session.

### Use Concurrent Compiles

Select the **Use Concurrent Compiles** option to run more than one compiling process at a time. Concurrent compiling makes better use of available processor capacity by allowing the operating system to optimize resource utilization, such as taking advantage of overlapped input/output.

Both single- and multi-processor systems benefit from enabling concurrent compiles. On multiprocessor systems, the speed-up is significant.

### Use External Debugger

Select this option to have the IDE use an external debugger application in place of the CodeWarrior debugger.

### Use External Editor

Select the **Use External Editor** option to use an external text editor to modify text files in the current project. Clear the option to use the text editor included with the IDE.

There are situations in which the user may want to use the internal editor while the **Use External Editor** option is selected. The following are a few ways in which to do so.

## Preference and Target Settings Options

---

- Use the "Toggle external editor mode" icon. This is the icon at the rightmost position on the main IDE tool bar. (in default configuration) When this icon is selected a file is opened by the external editor.

When this icon is not selected a file is opened by the internal editor.

The default Key Binding for this function is "Ctrl + J".

- Use "Alt" key

If you double-click the mouse button while pressing the "Alt" key or press "Alt + Enter" on a file name in the project window, the file is opened with the internal editor.

- To open the source location of a definition or declaration with the internal editor from the opened source file in the internal editor.

1) Right-click on the variable / type declaration / function / macro / class.

2) Left-click with "Ctrl" or press "Ctrl + Enter" on the "Go to xxxx definition of xxxx" or "Go to xxxx declaration of xxxx" on the pop-up menu.

## Use Local Project Data Storage

Select the **Use Local Project Data Storage** option to store (on the host computer) data associated with a project file on a read-only volume. Clear the option to store project data inside the same folder as the project file itself.

After loading a project file, the IDE creates or updates an associated project data folder. The IDE stores intermediate project data in this folder. When building or closing a project, the IDE uses the information in the project data folder to update the project file.

By default, the IDE places the project data folder within the same folder as the project file. However, the IDE cannot create or update a project data folder in a location that grants read-only privileges.

If you are creating one project to be accessed by multiple users that are running CodeWarrior on separate machines, then each user should select this option to create a local data storage folder for the shared project. The folder containing the project file should be set to read-only. This will cause the target information to be stored locally on each user's machine, instead of inside a folder next to the project file.

## Use modification date caching

Use the **Use modification date caching** option to determine whether the IDE checks the modification date of each project file prior to making the project. The settings include:

- **enabled**—the IDE caches the modification dates of the files in a project. At compilation time, the IDE refers to this cache to determine whether a specific file should be recompiled. This can shorten compilation time significantly for large projects.

- 
- **disabled**—the IDE checks every file at each recompile of the project. Use this setting if using third-party editors to ensure that the IDE checks every file at compilation time.

## Use Multiple Document Interface

Toggle this option to change the IDE interface:

- **Selected**—The IDE uses **MDI** (Multiple Document Interface). In this interface, the IDE uses a main application window with a gray background. IDE windows appear inside the main application window. The gray background obscures your view of the desktop.
- **Cleared**—The IDE uses **FDI** (Floating Document Interface). In this interface, the IDE does not use a main application window. You can see through the IDE user interface to your desktop. IDE windows appear above the desktop.

## Use multiple undo

Select the **Use multiple undo** option to remember several undo and redo operations in editor windows. Clear the option to remember only the most recent undo or redo action.

The IDE stores undo and redo actions on a stack in first-in last-out (FILO) order, however, the stack size and capability are limited. For example, assume there are five undo actions on the stack (ABCDE). If the IDE redoes two actions (ABC), then performs a new action (ABCF), the undo events (DE) are no longer available.

## Use “not found” Dialog

Check the **Use “not found” dialog** checkbox to have the IDE display a “not found” message if search for an item in any window, such as Editor, Errors and Warnings, and Class Browser, fails.

If you clear the checkbox and search for an item in any of the windows fails, IDE does not display any message informing you about the search failure.

## Use Script menu

Select the **Use Script menu** option to display the **Scripts** menu in the IDE menu bar. Clear the option to remove the Scripts menu from the menu bar. The Scripts menu provides convenient access to IDE scripts.

For more information about scripting the IDE, refer to the *CodeWarrior Scripting Reference*.

## Use Text-Based Projects

Check the **Use text-based projects** checkbox to have IDE use the xml (text) based files for projects instead of the binary mcp files. When this option is selected, the IDE converts a binary project to text-based project, the first time project opens. XML text-based projects can also have .mcp extensions, in addition to .mcp.

With Text-based projects, you can change settings in a project easily by editing the XML file instead of using IDE. Whereas, in binary projects you need to load the project in IDE to manipulate the project settings.

Text-based projects also let you keep track of the versions of the mcp files using diff or xmldiff, if the files are stored in a version control system, such as CVS.

To convert a text-based project to a binary project:

1. Make sure that the **Use text-based projects** checkbox in the **IDE Extras** preference panel is cleared.
2. Select **File > Import Project**. The **Open** dialog box appears.
3. Select a text-based project to convert to binary and click **Open**. The **Name new project as** dialog box appears.
4. Enter a name for the binary project in the **File name** field and click **Save**.

The Project window displays the converted project.

## Use Third Party Editor

Select the **Use Third Party Editor** option to use a third-party text editor to modify text files. Clear the option to use the text editor included with the IDE.

Enter in the **Launch Editor** and **Launch Editor w/ Line #** fields command-line expressions that specify information that the IDE passes to the third-party editor.

Consult the documentation provided with the third-party text editor for more information about using command lines.

See also:

- [Launch Editor](#)
- [Launch Editor w/Line #](#)

## Use ToolServer menu

Select the **Use ToolServer menu** option to display the **ToolServer** menu in the IDE menu bar. Clear the option to remove the ToolServer menu from the menu bar.

## User Paths

Click this radio button to display the **User Paths** pane in the **Access Paths** preference panel.

## User Specified

Select the **User Specified** option to stipulate the number of concurrent compiles to allow in the IDE. Enter the desired number in the text box beside the option.

---

**NOTE** The IDE accommodates a maximum of 1024 concurrent compiles. However, there is a point where the host system becomes compute-bound, and allowing more processes only adds overhead. For a single-processor system, the practical limit is approximately 12 concurrent compiles.

---

---

## V

### Value

The **Value** text box defines the value of the variable defined in the **Variable** text box that will be passed to a host application when control is transferred to it by the IDE.

### Variable

The **Variable** text box defines the name of a variable to be passed to a host application when control is transferred to it by the IDE.

### Variable values change

Use the **Variable values change** option to configure the color of changed variables that appear in debugger windows. Click the color swatch to change the current color.

### VCS Commands

Select the **VCS Commands** option to add **VCS** menu commands to contextual menus. Clear the option to remove the commands from the contextual menus.

Refer to the documentation that came with the version control system to learn about using it with the CodeWarrior IDE.

### W-Z

#### Watchpoint indicator

Use the **Watchpoint indicator** option to configure the color of watchpoints that appear in debugger windows. Click the color swatch to change the current color.

#### When Debugging Starts: Do nothing

Select this option to leave all windows in place during a debugging session.

#### Window follows insertion point

Select this option to have the Code Completion window follow the insertion point as you edit text in the active editor window. Clear the option to leave the Code Completion window in place.

#### Window position and size

Select the **Window position and size** option to remember the location and dimensions of each editor window. Clear the option to open each editor window according to default settings.

---

**NOTE** The IDE must be able to write to the file in order to remember window position and size.

---

#### Working Directory

Enter the path to the default directory to which the current project has access. Debugging occurs in this location. If this field is blank, debugging occurs in the same directory as the executable file.

#### Workspaces

Enter the number of recent workspace files to display in the **Open Recent** submenu.

## Zoom windows to full screen

Use the **Zoom windows to full screen** option to configure the behavior of the zoom box in the upper right-hand corner of all editor windows:

- Select the option to have the IDE resize a zoomed window to fill the entire screen.
- Clear the option to have the IDE resize a zoomed window to its default size.



## Preference and Target Settings Options

---



# Register Details Window XML Specification

---

The CodeWarrior Register Details window provides online documentation about hardware registers up to 32 bits in length. This chapter helps describes the register and its constituent parts. Furthermore, the Register Details window can dynamically update its information to reflect changes in register state or changes in bitfield values.

The Register Details window documentation can include bitfield descriptions, descriptions that change based on certain conditions, and explanations of bitfield values. The same window handles both system registers and memory-mapped registers.

CodeWarrior parses XML files with specific tags to display the appropriate information in the window. This chapter describes the XML format understood by the Register Details window:

- [Register Details Window XML Specification](#)
- [Accessing the XML Files from CodeWarrior](#)
- [A Sample XML File](#)
- [References](#)

## Register Details Window XML Specification

XML consists of elements, which are similar to tags in Hypertext Markup Language (HTML). Each element contains attributes that give detailed information about the element structure. Some elements are required and some are optional.

As is the case with HTML, XML elements include tags that mark the beginning and end of the element, such as `<ELEM>` and `</ELEM>`. An alternate construct allows `<ELEM>` and `</>` to mark the beginning and end of the element, respectively.

Attributes can include numeric values, which you may enter in a variety of formats ([Table 30.1](#)). The table shows sample values for each format. The table also describes additional requirements for valid values that the Register Details window can understand. For example, valid character values must be enclosed in single-quote marks, like this: 'c'

## Register Details Window XML Specification

### Register Details Window XML Specification

**Table 30.1 Numeric Attribute Value Formats**

Value Format	Sample Values	Requirements
Decimal	123 and -334	
Hexadecimal	0x12 and 0X12	Preceded by 0x or 0X
Octal	012	Preceded by 0
Binary	0b11001 and 0B11	Preceded by 0b or 0B
Character	'c' and 'XYZ'	Enclosed in ''

Every XML file created for use with the Register Details window must conform to the specification shown in [Listing 30.1](#). The specification defines the following types of elements:

- [REGISTER](#)
- [BITFIELD](#)
- [BFVALUE](#)

Descriptions of these elements follow the specification.

**Listing 30.1 Register Details Window XML Specification**

```
<!DOCTYPE REGISTER [
  <!ELEMENT REGISTER      (BITFIELD+)>
  <!ATTLIST REGISTER
    NAME          CDATA      #REQUIRED
    BITRANGE      CDATA      #REQUIRED
    RESETVALUE    CDATA      #IMPLIED
    ADDRESS       CDATA      #IMPLIED
    DESCRIPTION    CDATA      #IMPLIED>

  <!ELEMENT BITFIELD      (BFVALUE*)>
  <!ATTLIST BITFIELD
    NAME          CDATA      #REQUIRED
    BITRANGE      CDATA      #REQUIRED
    FORMAT        (binary|b|hex|h|decimal|d|unsigned|u|character|c
                  |value|v) "binary"
    ACCESS        (read|r|write|w|readwrite|rw|reserved) "readwrite"
    CONDITION     CDATA      #IMPLIED
    DESCRIPTION    CDATA      #IMPLIED>

  <!ELEMENT BFVALUE      EMPTY>
  <!ATTLIST BFVALUE
```

VALUE	CDATA	#REQUIRED
DESCRIPTION	CDATA	#REQUIRED

] >

## REGISTER

The REGISTER element describes the name, bitrange, reset value, address, and general description of the register. The italicized portions of the format are placeholders that indicate where you must supply additional information. The remainder of this section describes each REGISTER attribute.

### Element Format

```
<REGISTER
  NAME           =   "RegisterName"
  BITRANGE      =   "MSB:LSB|BitNumber"
  RESETVALUE    =   "0x11223344"
  ADDRESS       =   "0x1000+4"
  DESCRIPTION   =   "RegisterDescription">
</REGISTER>
```

### Attributes

#### NAME

This attribute specifies the register name. If the element does not include an ADDRESS attribute, CodeWarrior matches XML files based on the NAME attribute, and the register is assumed to be registered with the IDE under the NAME attribute. If the element includes an ADDRESS attribute, the register is assumed to be memory mapped, and the debugger evaluates the ADDRESS attribute to find the address of the register, using the information in the NAME attribute for display purposes only.

This attribute is a required part of the REGISTER element.

You must enter a NAME attribute in the form

*String*

where *String* represents the name of the register.

#### BITRANGE

This attribute defines the register bitrange. If the bitrange is a single bit, enter the bit number. If the bitrange is longer than a single bit, enter the range separated by a colon. For example, enter 0 : 6 to specify a range from 0 to 6. The bit ordering can be in any order, such as 0 : 31 or 31 : 0. This flexibility lets you accommodate

## Register Details Window XML Specification

### Register Details Window XML Specification

---

varying product documentation, where bit ordering is sometimes reversed. However, after specifying a particular bit order, each subsequent bitrange attribute in the BITFIELD element must follow the same order.

This attribute is a required part of the REGISTER element.

You must enter a BITRANGE attribute in the form

*MSB:LSB*

or

*BitNumber*

where *MSB:LSB* refers to the range between the most-significant bit and the least-significant bit, and *BitNumber* refers to the single bit that represents the bitrange.

#### RESETVALUE

This attribute allows you to specify the register reset value.

This attribute is an optional part of the REGISTER element.

You must enter a RESETVALUE attribute in the form

*Value*

where *Value* represents the reset value of the register. Refer to [Table 30.1 on page 450](#) for more information about valid values.

#### ADDRESS

This attribute lets you specify that the register is a memory-mapped register. The CodeWarrior expression evaluator determines the value of the attribute by evaluating the following items:

- mathematical operations
- boolean operations such as AND, OR, NOT, and XOR
- the values of registers whose names begin with a dollar sign (\$)
- variables included in the generated symbolics file for the project

This attribute is an optional part of the REGISTER element.

You must enter a RESETVALUE attribute in the form

*String*

where *String* represents the name of the register.

#### DESCRIPTION

This attribute lets you provide a description for the register. This description can be of arbitrary length. The Description field in the Register Details window includes scrollbars, allowing you to view the entire description within the window.

This attribute is an optional part of the REGISTER element.

You must enter a DESCRIPTION attribute in the form

*String*

where *String* represents the description of the register.

---

## BITFIELD

The BITFIELD element describes the name, bitrange, format, access, condition, and general description of individual bitfields within the register. The italicized portions of the format are placeholders that indicate where you must supply additional information. The remainder of this section describes each BITFIELD attribute in detail.

---

**NOTE** If you choose not to describe the register bitfields, or if the register does not have bitfields that require individual descriptions, you can leave the BITFIELD element empty in the XML file.

---

### Element Format

```
<BITFIELD
  NAME           =  "BitfieldName"
  BITRANGE      =  "(MSB:LSB/Number)"
  FORMAT        =  "BitfieldFormat"
  ACCESS       =  "AccessFormat"
  CONDITION    =  "Expression"
  DESCRIPTION   =  "BitfieldDescription">
</BITFIELD>
```

### Attributes

NAME

This attribute specifies the bitfield name.

This attribute is a required part of the BITFIELD element.

You must enter a NAME attribute in the form

*String*

where *String* represents the name of the bitfield.

BITRANGE

This attribute defines the bitfield range. If the bitrange is a single bit, enter the bit number. If the bitrange is longer than a single bit, enter the range separated by a colon. For example, enter 0 : 6 to specify a range from 0 to 6. The bit ordering must

## Register Details Window XML Specification

### Register Details Window XML Specification

---

follow the order you specified in the [BITRANGE](#) attribute of the REGISTER element. See [BITRANGE](#) for more information.

This attribute is a required part of the BITFIELD element.

You must enter a BITRANGE attribute in the form

*MSB:LSB*

or

*BitNumber*

where *MSB:LSB* refers to the range between the most-significant bit and the least-significant bit, and *BitNumber* refers to the single bit that represents the bitrange.

#### FORMAT

This attribute determines the default format of the register values displayed in the Register Details window. You can enter one of the following formats for this attribute:

- binary or b
- hex or h
- decimal or d
- unsigned or u
- character or c
- value or v

If you omit this attribute, CodeWarrior assumes a default `binary` format. If you choose the `value` format, the bitfield appears as the text description `value`, or else appears in `binary` format when no description is provided for the specified bitfield value.

This attribute is an optional part of the BITFIELD element.

You must enter a FORMAT attribute in the form

*FullName*

or

*abbr*

where *FullName* represents the full name of the format and *abbr* represents the abbreviation of that format.

#### ACCESS

This attribute lets you specify the bitfield access permissions. You can enter one of the following permissions for this attribute:

- read or r
- write or w

- `readwrite` or `rw`
- `reserved` or `" "`

If you omit this attribute, CodeWarrior assumes a default `readwrite` access permission.

This attribute is an optional part of the `BITFIELD` element.

You must enter an `ACCESS` attribute in the form

*FullName*

or

*abbr*

where *FullName* represents the full name of the format and *abbr* represents the abbreviation of that format.

#### CONDITION

This attribute lets you provide a particular description for a bitfield, depending on whether a condition you specify is met. You specify a conditional *Expression* for the bitfield using the `CONDITION` attribute. CodeWarrior evaluates the expression, and if the expression is true, assumes that the bitfield attribute is valid.

This capability is useful for providing different descriptions for the same bitfield, based on the value of the *Expression*. For example, you can create two bitfield entries for the same register bit. Each bitfield entry has a distinct `CONDITION` attribute, allowing CodeWarrior to choose the appropriate `BITFIELD` element to display in the Register Details window.

This attribute is an optional part of the `BITFIELD` element.

You must enter a `CONDITION` attribute in the form

*Expression*

where *Expression* represents the condition that CodeWarrior must evaluate ([Table 30.2](#)). The expression can refer to other registers by adding a dollar sign (\$) to the beginning of each register name. The expression can also refer to the current register value by entering two dollar signs (\$\$) in the *Expression*. The Register Details window replaces these dollar signs with the current register value. The CodeWarrior expression evaluator also accepts local and global variables in the *Expression*.

## Register Details Window XML Specification

Register Details Window XML Specification

**Table 30.2 Sample Expressions for CONDITION Attribute**

Expression	Explanation
CONDITION = "\$&0x80"	The current register value ANDed with 0x80
CONDITION = "!(\$&0x80)"	The inversion of the current register value ANDed with 0x80
CONDITION = "\$MSR&0x8000"	Another register value (the MSR register) ANDed with 0x8000
CONDITION = "foo&0x10 >= 0"	An expression using a variable named foo

### DESCRIPTION

This attribute lets you provide a description for the bitfield. This description can be of arbitrary length. The Description field in the Register Details window includes scrollbars, allowing you to view the entire description within the window.

This attribute is an optional part of the BITFIELD element.

You must enter a DESCRIPTION attribute in the form

*String*

where *String* represents the bitfield description.

## BFVALUE

The BFVALUE element lets you explain the individual values of a bitfield described by the [DESCRIPTION](#) attribute in the BITFIELD element. The italicized portions of the format are placeholders that indicate where you must supply additional information. The remainder of this section describes each BFVALUE attribute.

**NOTE** If you choose not to describe individual bitfield values, or if the bitfields do not require individual descriptions, you can leave the BFVALUE element empty in the XML file.



### Element Format

```
<BFVALUE
  VALUE           = "BitfieldValue"
  DESCRIPTION     = "BitfieldValueDescription">
</BFVALUE>
```

### Attributes

#### VALUE

This attribute specifies the value of the bitfield to be described by the [DESCRIPTION](#) attribute.

This attribute is a required part of the BFVALUE element.

You must enter a VALUE attribute in one of the following forms:

- decimal
- unsigned decimal
- hexadecimal (the value must begin with 0x or 0X)
- octal (the value must begin with 0)
- binary (the value must begin with 0b or 0B)
- character (enclosed in single quote marks, like this: 'c')

#### DESCRIPTION

This attribute lets you provide a description of the bitfield value specified by the VALUE attribute.

This attribute is a required part of the BFVALUE element.

You must enter a DESCRIPTION attribute in the form

*String*

where *String* represents the bitfield value description.

## Accessing the XML Files from CodeWarrior

The CodeWarrior Register Details window searches a specific folder for relevant files. You must place XML Register Details window files within the Registers folder in your CodeWarrior installation.

### Windows

If necessary, create the Registers folder at the following location:

```
<CodeWarrior>\Bin\Plugins\Support\Registers
```

## Register Details Window XML Specification

A Sample XML File

---

# A Sample XML File

This section provides examples of creating XML file for use with the Register Details window.

- [Creating the New XML File](#)
- [Adding Multiple BITFIELD Attributes](#)
- [Adding BFVALUE Attributes](#)
- [Completing the New XML File](#)

## Creating the New XML File

When you create a new file, you usually follow these high-level steps:

1. Locate a base XML file.

Instead of creating a completely new XML file, you can adapt an existing XML file for use with the register you wish to document. For example, you can locate a simple, generic XML file and modify it to describe more sophisticated registers.

[Listing 30.2](#) shows a sample base XML file that you can easily adapt to explain complex registers. Note that this generic base file lacks multiple bitfield attributes, conditional expressions, or individual bitfield value attributes.

### Listing 30.2 Sample Base XML File

---

```
<REGISTER NAME="BAR"

    BITRANGE="0:31"
    DESCRIPTION="Breakpoint Address Register">

    <BITFIELD BITRANGE="0:31"
        DESCRIPTION="The address of the load/store cycle that generates
the breakpoint.">
        </BITFIELD>

</REGISTER>
```

---

2. Save the base XML file under a new name.

Use CodeWarrior to save a copy of the base XML file under a new name, and work with this newly named file for the remainder of the process. This step prevents you from accidentally modifying the original XML file.

3. Modify the base XML file to suit your needs.

After opening your copy of the base XML file, you can adapt the file to accurately document complicated register properties. For example, you can add multiple BITFIELD attributes, BFVALUE attributes, and conditional expressions to the base XML file. The resulting file accurately and thoroughly describes the register. Such a file appears in [Listing 30.5](#).

## Adding Multiple BITFIELD Attributes

Multiple BITFIELD attributes divide the register into smaller ranges of bits, or “bitfields.” Such bitfields can have various meanings depending on the register. For example, one bitfield of a register could refer to condition flag information, while another bitfield in the same register could refer to current state information.

Suppose you wish to document a “Memory Controller Base 2” register that contains twelve bitfields. Each bitfield has its own name and description.

Using the sample base XML file of [Listing 30.2](#), you could begin adapting the file to your needs by adding eleven additional BITFIELD elements. Following the element formats described in the [Register Details Window XML Specification](#), your first revision of the base file might appear as shown in [Listing 30.3](#).

### Listing 30.3 First Revision of Base XML File

---

```
<REGISTER NAME="BR2"

    BITRANGE="0:31"
    DESCRIPTION="Memory Controller Base Register 2.">

    <BITFIELD BITRANGE="0:16"
        NAME="BA"
        DESCRIPTION="Place the BA bitfield description here.">
    </BITFIELD>

    <BITFIELD BITRANGE="17:19"
        NAME="AT"
        DESCRIPTION="Place the AT bitfield description here.">
    </BITFIELD>

    <BITFIELD BITRANGE="20:21"
        NAME="PS"
        DESCRIPTION="Place the PS bitfield description here.">
    </BITFIELD>

    <BITFIELD BITRANGE="22"
        NAME="-"
        DESCRIPTION="Make a note that this bitfield is reserved.">
```

## Register Details Window XML Specification

*A Sample XML File*

---

```

</BITFIELD>

<BITFIELD BITRANGE="23"
  NAME="WP"
  DESCRIPTION="Place the AT bitfield description here.">
</BITFIELD>

<BITFIELD BITRANGE="24:25"
  NAME="-"
  DESCRIPTION="Make a note that this bitfield is reserved.">
</BITFIELD>

<BITFIELD BITRANGE="26"
  NAME="WEBS"
  DESCRIPTION="Place the WEBS bitfield description here.">
</BITFIELD>

<BITFIELD BITRANGE="27"
  NAME="TBDIP"
  DESCRIPTION="Place the TBDIP bitfield description here.">
</BITFIELD>

<BITFIELD BITRANGE="28"
  NAME="LBDIP"
  DESCRIPTION="Place the LBDIP bitfield description here.">
</BITFIELD>

<BITFIELD BITRANGE="29"
  NAME="SETA"
  DESCRIPTION="Place the SETA bitfield description here.">
</BITFIELD>

<BITFIELD BITRANGE="30"
  NAME="BI"
  DESCRIPTION="Place the BI bitfield description here.">
</BITFIELD>

<
  <BITFIELD BITRANGE="31"
    NAME="V"
    DESCRIPTION="Place the V bitfield description here.">
  </BITFIELD>

</REGISTER>

```

---

---

## Adding BFVALUE Attributes

The values in an individual bitfield can describe different things about a register. For example, a bitfield value of 00 might indicate that a certain process is used, while a bitfield value of 01 might indicate that the same process is not used.

To cater your descriptions to accurately reflect such changes in behavior, you can use multiple BFVALUE attributes within a BITFIELD element. Each BFVALUE provides a specific description based on the bitfield value. CodeWarrior determines the applicable description to display in the Register Details window.

Using the example discussed in previous sections, assume that six of the bitfields in the "Memory Controller Base Register 2" could benefit from the use of BFVALUE attributes.

Following the element formats described in the [Register Details Window XML Specification](#), your second revision of the base file might resemble [Listing 30.4](#).

### Listing 30.4 Second Revision of XML Base File

---

```
<REGISTER NAME="BR2"

  BITRANGE="0:31"
  DESCRIPTION="Memory Controller Base Register 2.">

  <BITFIELD BITRANGE="0:16"
    NAME="BA"
    DESCRIPTION="Place the BA bitfield description here.">
  </BITFIELD>

  <BITFIELD BITRANGE="17:19"
    NAME="AT"
    DESCRIPTION="Place the AT bitfield description here.">
  </BITFIELD>

  <BITFIELD BITRANGE="20:21"
    NAME="PS"
    DESCRIPTION="Place the PS bitfield description here.">
    <BFVALUE VALUE="00" DESCRIPTION="Place the description of the
bitfield value of 00 here." />
    <BFVALUE VALUE="01" DESCRIPTION="Place the description of the
bitfield value of 01 here." />
    <BFVALUE VALUE="10" DESCRIPTION="Place the description of the
bitfield value of 10 here." />
    <BFVALUE VALUE="11" DESCRIPTION="Place the description of the
bitfield value of 11 here." />
  </BITFIELD>

  <BITFIELD BITRANGE="22"
    NAME="-" -
```

## Register Details Window XML Specification

### A Sample XML File

---

```

    DESCRIPTION="Make a note that this bitfield is reserved.">
</BITFIELD>

<BITFIELD BITRANGE="23"
    NAME="WP"
    DESCRIPTION="Place the AT bitfield description here.">
    <BFVALUE VALUE="0" DESCRIPTION="Place the description of the
bitfield value of 0 here." />
    <BFVALUE VALUE="1" DESCRIPTION="Place the description of the
bitfield value of 1 here." />
</BITFIELD>

<BITFIELD BITRANGE="24:25"
    NAME="-"
    DESCRIPTION="Make a note that this bitfield is reserved.">
</BITFIELD>

<BITFIELD BITRANGE="26"
    NAME="WEBS"
    DESCRIPTION="Place the WEBS bitfield description here.">
    <BFVALUE VALUE="0" DESCRIPTION="Place the description of the
bitfield value of 0 here." />
    <BFVALUE VALUE="1" DESCRIPTION="Place the description of the
bitfield value of 1 here." />
</BITFIELD>

<BITFIELD BITRANGE="27"
    NAME="TBDIP"
    DESCRIPTION="Place the TBDIP bitfield description here.">
</BITFIELD>

<BITFIELD BITRANGE="28"
    NAME="LBDIP"
    DESCRIPTION="Place the LBDIP bitfield description here.">
    <BFVALUE VALUE="0" DESCRIPTION="Place the description of the
bitfield value of 0 here." />
    <BFVALUE VALUE="1" DESCRIPTION="Place the description of the
bitfield value of 1 here." />
</BITFIELD>

<BITFIELD BITRANGE="29"
    NAME="SETA"
    DESCRIPTION="Place the SETA bitfield description here.">
    <BFVALUE VALUE="0" DESCRIPTION="Place the description of the
bitfield value of 0 here." />
    <BFVALUE VALUE="1" DESCRIPTION="Place the description of the
bitfield value of 1 here." />
</BITFIELD>

```

---

```

<BITFIELD BITRANGE="30"
  NAME="BI"
  DESCRIPTION="Place the BI bitfield description here.">
  <BFVALUE VALUE="0" DESCRIPTION="Place the description of the
bitfield value of 0 here." />
  <BFVALUE VALUE="1" DESCRIPTION="Place the description of the
bitfield value of 1 here." />
</BITFIELD>

<
  <BITFIELD BITRANGE="31"
    NAME="V"
    DESCRIPTION="Place the V bitfield description here.">
  </BITFIELD>

</REGISTER>

```

---

## Completing the New XML File

Adding multiple BITFIELD attributes and the BFVALUE attributes further refines the XML file register description. The final revision of an XML file involves completing the descriptions for each attribute.

Refining the example of previous sections, [Listing 30.5](#) shows the final XML file. To use this new file with the Register Details window, place the file in the Registers folder. For more information about this folder, refer to [Accessing the XML Files from CodeWarrior](#).

### Listing 30.5 Sophisticated XML File

---

```

<REGISTER NAME="BR2"

  BITRANGE="0:31"
  DESCRIPTION="Memory Controller Base Register 2.">

  <BITFIELD
    BITRANGE="0:16"
    NAME="BA"
    DESCRIPTION="Base Address. These bits are compared to the
corresponding unmasked address signals among ADDR[0:16] to determine
if a memory bank controlled by the memory controller is being accessed
by an internal bus master. (The address types are also compared.)
These bits are used in conjunction with the A<[0:16] bits in the OR">
  </BITFIELD>

```

---

## Register Details Window XML Specification

A Sample XML File

---

```

<BITFIELD
  BITRANGE="17:19"
  NAME="AT"
  DESCRIPTION="Address type. This field can be used to require
accesses of the memory bank to be limited to a certain address space
type. These bits are used in conjunction with ATM bits in the OR.">
</BITFIELD>

<BITFIELD
  BITRANGE="20:21"
  NAME="PS"
  DESCRIPTION="Port size.">
  <BFVALUE VALUE="00" DESCRIPTION="32-bit port" />
  <BFVALUE VALUE="01" DESCRIPTION="8-bit port" />
  <BFVALUE VALUE="10" DESCRIPTION="16-bit port" />
  <BFVALUE VALUE="11" DESCRIPTION="Reserved" />
</BITFIELD>

<BITFIELD
  BITRANGE="22"
  NAME="-"
  DESCRIPTION="Reserved.">
</BITFIELD>

<BITFIELD
  BITRANGE="23"
  NAME="WP"
  DESCRIPTION="Write protect. An attempt to write to the range of
addresses specified in a base address register that has this bit set
can cause the TEA signal to be asserted by the bus-monitor logic (if
enabled) causing termination of this cycle.">
  <BFVALUE VALUE="0" DESCRIPTION="Both read and write accesses
are allowed" />
  <BFVALUE VALUE="1" DESCRIPTION="Only read accesses are
allowed. The CSx signal and TA are not asserted by the memory
controller on write cycles to this memory bank. WPER is set in the
MSTAT register if a write to this memory bank is attempted." />
</BITFIELD>

<BITFIELD
  BITRANGE="24:25"
  NAME="-"
  DESCRIPTION="Reserved">
</BITFIELD>

<BITFIELD
  BITRANGE="26"
  NAME="WEBS"

```



```

        DESCRIPTION="Write-enable/byte select. This bit controls the
        functionality of the WE/BE pads.">
        <BFVALUE VALUE="0" DESCRIPTION="The WE/BE pads operate as WE"
    />
        <BFVALUE VALUE="1" DESCRIPTION="The WE/BE pads operate as BE"
    />
    </BITFIELD>

    <BITFIELD
        BITRANGE="27"
        NAME="TBDIP"
        DESCRIPTION="Toggle-burst data in progress. TBDIP determines how
        long the BDIP strobe will be asserted for each data beat in the burst
        of cycles.">
    </BITFIELD>

    <BITFIELD
        BITRANGE="28"
        NAME="LBDIP"
        DESCRIPTION="Late-burst-data-in-progress (LBDIP). This bit
        determines the timing of the first assertion of the BDIP pin in burst
        cycles. Note: It is not allowed to set both LBDIP and TBDIP bits in a
        region's base registers; the behavior of the design in such cases is
        unpredictable.">
        <BFVALUE VALUE="0" DESCRIPTION="Normal timing for BDIP
        assertion (assesrts one clock after negation of TS" />
        <BFVALUE VALUE="1" DESCRIPTION="Late timing for BDIP
        assertion (asserts after the programmed number of wait states" />
    </BITFIELD>

    <BITFIELD
        BITRANGE="29"
        NAME="SETA"
        DESCRIPTION="External transfer acknowledge.">
        <BFVALUE VALUE="0" DESCRIPTION="TA generated internally by
        memory controller" />
        <BFVALUE VALUE="1" DESCRIPTION="TA generated by external
        logic. Note that programming the timing of CS/WE OE strobes may have
        no meaning if this bit is set." />
    </BITFIELD>

    <BITFIELD
        BITRANGE="30"
        NAME="BI"
        DESCRIPTION="Burst inhibit. Note: Following a system reset, the BI
        bit is set in OR0.">
        <BFVALUE VALUE="0" DESCRIPTION="Memory controller drives BI
        negated (high). The bank supports burst accesses." />

```

## Register Details Window XML Specification

### References

---

```
<BFVALUE VALUE="1" DESCRIPTION="Memory controller drives BI
asserted (low). The bank does not support burst accesses." />
</BITFIELD>

<BITFIELD
  BITRANGE="31"
  NAME="V"
  DESCRIPTION="Valid bit. When set, this bit indicates that the
contents of the base-register and option-register pair are valid. The
CSignal does not assert until the V-bit is set. Note that an access to
a region that has no V-bit set may cause a bus monitor timeout. Note
also that following a system reset, the V-bit in BR0 reflects the
value of ID3 in the reset configuration word.">
</BITFIELD>

</REGISTER>
```

---

## References

For more information about XML, consult these references:

- *XML: A Primer*, by Simon St. Laurent, published by IDG Books Worldwide, Inc.
- *Presenting XML*, by Richard Light, published by Macmillan Computer Publishing.
- *The XML Companion*, by Neil Bradley, published by Addison-Wesley.

# Menus

---

This section contains these chapters:

- [IDE Menus](#)
- [Menu Commands](#)



# IDE Menus

---

This chapter is an overview of CodeWarrior™ IDE menus and their commands. The IDE menus are configurable in the **IDE Extras** preference panel.

This chapter lists the IDE menus under each menu layout. For each menu, a table shows this information:

- **Menu command**—the name of each command in the menu.
- **Description**—a short description of each command.

This section provides an overview of the menus and menu commands available in the **Windows** menu layout.

## File Menu

The **File** menu contains commands for opening, creating, saving, closing, and printing source files and projects. The File menu also provides different methods for saving edited files. [Table 31.1](#) explains the commands of this menu.

**Table 31.1** File Menu Commands

Menu command	Explanation
<a href="#">New</a>	Creates new projects using the New Project wizard or project stationery files.
<a href="#">Open</a>	Opens source and project files for editing and project modification operations.
<a href="#">Find and Open File</a>	Opens the file specified in the Find and Open File dialog or from the selected text in the active window.
<a href="#">Close</a>	Closes the active window.
<a href="#">Save</a>	Saves the active file using the editor window's filename.
<a href="#">Save All</a>	Saves all open editor windows.
<a href="#">Save As</a>	Saves a copy of the active file under a new name and closes the original file.
<a href="#">Save A Copy As</a>	Saves a copy of the active file without closing the file.

## IDE Menus

### Edit Menu

**Table 31.1 File Menu Commands (*continued*)**

Menu command	Explanation
<a href="#">Revert</a>	Discards all changes made to the active file since the last save operation.
<a href="#">Open Workspace</a>	Opens a workspace that you previously saved.
<a href="#">Close Workspace</a>	Closes the current workspace. (You cannot close the default workspace.)
<a href="#">Save Workspace</a>	Saves the current state of onscreen windows, recent items, and debugging.
<a href="#">Save Workspace As</a>	Saves an existing workspace under a different name.
<a href="#">Import Components</a>	Imports the components from another catalog into the current catalog.
<a href="#">Close Catalog</a>	Closes the current catalog and its associated Catalog Components window and Component Palette.
<a href="#">Import Project</a>	Imports a project file previously saved in extensible markup language format (XML) and converts it into project file format.
<a href="#">Export Project</a>	Exports the active project file to disk in extensible markup language (XML) format.
<a href="#">Page Setup</a>	Displays the Page Setup dialog for setting paper size, orientation, and other printer options.
<a href="#">Print</a>	Displays the Print dialog for printing active files, and the contents of Project, Message, and Errors & Warning window contents.
<a href="#">Open Recent</a>	Displays a submenu of recently opened files and projects that can be opened in the IDE.
<a href="#">Exit</a>	Quits the CodeWarrior IDE.

## Edit Menu

The **Edit** menu contains all customary editing commands, along with some CodeWarrior additions. This menu also includes commands that open the Preferences and Target Settings windows. [Table 31.2](#) explains the commands of this menu.

**Table 31.2 Edit Menu Commands**

Menu command	Explanation
<a href="#">Undo</a>	Undoes the last cut, paste, clear, or typing operation. If you cannot undo the action, this command changes to <b>Can't Undo</b> .
<a href="#">Redo</a>	Redoes the action of the last Undo operation. If you cannot redo the action, this command changes to <b>Can't Redo</b> .
<a href="#">Cut</a>	Removes the selected text and places a copy of it on the Clipboard.
<a href="#">Copy</a>	Copies the selected text and places a copy of it on the Clipboard.
<a href="#">Paste</a>	Places the contents of the Clipboard at current insertion point or replaces the selected text.
<a href="#">Remove</a>	Removes the selected text without placing a copy on the Clipboard.
<a href="#">Select All</a>	Selects all text in current editor window or text box for cut, copy, paste, clear, or typing operations.
<a href="#">Balance</a>	Selects text between the nearest set of parenthesis, braces, or brackets.
<a href="#">Shift Left</a>	Moves selected text one tab stop to the left.
<a href="#">Shift Right</a>	Moves selected text one tab stop to the right.
<a href="#">Get Previous Completion</a>	Shortcut for selecting the previous item that appears in the <b>Code Completion</b> window.
<a href="#">Get Next Completion</a>	Shortcut for selecting the next item that appears in the <b>Code Completion</b> window.
<a href="#">Complete Code</a>	Opens the <b>Code Completion</b> window.
<a href="#">Preferences</a>	Opens the IDE <b>Preferences</b> window where you can set general IDE, editor, debugger, and layout options.

## IDE Menus

### View Menu

**Table 31.2 Edit Menu Commands (continued)**

Menu command	Explanation
<a href="#">Target Settings</a> (the name changes, based on the name of the active build target)	Opens the project's <b>Target Settings</b> window where you can set target, language, code generation, linker, editor, and debugger options.
<a href="#">Version Control Settings</a>	Opens the <b>VCS Settings</b> window to enable activation of a version control system and its relevant settings.
<a href="#">Commands &amp; Key Bindings</a>	Opens the <b>Customize IDE Commands</b> window where you can create, modify, remove menus, menu commands, and key bindings.

## View Menu

The **View** menu contains commands for viewing toolbars, the class browser, the Message window, and debugging windows. [Table 31.3](#) explains the command of this menu.

**Table 31.3 View Menu Commands**

Menu command	Explanation
<a href="#">Toolbars</a>	Use the Toolbars menu to show, hide, reset, and clear window and main toolbars.
<a href="#">Object Inspector</a>	Opens or brings to the front an <b>Object Inspector</b> window.
<a href="#">Project Inspector</a>	Opens or brings to the front a <b>Project Inspector</b> window.
<a href="#">Browser Contents</a>	Opens or brings to the front a <b>Browser Contents</b> window.
<a href="#">Class Browser</a>	Opens or brings to the front a <b>New Class Browser</b> window.
<a href="#">Class Hierarchy or Class Hierarchy Window</a>	Opens or brings to the front a <b>Class Hierarchy</b> window.
<a href="#">Build Progress or Build Progress Window</a>	Opens the <b>Build Progress</b> window.
<a href="#">Errors &amp; Warnings or Errors &amp; Warnings Window</a>	Opens or brings to the front an <b>Errors &amp; Warnings</b> window.



Table 31.3 View Menu Commands (*continued*)

Menu command	Explanation
<a href="#">Symbolics or Symbolics Window</a>	Opens the <b>Symbolics</b> window.
System	Use the <b>System</b> menu to access the <b>Remote Connection</b> selected in the <b>Preferences</b> panel
<a href="#">Breakpoints or Breakpoints Window</a>	Opens or brings to the front the <b>Breakpoints</b> window. Use this window to view, create, modify, and remove breakpoints.
<a href="#">Registers or Register Window</a>	Opens or brings to the front a <b>Register</b> window.
Register Details	Opens or brings to the front a <b>Register Details</b> window.
<a href="#">Expressions or Expressions Window</a>	Opens or brings to the front an <b>Expressions</b> window. Use to view, create, modify, and remove expressions.
<a href="#">Global Variables or Global Variables Window</a>	Opens or brings to the front a <b>Global Variables</b> window.
Command Window	Opens a window containing a Command Line Interface.

## Search Menu

The **Search** menu contains commands for finding text, replacing text, comparing files, and navigating code. [Table 31.4](#) explains the commands of this menu.

Table 31.4 Search Menu Commands

Menu command	Explanation
<a href="#">Find</a>	Opens the <b>Find</b> window for performing searches in the active editor window.
<a href="#">Replace</a>	Opens the <b>Find and Replace</b> window for replacing text in the active editor window.
<a href="#">Find in Files</a>	Opens the <b>Find in Files</b> window for performing searches in the active editor window.
<a href="#">Find Next</a>	Finds the next occurrence of the find string in the active editor window.

**Table 31.4 Search Menu Commands (*continued*)**

<b>Menu command</b>	<b>Explanation</b>
<a href="#">Find In Next File</a>	Finds the next occurrence of the find string in the next file listed in the <b>Find</b> window's File Set.
<a href="#">Enter Find String</a>	Replaces the <b>Find</b> text box string with the selected text.
<a href="#">Find Selection</a>	Finds the next occurrence of the selected text in the active editor window.
<a href="#">Replace Selection</a>	Replaces the replace string in the <b>Replace</b> text box with the selected text.
<a href="#">Replace and Find Next</a>	Replaces the selected text with the <b>Replace</b> text box string, then performs a <b>Find Next</b> operation.
<a href="#">Replace All</a>	Finds all matches of the <b>Find</b> text box string and replaces them with the <b>Replace</b> text box string.
<a href="#">Find Definition</a>	Searches for definition of the routine name selected in the active editor window using the project's source files.
<a href="#">Go Back</a>	Returns to the previous CodeWarrior browser view.
<a href="#">Go Forward</a>	Moves to the next CodeWarrior browser view.
<a href="#">Go to Line</a>	Opens the <b>Go To Line</b> dialog where you can specify by line number where to position the text insertion point.
<a href="#">Compare Files</a>	Opens the <b>Compare Files Setup</b> window where you can choose to compare folders or files and merge their contents.
<a href="#">Apply Difference</a>	Adds, removes, or changes the selected text in the destination file to match the selected text in the source file.
<a href="#">Unapply Difference</a>	Reverses the modifications made to the destination file by the <b>Apply Difference</b> command.

## Project Menu

The **Project** menu contains commands for manipulating files, handling libraries, compiling projects, building projects, and linking projects. [Table 31.5](#) explains the commands of this menu.

**Table 31.5 Project Menu Commands**

<b>Menu command</b>	<b>Explanation</b>
<a href="#">Add Window</a>	Adds the active window to the project.
<a href="#">Add Files</a>	Opens a dialog box that you can use to add multiple files to the active project.
<a href="#">Create Group</a>	Opens the <b>Create Group</b> dialog box that you can use to add a new file group to the active project. The new file group appears below the selected file or group.
Create New Module	Opens the <b>Create Module</b> dialog box that you can use to create a Module.
<a href="#">Create Target</a>	Opens the <b>Create Target</b> dialog box that you can use to add a new build target to the active project. The new build target appears below the selected build target.
<a href="#">Create Overlay or Create Segment</a>	Opens the <b>Create Segment/Overlay</b> dialog box that you can use to add a new segment or overlay to the active project. The new segment or overlay appears below the selected one.
<a href="#">Create Design</a>	Opens the <b>Create New Design</b> dialog box that you can use to add a design to the active project. The new design appears in the <b>Design</b> tab of the project window.
<a href="#">Check Syntax</a>	Checks the active editor window or selected files in the project window for compilation errors.
<a href="#">Preprocess</a>	Preprocesses the active editor window or selected files in the project window and displays results in a new editor window.
<a href="#">Precompile</a>	Precompiles the active editor window or selected files in the project window and stores results in a new header file.
<a href="#">Compile</a>	Compiles the active editor window or selected files in the project window.
<a href="#">Disassemble</a>	Disassembles the active editor window or selected files in the project window and displays results in a new editor window.
<a href="#">Bring Up To Date</a>	Compiles all marked or modified files in the current build target of the active project.

## IDE Menus

### Debug Menu

**Table 31.5 Project Menu Commands (continued)**

Menu command	Explanation
<a href="#">Make</a>	Compiles and links all marked or modified files in the current build target of the active project, saving the executable file.
<a href="#">Stop Build</a>	Stops the current compile and linking operation and cancels the remainder of the build process.
<a href="#">Remove Object Code</a>	Removes object code from one or more build targets in the project.
<a href="#">Re-search for Files</a>	Resets the cached locations of source files using the project access paths, and stores them for faster builds and project operations.
<a href="#">Reset Project Entry Paths</a>	Resets the location of all source files in the active project using the project access paths.
<a href="#">Synchronize Modification Dates</a>	Updates the modification dates of all source files in the active project.
<a href="#">Debug</a> or <a href="#">Resume</a>	Compiles and links all marked or modified files in the current build target of the active window, then runs the built executable file.  Compiles and links all marked or modified files in the current build target of the active window, then runs the built executable file.
<a href="#">Run</a>	Compiles and links all marked or modified files in the current build target of the active window, then runs the built executable file.
<a href="#">Set Default Project</a>	Uses the Set Default Project menu to choose the default project when more than one project is open in the IDE.
<a href="#">Set Default Target</a>	Uses the Set Default Target menu to choose the default build target when more than one build target is present in the project file.

## Debug Menu

The **Debug** menu contains commands for managing program execution. [Table 31.6](#) explains the commands of this menu.

**Table 31.6 Debug Menu Commands**

<b>Menu command</b>	<b>Explanation</b>
<a href="#">Break</a>	Pauses execution of the program in a debugging session to enable examination of register and variable contents
<a href="#">Kill</a>	Terminates the current debugging session returning control to the IDE.
<a href="#">Restart</a>	Terminates the current debugging session, then restarts the program from the beginning.
<a href="#">Step Over</a>	Executes each source line in the program, treating routine calls as a single statement and stopping the program at the next line of code.
<a href="#">Step Into</a>	Executes each source line in the program, following any subroutine calls.
<a href="#">Step Out</a>	Executes each source line in the subroutine and stops the program when the routine returns to its caller.
<a href="#">Run to Cursor</a>	Sets a temporary breakpoint on the source line containing the insertion point.
<a href="#">Change Program Counter</a>	Opens the Change Program Counter dialog box that you can use to move the current statement arrow to an address or symbol.
<a href="#">Set Breakpoint</a> or <a href="#">Clear Breakpoint</a>	Sets a breakpoint on the source line containing the insertion point.  Clears the breakpoint on the source line containing the insertion point.
<a href="#">Set Eventpoint</a>	Sets an eventpoint on the source line containing the insertion point.
<a href="#">Clear Eventpoint</a>	Clears the breakpoint on the source line containing the insertion point.
<a href="#">Set/Clear Breakpoint</a>	Opens the Set/Clear Breakpoint dialog box that you can use for setting or clearing breakpoints by address or symbol.
<a href="#">Enable Breakpoint</a> or <a href="#">Disable Breakpoint</a>	Activates the disabled breakpoint on the source line containing the insertion point.  De-activates the breakpoint on the source line containing the insertion point.

## IDE Menus

### Debug Menu

Table 31.6 Debug Menu Commands (*continued*)

Menu command	Explanation
<a href="#">Clear All Breakpoints</a>	Clears all breakpoints currently set in the default build target of the active project.
<a href="#">Show Breakpoints</a> or <a href="#">Hide Breakpoints</a>	Adds a Breakpoint Column to all project editor windows where you can set, view, or clear breakpoints.  Removes the Breakpoint Column from all project editor windows.
Default Breakpoint Template	Allows the user to select the default breakpoint template from the templates listed. All user breakpoints created after this will use the selected template. The <b>Hardware</b> template is used to create a hardware breakpoint. The <b>Software</b> template is used to create a software breakpoint. The <b>Auto</b> option is used to automatically create a hardware or software breakpoint as deemed appropriate by the debugger. Usually an auto breakpoint means that the breakpoint will be a software breakpoint unless it cannot be - in which case the debugger will set a hardware breakpoint if it can. Usually the default is <b>Auto</b> .
Set Watchpoint Type	Sets the watchpoint type to be <code>Write</code> , <code>Read</code> , <code>Read Write</code> , or <code>Prompt</code> when set.
<a href="#">Set Watchpoint</a> or <a href="#">Clear Watchpoint</a>	Sets a watchpoint on the source line containing the insertion point.  Clears the watchpoint on the source line containing the insertion point.
<a href="#">Enable Watchpoint</a> or <a href="#">Disable Watchpoint</a>	Activates the disabled watchpoint on the source line containing the insertion point.  De-activates the watchpoint on the source line containing the insertion point.
<a href="#">Clear All Watchpoints</a>	Clears all watchpoints currently set in the default build target of the active project.
<a href="#">Break on C++ Exception</a>	Configures the debugger to break at <code>__throw()</code> each time a C++ exception occurs.

**Table 31.6 Debug Menu Commands (*continued*)**

Menu command	Explanation
Attach to Process	Use when a program is already running on the target hardware, and you want to start debugging the running program without disturbing its current state. Selecting <b>Attach to Process</b> starts the debugger and attaches it to the running process on the hardware. A thread window appears in whatever state the target is in (running, stopped, etc). The user can then proceed to debug the already running program using the symbolics and source code in the project that was used to attach.
<a href="#">Connect</a>	Establishes communication with an embedded device to start a debugging session.

## Data Menu

The **Data** menu contains commands that control how the CodeWarrior debugger displays data values. This menu appears only during a debugging session. [Table 31.7](#) explains the commands of this menu.

**Table 31.7 Data Menu Commands**

Menu command	Explanation
<a href="#">Show Types</a>	Toggles the appearance of the data type on local and global variables displayed in <b>Variable</b> panes and <b>Variable</b> windows.
<a href="#">Refresh All Data</a>	Updates data displays.
<a href="#">New Expression</a>	Creates a new expression entry in the <b>Expressions</b> window.
<a href="#">Copy to Expression</a>	Copies the selected variable to the <b>Expressions</b> window.
<a href="#">View As</a>	Displays the <b>View As</b> dialog where the data type of the selected variable can be specified.
<a href="#">View Variable</a>	Displays the selected variable in a new <b>Variables</b> window.
<a href="#">View Array</a>	Displays the selected array variable in a new <b>Arrays</b> window.
<a href="#">View Memory</a>	Displays the selected variable in a new <b>Memory</b> window.

## IDE Menus

### VCS Menu

**Table 31.7 Data Menu Commands (continued)**

Menu command	Explanation
<a href="#">View Memory As</a>	Displays the <b>View As</b> dialog where the data type of the selected variable can be specified, then shown in a new Memory window.
<a href="#">Cycle View</a>	Toggles the data view among <a href="#">View Source</a> , <a href="#">View Disassembly</a> , <a href="#">View Mixed</a> , and <a href="#">View Raw Data</a> .
<a href="#">View Source</a>	View data as source code.
<a href="#">View Disassembly</a>	View data as language disassembly.
<a href="#">View Mixed</a>	View data as source code and its disassembly.
<a href="#">View Raw Data</a>	View data without applied formatting.
<a href="#">View As Default</a>	Views the selected variable in the default value format.
<a href="#">View As Binary</a>	Views the selected variable as a binary value.
<a href="#">View As Signed Decimal</a>	Views the selected variable as a signed decimal value.
<a href="#">View As Unsigned Decimal</a>	Views the selected variable as an unsigned decimal value.
<a href="#">View As Hexadecimal</a>	Views the selected variable as a hexadecimal value.
<a href="#">View As Character</a>	Views the selected variable as a character value.
<a href="#">View As C String</a>	Views the selected variable as a C string.
<a href="#">View As Pascal String</a>	Views the selected variable as a Pascal string.
<a href="#">View As Unicode String</a>	Views the selected variable as a Unicode string.
<a href="#">View As Floating Point</a>	Views the selected variable as a floating point value.
<a href="#">View As Enumeration</a>	Views the selected variable as an enumerated value.
<a href="#">View As Fixed</a>	Views the selected variable as a 32-bit fixed value.

## VCS Menu

The VCS (Version Control System) menu appears in the IDE's menu bar when the **User Version Control** option is enabled in the **VCS Settings** panel. For a complete description of the VCS feature, see the `mwCVS.chm` help file included in your CodeWarrior product.



## Window Menu

The **Window** menu contains commands that manipulate IDE windows. [Table 31.8](#) explains the commands of this menu.

The Window menu also lists the names of all open file and project windows. A checkmark appears beside the active window; an underline indicates a modified and unsaved file.

**Table 31.8 Window Menu Commands**

Menu command	Explanation
<a href="#">Close</a>	Closes the active window.
<a href="#">Close All Editor Documents</a>	Closes all non-project windows.
<a href="#">Cascade</a>	Arranges all editor windows so that only the title bar is visible.
<a href="#">Tile Horizontally</a>	Tiles all editor windows horizontally on the screen so none overlap.
<a href="#">Tile Vertically</a>	Tiles all editor windows vertically on the screen so none overlap.
<a href="#">Save Default Window</a>	Saves the active browser windows settings and applies it to other browser windows as they are opened.

## Help Menu

The **Help** menu contains commands for accessing the IDE's online help. [Table 31.9](#) explains the commands of this menu.

**Table 31.9 Help Menu Commands**

Menu command	Explanation
<a href="#">CodeWarrior Help</a>	Launches a help viewer to display the online help. Click on a link to view a specific IDE topic.
Index	Launches a help viewer to display a glossary of common terms used in the CodeWarrior help and manuals.
Search	Launches a help viewer to a page for searching the CodeWarrior help and manuals.

## IDE Menus

### Help Menu

**Table 31.9 Help Menu Commands (continued)**

Menu command	Explanation
<a href="#">CodeWarrior Website</a>	Launches a browser and automatically points you to the web site.
<a href="#">About Freescale CodeWarrior</a>	Displays the CodeWarrior IDE version and build number information.

# Menu Commands

---

This section presents an alphabetical listing of all available menu commands in the CodeWarrior™ IDE. Menu commands that appear only on certain host platforms are documented. A menu command that has no host information is available on all hosts. Use this listing as a reference to find information about a specific menu command.

---

## A

### About Freescale CodeWarrior

This command displays the CodeWarrior IDE version and build number information.

---

**TIP** Click the **Installed Products** button in this window to view and save information about installed products and plugins for the CodeWarrior IDE. You can also use this window to enable or disable plugin diagnostics.

---

### Add Files

The **Add Files** command opens a dialog which allows one or more files to be added to the project.

### Add Window

The **Add Window** command adds the file in the active Editor window to the open project. The name of the menu command changes, based on the name of the active window. For example, if the name of the active window is `MyFile`, the name of the menu command changes to **Add MyFile to Project**.

### Align

Reveals the **Align** submenu with component alignment commands like Right Edges, Vertical Centers, and others.

See also:

## Menu Commands

---

- [Bottom Edges](#)
- [Horizontal Center](#)
- [Left Edges](#)
- [Right Edges](#)
- [To Grid](#)
- [Top Edges](#)
- [Vertical Center](#)

## All Exceptions

The **All Exceptions** command of the **Java** submenu tells the debugger to break every time an exception occurs. This behavior includes exceptions thrown by the virtual machine, your own classes, the debugger, classes in `classes.zip`, and so on. Java programs throw many exceptions in the normal course of execution, so catching all exceptions causes the debugger to break often.

## Anchor Floating Toolbar

The **Anchor Floating Toolbar** command attaches the floating toolbar beneath the menu bar. Once attached, the anchored toolbar can not be moved again until it is unanchored.

See also: [Unanchor Floating Toolbar](#)

## Apply Difference

The **Apply Difference** command applies the selected difference from the source file into the destination file.

## Attach to Process

Use when a program is already running on the target hardware, and you want to start debugging the running program without disturbing its current state. Selecting **Attach to Process** starts the debugger and attaches it to the running process on the hardware. A thread window appears in whatever state the target is in (running, stopped, etc). The user can then proceed to debug the already running program using the symbolics and source code in the project that was used to attach.

**B**

## Balance

The **Balance** command selects all text starting at the current insertion point and enclosed in parentheses ( ), brackets [ ], or braces { },

## Bottom Edges

The **Bottom Edges** command of the **Align** submenu aligns the bottom edges of the selected components.

## Break

The **Break** command temporarily suspends execution of the target program and returns control to the debugger.

See also: [Stop](#).

## Break on C++ Exception

The **Break on C++ Exception** command tells the debugger to break at `__throw()` each time a C++ exception occurs.

## Break on Java Exceptions

The **Break on Java Exceptions** command reveals the Java Exceptions submenu.

See also:

- [Exceptions in Targeted Classes](#)
- [Uncaught Exceptions Only](#).

## Breakpoints or Breakpoints Window

These commands open the Breakpoints window.

## Bring To Front

The **Bring To Front** command moves the selected objects so that they are displayed in front of all other objects.

## Bring Up To Date

The **Bring Up To Date** command updates the current build target in the active project by compiling all of the build target's modified and touched files.

## Browser Contents

The **Browser Contents** command opens the Browser Contents window. This command is not available if the Enable Browser option is not activated.

## Build Progress or Build Progress Window

These commands open the Build Progress window. Use it to monitor the IDE's status as it compiles a project.

---

## C

### Cascade

The **Cascade** command arranges open editor windows one on top of another, with their window titles visible.

### Change Program Counter

The **Change Program Counter** command opens a window that lets you move the current-statement arrow to a particular address or symbol.

### Check Syntax

The **Check Syntax** command checks the syntax of the source file in the active Editor window or the selected files in the open project window. If the IDE detects one or more errors, a Message window appears and shows information about the errors.

The **Check Syntax** command is not available if the active Editor window is empty or no project file is open.

**Check Syntax** does not generate object code.

To abort the syntax-checking process press Esc on your keyboard

## Class Browser

The **Class Browser** command opens a Class Browser window. This command is unavailable if the **Enable Browser** option is not enabled.

## Class Hierarchy or Class Hierarchy Window

These commands open a Multi-Class Browser window. This command is unavailable if the **Enable Browser** option is not enabled.

## Clear

The **Clear** command removes the selected text. This menu command is equivalent to pressing the Backspace or Delete key.

## Clear All Breakpoints

The **Clear All Breakpoints** command clears all breakpoints in all source files belonging to the target program.

## Clear All Watchpoints

The **Clear All Watchpoints** command clears all watchpoints in the current program.

## Clear Breakpoint

The **Clear Breakpoint** command clears the breakpoint at the currently selected line. If the **Show Breakpoints** option is enabled, the marker in the Breakpoints column of the Editor window disappears.

## Clear Eventpoint

This command opens a submenu that lets you remove an eventpoint from the currently selected line. If the **Show Breakpoints** option is active, the Breakpoints column in the editor windows shows a marker next to each line with an eventpoint. The marker represents the eventpoint type.

## Clear Floating Toolbar

The **Clear Floating Toolbar** command removes all shortcut icons from the floating toolbar. Once the toolbar is cleared, drag shortcut icons from the Commands and Key Bindings window to the toolbar to create a custom floating toolbar.

## Clear Main Toolbar

The **Clear Main Toolbar** command removes all shortcut icons from the main toolbar. Once the toolbar is cleared, drag shortcut icons from the Commands and Key Bindings window to the toolbar to create a custom main toolbar.

## Clear Watchpoint

The **Clear Watchpoint** command removes a watchpoint from the selected variable or memory range.

## Clear Window Toolbar

The **Clear Window Toolbar** command removes all shortcut icons from the window toolbar. Once the toolbar is cleared, drag shortcut icons from the Commands and Key Bindings window to the toolbar to create a custom window toolbar.

## Close

The **Close** command closes the active window.

## Close All

The **Close All** command closes all open windows of a certain type. The name of this menu command changes, based on the type of item selected. For example, select one of several open editor windows, the menu command changes its name to **Close All Editor Documents**.

## Close Catalog

The **Close Catalog** command closes the current catalog and removes the catalog from the Component Catalog window and the Component Palette.

## Close Workspace

This command closes the current workspace.

You cannot close the default workspace, but you can choose whether to use it by toggling the **Use Default Workspace** option in the [IDE Extras](#) preference panel.



## Commands & Key Bindings

The **Commands and Key Bindings** command opens the Customize IDE Commands window.

## Complete Code

The **Complete Code** command opens the Code Completion window. Use this window to help you automatically complete programming-language symbols as you type them in the active editor window.

## CodeWarrior Glossary

The **CodeWarrior Glossary** command opens and displays a list of vocabulary terms used by the CodeWarrior manuals and online help.

## CodeWarrior Help

This command opens the online help for the CodeWarrior IDE.

## CodeWarrior Website

The **CodeWarrior Website** command launches a web browser and displays the CodeWarrior web site.

## Collapse Window

The **Collapse Window** command collapses the active window so that only its title is visible.

## Compare Files

The **Compare Files** command opens the Compare Files Setup window. Use it to choose two files or folders for comparison and merging. After choosing the items, a comparison window appears that shows differences between the items.

## Command Window

Opens a window containing a Command Line Interface.

## Compile

The **Compile** command compiles selected source files into binary files. The IDE compiles source files that are:

- part of the current project and open in the active Editor window, or
- selected files, segments, or groups in a project window.

## Connect

The **Connect** command establishes communication between the IDE and embedded hardware to begin a debugging session.

## Copy

The **Copy** command copies selected text to the system Clipboard. If the Message Window is active, the Copy command copies all text in the Message Window to the Clipboard.

## Copy to Expression

The **Copy to Expression** command copies the variable selected in the active pane to the Expressions window.

## Create Design

This command creates a new design in the current project. The new design appears in the **Design** tab of the project window. You cannot create a design if each build target in the project already belongs to a design.

## Create Group

The **Create Group** command creates a new group in the current project. This command is active when the **Files** view is visible in the project window.

## Create New Module

Opens the **Create Module** dialog box that you can use to create a Module.

## Create Overlay or Create Segment

These commands create a new segment or overlay in the current project. This command is active when the **Segments** view or **Overlays** view is visible in the project window.

## Create Target

The **Create Target** command creates a new build target in the current project. This command is active when the **Targets** view is visible in the project window.

## Cut

The **Cut** command copies the selected text to the system Clipboard, replacing the previous Clipboard contents, and removes it from the current document or text box.

## Cycle View

Toggles view among various data formats.

See also:

- [View Disassembly](#)
- [View Mixed](#)
- [View Raw Data](#)
- [View Source](#)

---

## D

### Debug

This command compiles and links a project, then runs the CodeWarrior debugger with the project's code. If debugging is active, the debugging window appears to examine program information and step through the code as it executes. If debugging is not active, the window appears, but the program executes without stopping in the debugger.

### Default Breakpoint Template

Allows the user to select the default breakpoint template from the templates listed. All user breakpoints created after this will use the selected template. The **Hardware** template is used to create a hardware breakpoint. The **Software** template is used to create a software breakpoint. The **Auto** option is used to automatically create a hardware or software breakpoint as deemed appropriate by the debugger. Usually an auto breakpoint means that the breakpoint will be a software breakpoint unless it cannot be - in which case the debugger will set a hardware breakpoint if it can. Usually the default is **Auto**.

## Disable Breakpoint

The **Disable Breakpoint** command de-activates the breakpoint at the currently selected line.

## Disable Watchpoint

The **Disable Watchpoint** command de-activates a watchpoint for the selected variable or memory range.

## Disassemble

The **Disassemble** command disassembles the compiled source files selected in the project window. After disassembling a file, the IDE creates a `.dump` file that contains the file's object code. The `.dump` file appears in a new window after the IDE completes the disassembly process.

## Display Grid



The **Display Grid** command toggles the visibility of grid lines in the layout window. When checked, the grid lines appear, otherwise, no grid is visible.

---

## E

### Enable Breakpoint

The **Enable Breakpoint** command activates a breakpoint at the currently selected line. The breakpoint appears in the left side of the editor window if the Breakpoint column is visible. The states of the breakpoint marker include:

-  enabled breakpoint.
-  disabled breakpoint.
- - no breakpoint in line.

### Enable Watchpoint

The **Enable Watchpoint** command activates a watchpoint for the selected variable or memory range.

---

Enabled watchpoints are indicated by an underline of the selected variable or range of memory. Disabled watchpoints have a grey underline. The underline's color can be configured in the Display Settings preference panel of the IDE Preference window.

## Enter Find String

The **Enter Find String** command copies selected text in the active window directly into the target search string. It will then appear in the **Find** text box of both the **Find and Replace** and **Find in Files** windows. Once done, use any of the find commands to search for matches without opening any Find-related windows.

## Enter Replace String

The **Enter Replace String** command copies the selected text in the active window directly into the target search string. It will then appear in the **Replace with** text box of both the **Find and Replace** and **Find in Files** windows. Once done, use any of the find commands to search for matches without opening any Find-related windows.

## Errors & Warnings or Errors & Warnings Window

These commands open the Errors and Warnings window.

## Exceptions in Targeted Classes

The **Exceptions in Targeted Classes** command of the **Java** submenu instructs the debugger to break on exceptions thrown by your own classes in the project. Choose this command to break on exceptions thrown by your classes, rather than exceptions that Java programs throw in the normal course of execution.

## Exit

The **Exit** command exits the CodeWarrior IDE immediately, provided that:

- all changes to the open editor files are already saved, or
- the open editor files are not changed.

If a Project window is open, the IDE saves all changes to the project file before exiting. If an Editor window is open and changes are not saved, the CodeWarrior IDE asks if you want to save your changes before exiting.

## Expand Window

The **Expand Window** command expands a collapsed window (a window with only its title visible). Only available when a collapsed window is currently active.

## Export Project

The **Export Project** command exports a CodeWarrior project to a file in XML format. The IDE prompts for a name and location to save the new XML file.

## Expressions or Expressions Window

These commands open an Expressions window.

---

## F

### Find

The **Find** command opens the Find and Replace window to perform find operations within the active file.

### Find Definition & Reference

The **Find Definition & Reference** command searches for the definition of the selected routine name in the active Editor window. Searching starts within the source files belonging to the open project. If the IDE does not find a definition, a system beep sounds.

If the IDE does not find the routine definition within the project files, searching continues, using the online help system specified in the **IDE Extras** preference panel.

### Find Definition

The **Find Definition** command searches for the definition of the selected routine name in the active window. Searching occurs in the source files belonging to the open project. If the IDE finds the definition, the source file that contains the definition appears in an Editor window, and the routine name appears highlighted.

If the IDE finds more than one definition, a Message window appears warning of multiple definitions. If the IDE does not find a definition, a system beep sounds.

---

**NOTE** Select the **Activate Browser** option in the **Build Extras** target settings panel and re-compile the project in order to use the **Find Definition** command.

---

## Find in Files

The **Find in Files** command opens the Find in Files window. This window allows you to perform find-and-replace operations across multiple files using specified search criteria.

## Find In Next File

The **Find in Next File** command searches for the next occurrence of the **Find** text box string in the next file listed in the Find in Files window.

## Find In Previous File

This command searches for the next occurrence of the **Find** text box string in the previous file listed in the Find in Files window.

## Find Next

The **Find Next** command searches for the next occurrence of the Find text box string in the active window.

## Find and Open File

The **Find and Open File** command opens the Find and Open File dialog. Enter a filename, click OK, and the IDE searches the current project access paths as specified in the Access Paths panel of the Target Settings window.

## Find and Open 'Filename'

The **Find and Open 'Filename'** command opens an existing text file, using the currently selected text in the Editor window as the filename.

## Find Previous

The **Find Previous** command searches for the previous occurrence of the user defined string in the active window.

## Find Previous Selection

The **Find Previous Selection** searches for the previous occurrence of the selected text in the active editor window.

## Find Reference

The **Find Reference** command searches for the definition of the selected routine name in the active Editor window, using the online help system specified in the **IDE Extras** preference panel.

If the IDE does not find a definition, a system beep sounds.

## Find and Replace

The **Find and Replace** command opens the Find and Replace window. Use this window to perform find-and-replace operations within the active file.

## Find Selection

The **Find Selection** command searches for the next occurrence of the selected text in the active Editor window.

---

## G

### Get Next Completion

The **Get Next Completion** command acts as a shortcut that bypasses using the Code Completion window. Instead of scrolling through the Code Completion window to select the next symbol from the one currently selected, use this command to insert that next symbol directly into the active editor window.

### Get Previous Completion

The **Get Previous Completion** command acts as a shortcut that bypasses using the Code Completion window. Instead of scrolling through the Code Completion window to select the previous symbol from the one currently selected, use this command to insert that previous symbol directly into the active editor window.

### Global Variables or Global Variables Window

These commands open the Global Variables window. Use this window to view global variables for an entire project or for a single file. Click a filename in the **Files** list to display the file's global variables in the **Variables** list.



## Go Back

The **Go Back** command returns to the previous view in the CodeWarrior browser.

## Go Forward

The **Go Forward** command moves to the next view in the CodeWarrior Browser (after you select **Go Back** command to return to previous view).

## Go to Line

The **Go to Line** command opens the **Line Number** dialog box. Enter a specific line number to move the text-insertion point. If the line number specified exceeds the number of lines in the file, the text-insertion point moves to the last line in the file.

---

## H

### Hide Breakpoints

The **Hide Breakpoints** command conceals the Breakpoints column, which appears to the left of the source code shown in editor windows.

### Hide Floating Toolbar

The **Hide Floating Toolbar** command conceals the IDE's floating toolbar. After concealing the floating toolbar, the command changes to **Show Floating Toolbar**.

### Hide Main Toolbar

The **Hide Main Toolbar** command conceals the IDE's main toolbar. After concealing the main toolbar, the command changes to **Show Main Toolbar**.

### Hide Window Toolbar

The **Hide Window Toolbar** command conceals the toolbar in the active window. After concealing the window toolbar, the command changes to **Show Window Toolbar**.

## Menu Commands

---

### Horizontal Center

The **Horizontal Center** command of the **Align** submenu aligns the horizontal centers of the selected components.

---

## I

### Import Components

The **Import Components** command imports components from another catalog for use with the current catalog.

### Import Project

The **Import Project** command imports project files previously saved in a XML file with the **Export Project** command.

### Insert Reference Template

This command inserts a routine template corresponding to the selected Mac OS Toolbox call in the active window. The IDE uses the online reference database application specified in the **Find Reference Using** pop-up to search for the routine's definition.

---

## K-L

### Kill

The **Kill** command terminates the target program and returns control to the debugger.

### Left Edges

The **Left Edges** command of the **Align** submenu aligns the left edges of the selected components.

---

## M-N

### Make

The **Make** command builds the selected project by compiling and linking its modified and touched files. The results of a successful build depend on the selected project type.

### Maximize Window

Windows equivalent of Expand Window.

See also: [Expand Window](#)

### Minimize Window

Windows equivalent of Collapse Window.

See also: [Collapse Window](#)

### New

The **New** command opens the **New** window. Use the **New** window to create new projects, files, components, and objects.

### New Class

The **New Class** command opens the New Class wizard. Use this wizard to help create new classes in a project.

### New Class Browser

The **New Class Browser** command opens a Browser window. The IDE grays out this menu command if the CodeWarrior browser is not activated. This menu command is equivalent to the **Class Browser** menu command.

### New Data Member

The **New Data Member** command opens the New Data Member wizard. Use this wizard to help create new data members for a class.

## New Event

The **New Event** command opens the New Event window. Use this window to help create new events for a selected class in a project.

## New Event Set

The **New Event Set** command opens the New Event Set window to create a new event set for a selected class in a project.

## New Expression

The **New Expression** command creates a new entry in the Expressions window, prompting entry of a new expression.

## New Member Function

The **New Member Function** command opens the New Member Function wizard. Use this wizard to help create new member functions for a class.

## New Method

The **New Method** command opens the New Method window. Use this window to create a new method for a selected class in a project.

## New Property

The **New Property** command opens the New Property window. Use this window to create a new property for a selected class in a project.

## New Text File

The **New Text File** command creates a new editable text file and opens an editor window.

## No Exceptions

The **No Exceptions** command of the **Java** submenu instructs the debugger to not break when exceptions occur.

## O

### Object Inspector

Opens the Object Inspector window so that you can view property and event information about your project.

### Open

The **Open** command opens an existing project or source file.

### Open Recent

The **Open Recent** menu item reveals a submenu of recently opened projects and files. Choose a file from the submenu to open that item.

If two or more files in the submenu have identical names, the submenu shows the full paths to those files in order to distinguish between them.

### Open Scripts Folder

This command opens the (`Scripts`) folder. This command is only available if the **Use Scripts menu** option is enabled.

### Open Workspace

This command opens a workspace file that you previously saved.

---

## P-Q

### Page Setup

The **Page Setup** command sets the options used for printing CodeWarrior IDE files.

## Paste

The **Paste** command replaces the selected text with contents of the system clipboard into the active Editor window or text box. If no text is selected, the IDE places the clipboard contents at the text-insertion point.

The **Paste** command is unavailable if the Message window is active.

## Precompile

The **Precompile** command precompiles the text file in the active Editor window into a precompiled header file.

## Preferences

The **Preferences** command opens the IDE Preferences window. Use this window to change the global preferences used by the CodeWarrior IDE.

## Preprocess

This command preprocesses selected source files in any language that has a preprocessor, such as C, C++, and Java.

## Print

The **Print** command prints CodeWarrior IDE files, as well as Project, Message, and Errors and Warnings window contents.

## Processes or Processes Window

These commands open the Processes window for those platforms that support it.

## Project Inspector

Opens the Project Inspector window so that you can view information about your project. You can also use this window to manipulate file-specific information.

## Quit or Quit CodeWarrior

Mac OS command equivalent of [Exit](#): See [Exit](#).

## R

### Redo

After undoing an operation, you can redo it. For example, after choosing the **Undo Typing** command to remove some text that you typed, you can choose **Redo Typing** to override the undo and restore the text.

You can enable the **Use multiple undo** option in the **Editor Settings** preference panel to allow greater flexibility with regard to **Undo** and **Redo** operations. After enabling this option, you can choose **Undo** multiple times to undo multiple actions, and you can **Redo** multiple times to redo multiple actions.

### Refresh All Data

This command updates the data that appears in all windows.

### Register Details Window

The **Register Details Window** command opens the Register Details window, which allows you to view descriptions of registers, bit fields, and bit values.

### Registers or Register Window

These commands reveal the Registers submenu, which can be used to view general registers or FPU registers.

See also: [Register Details Window](#)

### Register Details Window

Opens or brings to the front a **Register Details** window.

### Remove

The **Remove** command removes selected text without placing it on the system clipboard. This menu command is equivalent to pressing the Backspace or Delete key.

## Remove Object Code

The **Remove Object Code** command shows the Remove Object Code dialog box. Use this dialog box to remove binary object code from the active project, or to mark the project's files for re-compilation.

## Remove Object Code & Compact

This command removes all binaries from the project and compacts it. Compacting the project removes all binary and debugging information and retains only the information regarding the files that belong to the project and project settings.

## Remove Selected Items

The **Remove Selected Items** command removes the currently selected items from the Project window.

---

**CAUTION** You cannot undo this command.

---

## Replace

The **Replace** command opens the Find and Replace dialog box. Use this dialog box to perform find-and-replace operations within the active file.

## Replace All

The **Replace All** command finds all occurrences of the **Find** string and replaces them with the **Replace** string. If no text is selected in the active Editor window and there is no text in the **Find** text box, the IDE dims this menu command.

## Replace and Find Next

This command substitutes selected text with text in the **Replace** text box of the Find window, and then performs a **Find Next** operation. If no text is selected in the active Editor window and there is no text in the Find field of the Find window, the IDE grays out this menu command.

## Replace and Find Previous

This command substitutes selected text with the text in the **Replace** text box of the Find window, and then performs a **Find Previous** operation. If no text is selected in the active



---

Editor window and there is no text in the Find field of the Find window, the IDE grays out this menu command.

---

**NOTE** (Mac OS) Press the Shift key to change the Replace and Find Next menu command to the Replace and Find Previous menu command.

---

## Replace Selection

The **Replace Selection** command substitutes the selected text in the active window with the text in the **Replace** text box of the Find window. If no text is selected in the active Editor window, the IDE grays out the menu command.

This menu command replaces one instance of a text string without having to open the Find window. Suppose that you replaced all occurrences of the variable `icount` with `jcount`. While scrolling through your source code, you notice an instance of the variable `icount` misspelled as `icont`. To replace this misspelled variable with `jcount`, select `icont` and the **Replace Selection** menu command.

## Re-search for Files

The **Project > Re-search for Files** command speeds up builds and other project operations, the IDE caches the location of project files after finding them in the access paths. **Re-search for Files** forces the IDE to forget the cached locations and re-search for them in the access paths. This command is useful if you moved several files and you want the IDE to find the files in their new locations.

If the **Save project entries using relative paths** option is enabled, the IDE does not reset the relative-path information stored with each project entry, so re-searching for files finds the source files in the same location (the exception is if the file no longer exists in the old location). In this case, the IDE only re-searches for header files. To force the IDE to also re-search for source files, choose the **Project > Reset Project Entry Paths** menu command.

If the **Save project entries using relative paths** option is disabled, the IDE re-searches for both header files and source files.

## Reset

The **Reset** command resets the program and returns control to the IDE.

## Reset Floating Toolbar

The **Reset Floating Toolbar** command restores the default state of the floating toolbar. Use this command to return the floating toolbar to its original default settings.

## Reset Main Toolbar

The **Reset Main Toolbar** command restores the default state of the main toolbar. Use this command to return the main toolbar to its original default settings.

## Reset Project Entry Paths

The **Reset Project Entry Paths** command resets the location information stored with each project entry and forces the IDE to re-search for the project entries in the access paths. This command does nothing if the **Save project entries using relative paths** option is disabled.

## Reset Window Toolbar

The **Reset Window Toolbar** command restores the default state of the toolbar in the active window. Use this command to return the toolbar to its original default settings.

## Resize

The **Resize** command reveals the Resize submenu.

See also:

- [To Largest Height](#)
- [To Largest Width](#)
- [To Smallest Height](#)
- [To Smallest Width](#)

## Restart

The **Restart** command terminates the current debugging session, then starts a new debugging session.

## Restore Window

The **Restore Window** command restores a minimized window (a window reduced to an item in the task bar).

## Resume

The **Resume** command switches from the IDE to the running application. This menu command only appears after the IDE starts a debugging session and the application being debugged is currently running.

## Revert

The **Revert** command restores the last saved version of the active Editor window.

## Right Edges

The **Right Edges** command of the **Align** submenu aligns the right edges of the selected components.

## Run

The **Run** command compiles, links, creates a standalone application, and then runs that application. This command is unavailable if the project creates libraries, shared libraries, code resources, and other non-application binaries.

## Run to Cursor

The **Run to Cursor** command sets a temporary breakpoint at the line of source code that has the text-insertion point, then runs the program.

---

## S

### Save

The **Save** command saves the contents of the active window to disk.

### Save A Copy As

The **Save A Copy As** command saves the active window to a separate file. This command operates in different ways, depending on the active window.

### Save All

The **Save All** command saves all currently open editor files.

---

**NOTE** Mac OS: Press the Option key to change the Save command to the Save All menu command.

---

## Save As

The **Save As** command saves the contents of the active window to disk under a different name.

## Save Default Window

This command saves the window settings, such as position and size, of the active Browser or Search Results window. The IDE applies the saved settings to subsequently opened windows.

## Save Workspace

This command saves the current state of onscreen windows, recent items, and debugging. Use the dialog box that appears to name the workspace and navigate to a location in which to store the workspace file.

## Save Workspace As

This command saves a copy of an existing workspace. Use this command to save the workspace under a different name.

## Select All

The **Select All** command selects all text in the active window or text box. This command is usually used in conjunction with other **Edit** menu commands such as Cut, Copy, and Clear.

## Send To Back

The **Send To Back** command moves the selected window behind all other windows.

## Set Breakpoint

The **Set Breakpoint** command sets a breakpoint at the currently selected line. If the **Show Breakpoints** option is active, the Breakpoints column in the editor windows will display a marker next to each line with a breakpoint.

## Set/Clear Breakpoint

The **Set/Clear Breakpoint** command displays the **Set/Clear Breakpoints** dialog that lets you set or clear a breakpoint at a particular address or symbol.

## Set Default Project

The **Set Default Project** command sets a particular project as the default project when more than one project is open. This is the project that all commands are directed.

## Set Default Target

The **Set Default Target** command allows you to specify a different build target within the current project. Choose the build target to work with from the submenu. This menu command is useful for switching between multiple build targets in a project and performing a build for each target.

## Set Eventpoint

This command opens a submenu that lets you set an eventpoint at the currently selected line. If the **Show Breakpoints** option is enabled, the Breakpoints column in the editor windows shows a marker next to each line with an eventpoint. The marker represents the eventpoint type.

## Set Watchpoint

The **Set Watchpoint** command sets a watchpoint for the selected variable or memory range. Watchpoint variables are identified using an underline.

## Set Watchpoint Type

Sets the watchpoint type to be `Write`, `Read`, `Read Write`, or `Prompt when set`.

## Shift Left

The **Shift Left** command shifts the selected source code one tab to the left. The amount of shift is controlled by the **Tab Size** option.

## Shift Right

The **Shift Right** command shifts the selected source code one tab to the right. The amount of shift is controlled by the **Tab Size** option.

## Show Breakpoints

The **Show Breakpoints** command displays the Breakpoints column in editor windows. When active, the Breakpoints column appears along the left edge of all editor windows.

## Show Floating Toolbar

The **Show Floating Toolbar** command displays the IDE's floating toolbar. After displaying the floating toolbar, the command changes to Hide Floating Toolbar.

## Show Main Toolbar

The **Show Main Toolbar** command displays the IDE's main toolbar. After displaying the main toolbar, the command changes to Hide Main Toolbar.

## Show Types

The **Show Types** command displays the data types of all local and global variables that appear in the active variable pane or variable window.

## Show Window Toolbar

The **Show Window Toolbar** command displays the toolbar in the active window. After displaying the window toolbar, the command changes to Hide Window Toolbar.

## Stack Editor Windows

The **Stack Editor Windows** command arranges open editor windows one on top of another, with their window titles visible.

## Step Into

The **Step Into** command executes a single statement, stepping into function calls.

## Step Out

The **Step Out** command executes the remainder of the current function, then exits to that function's caller.

## Step Over

The **Step Over** command executes a single statement, stepping over function calls.

## Stop

This command temporarily suspends execution of the target program and returns control to the debugger.

## Stop Build

The **Stop Build** command halts the build currently in progress.

## Switch to Monitor

This command transfers control from the CodeWarrior debugger to an external third-party debugger.

## Symbolics or Symbolics Window

These commands open the Symbolics window. Use this window to examine the executable files in a project.

## Synchronize Modification Dates

The **Synchronize Modification Dates** command updates the modification dates stored in the project file. The IDE checks the modification date of each file in the project and marks (for recompiling) those files modified since the last successful compile process.

## System

Use the **System** menu to access the **Remote Connection** selected in the **Preferences** panel

---

## T-U

## Target Settings

The **Target Settings** command displays the Target Settings window. This window contains settings panels used by the active build target. The name of the menu command changes, based on the name of the current build target. For example, if the name of the current build target is `ReleaseTarget`, the name of the menu command changes to **ReleaseTarget Settings**.

## Tile Editor Windows

The **Tile Editor Windows** command arranges and resizes all open editor windows so that none overlap on the monitor, as [Figure 32.1](#) shows.

**Figure 32.1** Tile Editor Windows Example

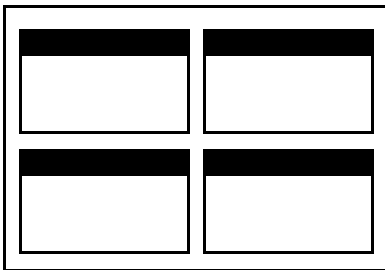

## Tile Editor Windows Vertically

The **Tile Editor Windows Vertically** command resizes all open editor windows to be vertically long, and arranged horizontally across the monitor so that all are viewable.

## Tile Horizontally

This command arranges open editor windows horizontally so that none overlap, as [Figure 32.2](#) shows.

**Figure 32.2** Tile Horizontally Example

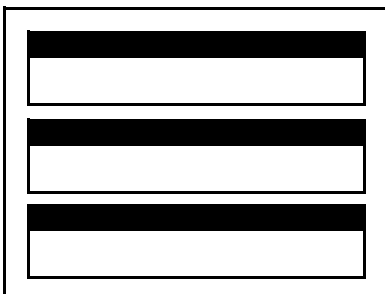

## Tile Vertically

This command resizes open editor windows vertically and arranges them so that none overlap, as [Figure 32.3](#) shows.



---

Figure 32.3 Tile Vertically Example

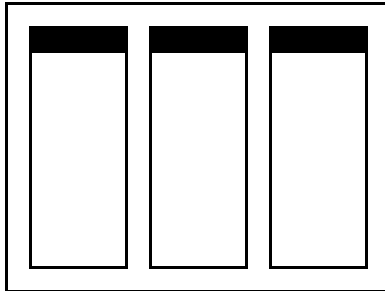

## To Grid

The **To Grid** command of the **Align** submenu aligns selected components to a grid in the layout. You can display or hide the on screen grid.

## To Largest Height

The **To Largest Height** command of the **Resize** submenu resizes the selected components to match the height of the component with the largest height.

## To Largest Width

The **To Largest Width** command of the **Resize** submenu resizes the selected components to match the width of the component with the largest width.

## Toolbars

The **Toolbars** command reveals the Toolbars submenu.

See also:

- [Show Window Toolbar](#)
- [Hide Window Toolbar](#)
- [Reset Window Toolbar](#)
- [Clear Window Toolbar](#)
- [Show Main Toolbar](#)
- [Hide Main Toolbar](#)
- [Reset Main Toolbar](#)
- [Clear Main Toolbar](#)

## Menu Commands

---

- [Hide Floating Toolbar](#)
- [Show Floating Toolbar](#)
- [Reset Floating Toolbar](#)
- [Clear Floating Toolbar](#)

## ToolServer Worksheet

The **ToolServer Worksheet** command opens the ToolServer Worksheet window for use with the Apple® ToolServer™ application program.

The IDE can disable this command for these reasons:

- You did not install ToolServer on your computer.
- You installed ToolServer on your computer, but you did not start it.

## Top Edges

The **Top Edges** command of the **Align** submenu aligns the top edges of the selected components.

## To Smallest Height

The **To Smallest Height** command of the **Resize** submenu resizes the selected components to match the height of the component with the smallest height.

## To Smallest Width

The **To Smallest Width** command of the **Resize** submenu resizes selected components to match the width of the component with the smallest width.

## Unanchor Floating Toolbar

The **Unanchor Floating Toolbar** command detaches the floating toolbar from beneath the menu bar.

## Unapply Difference

The **Unapply Difference** command reverses the action of the **Apply Difference** command in a file-comparison window.

## Uncaught Exceptions Only

The **Uncaught Exceptions Only** command of the **Java** submenu instructs the debugger to break only on unhandled exceptions.

## Undo

The **Undo** command reverses the last action. The name of this menu command changes based upon the editor settings as well as the most recent action. For example, after typing text in an open Editor window, the **Undo** command changes its name to **Undo Typing**. Choose the **Undo Typing** command to remove the typed text.

By default, only one undo or redo action is allowed. If the **Use multiple undo** option is enabled, undo and redo can act upon multiple actions.

## Ungroup

The **Ungroup** command separates a selected group so that you can move each component independently.

---

## V-Z

### Version Control Settings

The **Version Control Settings** command opens the VCS Settings window.

### Vertical Center

The **Vertical Center** command of the **Align** submenu aligns the vertical centers of the selected components.

### View Array

The **View Array** command creates a separate window to display a selected array.

### View As

The **View As** command displays a selected variable in a specified data type.

## View As Binary

The **View As Binary** command displays the selected variable as a binary value.

## View As Character

The **View As Character** command displays the selected variable as a character value.

## View As C String

The **View As C String** command displays the selected variable as a C character string.

## View As Default

The **View As Default** command displays the selected variable in its default format, based on the variable's type.

## View As Enumeration

The **View As Enumeration** command displays the selected variable as an enumeration.

## View As Fixed

The **View As Fixed** command displays the selected variable as a fixed-type numerical value.

## View As Floating Point

The **View As Floating Point** command displays the selected variable as a floating-point value.

## View As Fract

This command displays the selected variable as a fractional data type.

---

**NOTE** The fractional data type is specific to the Mac OS.

---

## View As Hexadecimal

The **View As Hexadecimal** command displays the selected variable as a hexadecimal value.

## View As Pascal String

The **View As Pascal String** command displays the selected variable as a Pascal character string.

## View As Signed Decimal

This command displays the selected variable as a signed decimal value.

## View As Unicode String

The **View As Unicode String** command displays the selected variable as a Unicode character string.

## View As Unsigned Decimal

The **View As Unsigned Decimal** command displays the selected variable as an unsigned decimal value.

## View Disassembly

This command changes the data view to show language disassembly.

## View Memory

The **View Memory** command displays the contents of memory as a hexadecimal/ASCII character dump.

## View Memory As

The **View Memory As** command displays the memory that a selected variable occupies or the memory to which a selected register points.

## View Mixed

This command changes the data view to show source code intermixed with assembly code.

## View Raw Data

This command changes the data view to show raw data (instead of formatting that data as source code, disassembly, or another format).

## Menu Commands

---

### **View Source**

This command changes the data view to show source code.

### **View Variable**

The **View Variable** command creates a separate window to display a selected variable.

### **Zoom Window**

The **Zoom Window** command expands the active window to its previously set size. Choose **Zoom Window** a second time to return the window to its original size.

# Index

## Symbols

#if-#endif 286  
 #pragma  
     dont\_inline 284  
     profile 285  
 #pragma directives, profiler 285  
 \$ 452  
 \$\$ 455  
 %file command-line string 425  
 %line command-line string 425  
 (Scripts) folder 501  
 .\*[\_]Data 362  
 .mcp 35  
 \(.\*\) 361  
 ^var 235  
 \_\_copy\_vectors() 288  
 \_\_PROFILE\_ENTRY 276  
 \_\_PROFILE\_EXIT 276  
 \_\_throw() 485

## A

abnormal termination 275  
 about  
     breakpoints 203  
     console applications 79  
     dockable windows 65  
     eventpoints 203  
     Files page in Project window 45  
     markers 110  
     projects 29  
     special breakpoints 203  
     watchpoints 203  
     workspaces 75  
 About Freescale CodeWarrior menu  
     command 483  
 Absolute Path option  
     in Source Trees preference panel 441  
     in Type list box 441  
 abstract, icon for 163  
 ACCESS 454  
 access breakpoint - refer to watchpoints 225

access breakpoint enabled 225  
 Access Filter display 165  
 Access Paths settings panel 360, 389  
     columns  
         Recursive Search 391  
         Search Status 390  
     options  
         Add 390  
         Add Default 390  
         Always Search User Paths 389  
         Change 390  
         Host Flags 390  
         Remove 390  
         System Paths 440  
         User Paths 445  
 Access Target button 310  
 Action 335  
 actions for debugging 192  
 Activate Browser Coloring option 409  
     in Text Colors panel 422  
 Activate Browser option  
     and relation to Symbolics window 255  
     in Build Extras panel 494  
 Activate Syntax Coloring option 409, 414  
     in Text Colors panel 422, 425, 438  
 activating automatic code completion 98  
 Active icon 207  
 Add button 390  
 Add Default button 409  
 Add Files button 129  
 Add Files menu command 483  
 Add Window menu command 483  
 adding  
     gray background behind IDE. *See Use Multiple Document Interface, turning on.*  
     remote connections 382  
     source trees 363  
 ADDRESS 452  
 Address checkbox 313  
 Address Line fault 315  
 Address text box 250  
 advanced topics

- 
- for projects 38
  - Align submenu 483, 485, 498, 507, 513, 514, 515
    - Horizontal Center command 498
    - Left Edges command 498
    - Vertical Center command 507, 513, 514, 515
  - All Exceptions command 484
  - All Info option, in Plugin Diagnostics 426
  - All Sectors checkbox 303
  - All Sectors list 303
  - All Targets 328
  - All Text option button 116, 119, 122
  - alphabetical sorting of Functions list pop-up 108, 109
  - Always Search User Paths option 409
  - Ancestor pop-up 168
  - Anchor Floating Toolbar command 484
  - AND 452
  - Appears in Menus 335, 336
  - Appears in Menus checkbox 133
  - Application field 410
  - applications 329
    - for the console, about 79
    - for the console, creating 79
  - Apply Address Offset checkbox 301
  - Apply button 142
  - Apply Difference command 143, 484, 514
  - Arguments field 410
  - Arithmetic Optimizations 399
  - Array window 243
    - opening 245
  - arrays, setting default viewing size for
    - unbounded 416
  - arrows
    - current statement 191
  - assigning
    - Quote Key prefix 349
  - Attempt To Use Dynamic Type of C++, Object
    - Pascal And SOM Objects option 410
  - attribute
    - ACCESS 454
    - ADDRESS 452
    - BITRANGE 451, 453
    - CONDITION 455
    - DESCRIPTION 452, 456, 457
    - FORMAT 454
    - NAME 451, 453
    - RESETVALUE 452
    - VALUE 457
  - attributes
    - adding 459
  - Auto Indent option 410
  - Auto Repeat 335
  - Auto Target Libraries option 410
  - Auto, of Text View list box 253
  - auto-complete code. *See* code completion.
  - Automatic Invocation option 410
  - Automatically Launch Applications When SYM
    - File Opened option 411
  - Auto-target Libraries option 410
- ## B
- Background option 411
  - background, desktop
    - removing from behind IDE. *See* Use Multiple Document Interface, turning on.
    - seeing behind IDE. *See* Use Multiple Document Interface, turning off.
  - Balance Flash Delay option 411
    - Editor Settings panel 412
  - Balance menu command 485
  - Balance While Typing option 411, 412
  - balancing punctuation 96
    - toggling 97
  - Balloon Help 418
  - Base Classes field 178
  - Begin Scope Loop button 312
  - Begin Test button 314
  - bestTimeBase 274, 287
  - BFVALUE 456
    - adding attributes 459
  - BFVALUE 456
  - binary 450, 454, 457
  - binary file 329
  - binary files 327
    - Make 327
  - Bit Value Modifier list box 251
  - Bit Value text box 251
  - BITFIELD 453, 456
-



- 
- multiple attributes 459
  - BITFIELD 453
  - Bitfield Description option
    - of Text View pop-up menu 253
  - Bitfield Name list box 250
  - BITRANGE 451, 453
  - Blank Check button 304
  - boolean 452
  - Bottom Edges command 485
  - boxes
    - Destination 138
    - Pane Collapse 145, 190
    - Pane Expand 145, 190
    - Source 138
  - Branch Optimizations 399
  - Break command 194
  - Break menu command 485
  - Break On C++ Exception menu command 485
  - Break on Java Exceptions command 485
  - Breakpoint Properties button 206
  - breakpoint template 213
  - breakpoint template, defined 204
  - breakpoint templates
    - creating 213
    - deleting 214
    - specifying the default 214
    - working with 213
  - Breakpoints 204
  - breakpoints
    - Breakpoint Type property 209
    - clearing all 211
    - Condition property 209
    - conditional 204
    - default template 213
    - defined 203
    - disabled 204, 225
    - enabled 204
    - File-Info property 209
    - Hit Count property 209
    - Name property 209
    - Original Process property 210
    - Original-Target property 210
    - purpose of 203
    - regular 203
    - saving sets of 208
    - Serial Number property 209
    - setting conditional 211
    - setting temporary 211
    - template 213
    - temporary 204
    - Thread property 210
    - thread-specific 212
    - Times Left property 210
    - viewing 207
    - working with 208
  - Breakpoints button 190
  - Breakpoints column, in editor window 90
  - Breakpoints menu command 485
  - Breakpoints window 204
    - Active icon 207
    - Breakpoint Properties button 206
    - Create Breakpoint Template button 205
    - Groups tab 206
    - Inactive icon 207
    - Instances tab 206
    - opening 207
    - Rename Breakpoint button 206
    - saving contents of 208
    - Set Default Breakpoint Template button 206
    - Templates tab 206
  - Breakpoints Window menu command 485
  - breakpoints, clearing 211
  - breakpoints, disabling 210
  - breakpoints, enabling 210, 223
  - breakpoints, setting 208
  - breakpoints, viewing properties for 209
  - Bring To Front menu command 485
  - Bring Up To Date 327
    - menu command 53, 54
  - Bring Up To Date menu command 421, 486
  - Browse button 123, 250, 296, 300, 308
  - Browse In Processes Window option 383, 384
  - browser 152
    - Class Browser window 155
    - Classes pane 161
    - collapsing panes 161
    - creating new classes 162, 175, 176
    - creating new data members 182
-

- 
- creating new member functions 179, 180, 181
    - expanding panes 160
    - hierarchy windows 168
    - Member Functions pane 163
    - overview 25
    - printing class hierarchies 169
    - purpose of 149
    - setting options 149
    - Source pane 164
    - status area 165
    - viewing data by contents 172
    - viewing data by inheritance 168
    - working with 149
  - Browser Access Filters 156
  - Browser Commands option 412
  - Browser Contents 156
  - Browser Contents command 486
  - Browser Contents window 171
    - Symbols list 171
  - browser database
    - defined 149
  - Browser menu 412
  - Browser Path option 412
  - Browser Wizard 175
  - Build Before Running option 412
  - Build Extras panel
    - options
      - Initial Directory field 424
      - Use External Debugger 441
      - Use modification date caching 442
  - Build Extras settings panel 255, 391
    - options
      - Application 393
      - Arguments 393
      - Cache Subprojects 392
      - Dump internal browse information after
        - compile 393
      - Initial directory 393
      - Use External Debugger 393
      - Use modification date caching 392
  - Build Extras target settings panel 494
  - build order 326
  - Build Progress menu command 486
  - Build Progress Window menu command 486
  - Build Settings panel
    - options
      - Play sound after ‘Bring Up To Date’ & ‘Make’ 428
      - Save open files before build 432
      - Show message after building up-to-date project 436
      - Success 439
      - Use Local Project Data Storage 442
  - Build Settings preference panel 353
    - options
      - Build before running 354
      - Compiler thread stack 354
      - Failure 354
      - Play sound after ‘Bring Up To Date’ & ‘Make’ 354
      - Save open files before build 354
      - Show message after building up-to-date project 354
      - Success 354
      - Use Local Project Data Storage 354
  - build system
    - overview 26
  - build targets 31
    - configuring 56
    - creating 55
    - management 50
    - managing 54
    - moving 52
    - removing 50, 55
    - renaming 53, 56
    - setting default 56
    - strategies for 40
  - Bus Noise checkbox 313
  - Bus Noise test
    - subtests
      - Full Range Converging 316
      - Maximum Invert Convergence 316
      - Sequential 316
  - bus noise, defined 316
  - Button
    - Delete 340
    - Export 348
-

- 
- Import 349
  - New Binding 347
  - Save 341
  - buttons
    - Access Target 310
    - Add 390
    - Add Default 409
    - Add Files 129
    - Apply 142
    - Begin Scope Loop 312
    - Begin Test 314
    - Blank Check 304
    - Breakpoint Properties 206
    - Breakpoints 190
    - Browse 123, 250, 296, 300, 308
    - Calculate Checksum 305
    - Cancel 116, 118
    - Change 390
    - Clear List 129
    - Compare 139
    - Create Breakpoint Template 205
    - Debug 189
    - Details 302, 303, 305, 310, 312, 314
    - Edit 374
    - Erase 304
    - Export Panel 418
    - Expressions 190
    - Factory Settings 421
    - Find 116, 118, 121
    - Find All 116, 121
    - Installed Products 483
    - Kill 189
    - Line and Column 192
    - Load Settings 294, 307
    - Next Result 132
    - OK 295, 307
    - Previous Result 132
    - Program 302
    - Purge Now 430
    - Read 251
    - Redo 143
    - Remove 390
    - Remove a Set 129
    - Rename Breakpoint 206
    - Replace 118, 121
    - Replace All 118, 121
    - Reset Value 252
    - resetting in toolbars 345
    - Resume 189
    - Revert 251
    - Run 189
    - Save Settings 295, 307
    - Save This Set 129
    - Set Default Breakpoint Template 206
    - Show Log 294, 314
    - Source File 191
    - Step Into 190
    - Step Out 190
    - Step Over 190
    - Stop 121, 131, 189
    - Symbolics 190
    - Unapply 142
    - Undo 142
    - Variables Pane Listing 191
    - Verify 302
    - Warnings 131
    - Write 251
  - By Type text/list box 123
  - Byte option button 309, 311, 313
- ## C
- cache
    - purging 430
  - Cache Edited Files Between Debug Sessions
    - option 413
  - Cache Subprojects option 413
  - Cache Symbolics Between Runs option 413
  - Cache window 318
    - opening 318
  - cached data 328
  - Calculate Checksum button 305
  - Can't Redo menu command 471
  - Can't Undo menu command 471
  - Cancel button 116, 118
  - Cancel button, in Remove Markers window 111
  - Cascade menu command 486
  - Case Sensitive checkbox 116, 118, 122, 138
  - Case Sensitive option 413
-

- 
- Change button 390
  - Change Program Counter menu command 486
  - changing
    - find strings 133
    - line views in a hierarchical window 169
    - register data views 248
    - register values 247
    - remote connections 383
    - source trees 364
  - character 450, 454, 457
  - Check Syntax command 486
  - Checkbox
    - Numeric Keypad Bindings 347
  - checkboxboxes
    - Address 313
    - All Sectors 303
    - Appears in Menus 133
    - Apply Address Offset 301
    - Bus Noise 313
    - Case sensitive 116, 118, 122, 138
    - Compare text file contents 139
    - Enable Logging 297
    - Erase Sectors Individually 303
    - Ignore extra space 139
    - Log Message 217
    - Match whole word 116, 118, 121
    - Only show different files 139
    - Project headers 125
    - Project sources 125
    - Regular expression 116, 118, 122
    - Restrict Address Range 301
    - Search cached sub-targets 125
    - Search selection only 116, 119
    - Search sub-folders 123
    - Search up 116, 119
    - Speak Message 217
    - Stop at end of file 116, 119
    - Stop in Debugger 217, 219, 221
    - System headers 125
    - Treat as Expression 217
    - Use Custom Settings 296, 308
    - Use Selected File 300
    - Use Target CPU 314
    - Use Target Initialization 296, 308
    - View Target Memory Writes 297
    - Walking 1's 313
  - Checkout Status column
    - in Files view of Project window 46
  - Checksum panel 304
  - child windows, defined 65
  - choosing
    - a default project 37
    - linkers 329
    - one character from many in regular expressions 136
  - class browser
    - purpose of windows 155
    - working with windows 155
  - Class Browser menu command 487
  - Class Browser window 155
    - Classes pane 157
    - Data Members pane 157
    - Member Functions pane 157
    - Status area 157
  - class data
    - viewing from hierarchy windows 160
  - Class Declaration 165
  - Class Hierarchy 156
  - Class Hierarchy menu command 487
  - Class Hierarchy Window menu command 487
  - class hierarchy windows
    - purpose of 167
    - working with 167
  - Class View 281, 282
  - classes
    - creating 162, 175, 176
    - hiding pane for 162
    - showing pane for 162
    - sorting list of 162
  - Classes option 374
  - Classes pane 161
    - in Class Browser window 157
  - classes.zip 484
  - Clear All Breakpoints menu command 487
  - Clear All Watchpoints menu command 487
  - Clear Breakpoint menu command 487
  - Clear Eventpoint menu command 487
-

- 
- Clear Floating Toolbar command in Toolbar submenu 487
  - Clear List button 129
  - Clear Main Toolbar menu command 488
  - Clear menu command 487
  - Clear Watchpoint menu command 488
  - Clear Window Toolbar command in Toolbar submenu 488
  - clearing
    - all breakpoints 211
    - all watchpoints 228
    - breakpoints 211
    - watchpoints 228
  - client area, defined 65
  - Clone Existing Target option 55
  - Close All command 63
  - Close All Editor Documents menu command 488
  - Close All menu command 488
  - Close Catalog menu command 488
  - Close command 38, 62
  - Close I/O console on process death option 414
  - Close menu command 488
  - Close Non-debugging Windows option 414
  - Close Workspace menu command 488
  - closing
    - all files 63
    - dockable windows 73
    - files 62
    - projects 38
    - workspaces 77
  - Code 400
  - code
    - adding markers to 111
    - completing 97
    - disabling breakpoints 210
    - disabling eventpoints 223
    - disabling special breakpoints 229
    - disabling watchpoints 227
    - enabling breakpoints 210, 223
    - enabling special breakpoints 230
    - enabling watchpoints 228
    - locating 107
    - navigating 107
    - object 325, 329
    - setting breakpoints in 208
    - setting watchpoints in 226
    - viewing breakpoint properties 209
    - viewing eventpoint properties 223
    - viewing watchpoint properties 227
  - Code column
    - in Files view of Project window 46
  - code completion
    - activating automatic behavior 98
    - configuration 98
    - deactivating automatic behavior 99
    - for data members 103
    - for parameter lists 104
    - navigating window 102
    - selecting items 103
    - triggering by keyboard 99
    - triggering from IDE menu bar 98
  - Code Completion Delay option 414
  - Code Completion preference panel 365
    - options
      - Automatic Invocation 366
      - Case sensitive 366
      - Code Completion Delay 366
      - Display deprecated items 366
      - Window follows insertion point 366
  - Code Completion window 100
  - code completion, triggering from IDE menu bar 98
  - Code Formatting preference panel 366
    - options
      - Close Braces, Brackets, And Parentheses 368
      - Format Braces 367
      - Indent Braces 368
      - Indent Case Within Switch Statement 368
      - Indent Code Within Braces 368
      - Language Settings 367
      - Place Else On Same Line As Closing Brace 368
      - Place Opening Brace On Separate Line 367
      - Use Automatic Code Formatting 367
  - Code Only option button 117, 119, 122
-

- 
- code resources 327
  - CodeWarrior
    - menu reference 469
    - overview 21
  - CodeWarrior Glossary command 489
  - CodeWarrior Help menu command 489
  - CodeWarrior IDE
    - Data menu 479
    - Debug menu 476
    - Edit menu 470
    - File menu 469
    - Help menu 481
    - Project menu 474
    - Search menu 473
    - Window menu 472, 481
  - CodeWarrior Website command 489
  - Collapse Non-debugging Windows option 414
  - Collapse Window menu command 489
  - collapsing
    - browser panes 161
    - dockable windows 72
  - collection method 273
  - COM 416
  - command
    - Make 330
    - Remove Object Code 328
    - Run 327
    - Run to Cursor 211
    - Synchronize Modification Dates 328
  - Command Actions
    - Arguments 337
    - Defining (Windows) 336
    - Directory 337
    - Execute 337
  - Command Group
    - Delete 340
  - Command Groups 340
    - Delete 340
  - Command window 320
    - issuing command lines 321
    - opening 320
  - command-line window 320
  - Commands
    - Import 348
    - Modify 335
  - commands 162
    - About Freescale CodeWarrior 483
    - Add Files 483
    - Add Window 483
    - Apply Difference 143, 484
    - Balance 485
    - Bottom Edges 485
    - Break 194, 485
    - Break On C++ Exception 485
    - Break on Java Exceptions 485
    - Breakpoints 485
    - Breakpoints Window 485
    - Bring To Front 485
    - Bring Up To Date 486
    - Browser Contents 156, 486
    - Build Progress 486
    - Build Progress Window 486
    - Can't Redo 471
    - Can't Undo 471
    - Cascade 486
    - Change Program Counter 486
    - Check Syntax 486
    - Class Browser 487
    - Class Declaration 165
    - Class Hierarchy 156, 487
    - Class Hierarchy Window 487
    - Clear 487
    - Clear All Breakpoints 487
    - Clear All Watchpoints 487
    - Clear Breakpoint 487
    - Clear Eventpoint 487
    - Clear Main Toolbar 488
    - Clear Watchpoint 488
    - Close 38, 488
    - Close All 488
    - Close All Editor Documents 488
    - Close Catalog 488
    - Close Workspace 488
    - CodeWarrior Glossary 489
    - CodeWarrior Help 489
    - CodeWarrior Website 489
    - Collapse Window 489
    - Commands & Key Bindings 489
-

- 
- Compare Files 139, 489
  - Compile 490
  - Complete Code 489
  - Connect 490
  - Copy 490
  - Copy To Expression 490
  - Create Design 490
  - Create Group 490
  - Create Target 491
  - Cut 491
  - Cycle View 491
  - Debug 192, 491
  - Delete 503
  - Diagonal Line 169
  - Disable Breakpoint 492
  - Disable Watchpoint 492
  - Disassemble 492
  - Display Grid 492
  - Enable Breakpoint 492
  - Enable Watchpoint 492
  - Enter Find String 133, 493
  - Enter Replace String 493
  - Errors And Warnings 493
  - Errors And Warnings Window 493
  - Exit 493
  - Expand Window 493
  - Export Project 37, 494, 498
  - Expressions 494
  - Expressions Window 494
  - File Path 47
  - Find 117, 494
  - Find and Open 'Filename' 495
  - Find and Open File 495
  - Find And Replace 496
  - Find Definition 494
  - Find Definition & Reference 113, 494
  - Find In Files 495
  - Find In Next File 495
  - Find In Previous File 495
  - Find Next 132, 495
  - Find Previous 133, 495
  - Find Previous Selection 495
  - Find Reference 113, 496
  - Find Selection 134, 496
  - Get Next Completion 496
  - Get Previous Completion 496
  - Global Variables 496
  - Global Variables Window 496
  - Go Back 156, 497
  - Go Forward 156, 497
  - Go To Line 497
  - Hide Breakpoints 497
  - Hide Classes 162
  - Hide Classes pane 165
  - Hide Window Toolbar 497
  - Import Components 498
  - Import Project 37, 498
  - Insert Reference Template 498
  - Kill 194, 498
  - Make 499
  - Maximize Window 499
  - Minimize Window 499
  - New 499
  - New Class 499
  - New Class Browser 499
  - New Data 499
  - New Event 500
  - New Event Set 500
  - New Expression 500
  - New Item 161
  - New Member Function 500
  - New Method 500
  - New Property 500
  - New Text File 500
  - Open 501
  - Open File 165
  - Open In Windows Explorer 47
  - Open Recent 501
  - Open Scripts Folder 501
  - Open Workspace 501
  - Page Setup 501
  - Pane Collapse 161
  - Pane Expand 160
  - Precompile 502
  - Preferences 502
  - Print 502
  - Processes 502
  - Processes Window 502

- 
- Project Inspector 36
  - Redo 503
  - Refresh All Data 503
  - Register Details Window 249, 503
  - Register Windows 503
  - Registers 503
  - Remove Object Code 504
  - Remove Object Code & Compact 504
  - Remove Toolbar Item 344
  - Replace 119, 504, 505
  - Replace All 504
  - Replace and Find Next 504
  - Restart 195
  - Resume 194, 506
  - Revert 507
  - Run 194, 429, 507
  - Run To Cursor 507
  - Save Default Window 508
  - Save Workspace 508
  - Save Workspace As 508
  - Select All 508
  - Send To Back 508
  - Set Breakpoint 508
  - Set Default Project 37, 509
  - Set Default Target 509
  - Set Eventpoint 509
  - Set Watchpoint 509
  - Shift Right 509
  - Show Breakpoints 487, 510
  - Show Classes 162
  - Show Classes pane 165
  - Show Inherited 157
  - Show private 158
  - Show protected 158
  - Show public 158
  - Show Types 510
  - Show Window Toolbar 497
  - Single Class Hierarchy Window 156
  - Sort Alphabetical 161, 162
  - Sort Hierarchical 161
  - Stack Editor Windows 510
  - Step Into 193
  - Step Out 193
  - Step Over 193, 510
  - Stop 194
  - Stop Build 511
  - Straight Line 169
  - Switch To Monitor 511
  - Symbolics 511
  - Symbolics Window 511
  - Synchronize Modification Dates 511
  - Unapply Difference 143
  - View Array 515
  - View as implementor 158
  - View as subclass 158
  - View As Unsigned Decimal 515, 516, 517
  - View as user 158
  - View Disassembly 517
  - View Mixed 517
  - View Source 518
  - View Variable 518
  - Zoom Window 518
  - Commands & Key Bindings menu command 489
  - Commands tab 333, 335, 346
  - Commands&KeyBindings.mkb file 348
  - Comments Only option button 117, 119, 122
  - Comments option 414
  - common debugging actions 192
  - Common Subexpression Elimination 399
  - Compact Targets 328
  - Compare button 139
  - Compare Files command 139
  - Compare Files menu command 489
  - Compare Files Setup window 138
    - Case Sensitive checkbox 138
    - Compare button 139
    - Compare Text File Contents checkbox 139
    - Destination box 138
    - Ignore Extra Space checkbox 139
    - Only Show Different Files checkbox 139
    - Source box 138
  - Compare Text File Contents checkbox 139
  - comparing files
    - differences, applying 143
    - differences, unapplying 143
    - overview 137
    - setup 138, 139
  - comparing files, explained 141



- 
- comparing folders
    - examining results 146
    - overview 137
    - setup 138, 140
  - comparing folders, explained 144
  - comparison
    - destination item 137
    - source item 137
  - Compile menu command 490
  - compiler
    - avoiding crashes 415
  - compiler directives 272, 285
  - Compiler option 414
  - Compiler option, in Generate Browser Data From menu 423
  - compiler thread stack
    - and avoiding compiler crashes 415
  - Compiler Thread Stack field 415
  - compiling projects 325
  - Complete Code menu command 489
  - completing code 97
  - Component Object Model. *See* COM.
  - Concurrent Compiles panel
    - options
      - Use Concurrent Compiles 430, 441
      - User Specified 445
  - Concurrent Compiles preference panel 355
    - options
      - Recommended 355
      - Use Concurrent Compiles 355
      - User Specified 355
  - CONDITION 455
  - condition, breakpoint property 209
  - conditional access breakpoint 228
  - conditional breakpoint, defined 211
  - conditional breakpoints 204
    - setting 211
  - conditional eventpoint, defined 224
  - conditional eventpoints
    - setting 224
  - conditional watchpoint, defined 228
  - conditional watchpoints
    - setting 228
  - Configuration panel 307
  - configuring
    - build targets 56
    - code completion 98
    - targets 56
  - Confirm “Kill Process” When Closing Or Quitting option 415
  - Confirm Invalid File Modification Dates When Debugging option 415
  - Connect menu command 490
  - Connection list box 296, 308
  - Connection Type option 383, 384
  - console applications
    - creating 79
  - console applications, about 79
  - constant
    - adding to a variable 237
  - Constants option 374
  - contents
    - of register 249
  - Context Popup Delay option 415
  - contextual menus 196
    - File Path command 47
    - Open In Windows Explorer command 47
    - using 197
    - using to dock a window 68
  - controlling program execution 187
  - conventions
    - figures 19
    - for manual 19
    - keyboard shortcuts 19
  - Copy And Expression Propagation 399
  - Copy menu command 490
  - Copy Propagation 399
  - Copy To Expression command 490
  - cores, debugging multiple 197
  - Create Breakpoint Template button 205
  - Create Design menu command 490
  - Create Group menu command 490
  - Create Target command 55
  - Create Target menu command 491
  - creating
    - a new data member 164
    - build targets 55
    - console applications 79
-

- 
- custom project stationery 38
    - empty projects 34
    - files (Macintosh) 60
    - files (Windows) 59
    - member functions 163
    - new classes 162, 175, 176
    - new data member 181
    - new data members 182
    - new member function 179
    - new member functions 180
    - projects from makefiles 33
    - projects using stationery 33
    - subprojects 39
    - targets 55
  - cross-platform migration, and opening
    - projects 35
  - Current Target 328
  - Current Target list pop-up 44
  - Current Target menu 344
  - current-statement arrow 191
  - custom project stationery 38
  - Customize IDE Commands window 133, 333, 346, 347
    - Action 335
    - Appears in Menus 335, 336
    - Appears in Menus checkbox 133
    - Auto Repeat 335
    - Key Bindings 335
    - Name field 335
    - New Binding 335
    - New Group 335
    - Numeric Keypad Bindings checkbox 350
  - Cut command 491
  - CVS 362
  - Cycle View menu command 491
- D**
- dash 191
  - data
    - browser 328
    - cached 328
    - dependency 328
    - finding problems 282
    - sorting 280
    - target 328
  - Data column
    - in Files view of Project window 46
  - data columns
    - contents 279
  - Data Line fault 315
  - data members
    - completing code 103
    - creating 164, 182
    - identifier icons 163
  - Data Members pane 164
    - in Class Browser window 157
  - Data menu 479
  - Data Viewers Plugins 198
  - Data Visualization Plugins 198
  - data, for debugger, working with 255
  - database
    - navigation for browser 152
  - dates
    - modification 328
    - synchronizing 328
  - deactivating automatic code completion 99
  - Dead Code Elimination 399
  - Dead Store Elimination 399
  - Debug button 189
  - Debug column
    - in Files view of Project window 46
  - Debug command 53, 54, 192
  - Debug menu 416, 476
    - Clear All Breakpoints command 478
    - Disable Watchpoint command 477, 478
    - Enable Breakpoint command 477
    - Enable Watchpoint command 477, 478
    - Hide Breakpoints command 478
  - Debug menu command 491
  - debugger 430
    - attaching to a process 260
    - choosing for an opened symbolics file 383
    - overview 26
    - restarting 195
    - starting 192
    - working with data 255
    - working with memory 239
    - working with variables 231
-

- 
- Debugger Commands option 416
  - Debugger section, of IDE preference panels 376
  - Debugger Settings panel 260, 405
    - options
      - Auto-target Libraries 406
      - Cache symbolics between runs 406
      - Default language entry point 406, 416
      - Location of Relocated Libraries and Code Resources 406, 427
      - Log System Messages 406, 427
      - Program entry point 429
      - Stop at Watchpoints 406, 437
      - Stop on application launch 406, 437
      - Update data every  $n$  seconds 441
      - Update data every  $n$  seconds 406
      - User specified 406
  - debugger, defined 187
  - debugging
    - common actions 192
    - multiple cores 197
    - program execution 187
    - restarting a session 195
    - starting a session 192
  - decimal 450, 454, 457
  - Declaration File field 177
  - default breakpoint template 213
  - Default File Format option 416
  - default filename extensions 419
  - Default Language Entry Point option
    - Debugger Settings panel 416
  - Default Project 296, 307
  - default projects 37
  - default size and position of windows, setting 508
  - Default Size For Unbounded Arrays option 416
  - Default Target 296, 307
  - default target, setting 56
  - default workspace
    - definition of 75
    - using 76
  - definition
    - of breakpoint template 204
    - of breakpoints 203
    - of bus noise 316
    - of child windows 65
    - of client area 65
    - of conditional breakpoint 211
    - of conditional eventpoint 224
    - of conditional watchpoint 228
    - of debugger 187
    - of default workspace 75
    - of dock 65
    - of eventpoints 215
    - of machines 258
    - of memory aliasing 315
    - of non-modal 67
    - of project 29
    - of regular expression 134
    - of special breakpoints 229
    - of symbolics file 188
    - of symbols 112
    - of temporary breakpoint 211
    - of touch 46
    - of watchpoints 225
    - of workspace 75
  - Delete menu command 503
  - dependency information 328
  - DESCRIPTION 452, 456, 457
  - Description 251
  - Description File text box 250, 252
  - Design view 52
  - Designs view 36
  - desktop background
    - removing from behind IDE. *See* Use Multiple Document Interface, turning on.
    - seeing behind IDE. *See* Use Multiple Document Interface, turning off.
  - Destination box 138
  - destination item, for comparison 137
  - Destination pane 142
  - Detail View 280
  - detail view 280
  - detailed data, collecting 273
  - details
    - viewing for registers 249
  - Details button 302, 303, 305, 310, 312, 314
  - development-process cycle for software 21
  - Device pane 298
  - diagnostics
-

- 
- disabling for plug-ins 483
    - enabling for plug-ins 483
  - Diagonal Line 169
  - dialog boxes
    - New Connection 382
  - difference from Single-Class Hierarchy window 170
  - Differences pane 143
  - directives
    - C/C++ 285
    - compiler 272
  - Disable Breakpoint menu command 492
  - Disable Third Party COM Plugins option 416
  - Disable Watchpoint menu command 492
  - disabled breakpoint 204, 225
  - disabled eventpoint 216
  - disabling
    - plug-in diagnostics 483
  - Disassemble menu command 492
  - disclosure triangles
    - Source Code pane 132
    - Source pane 191
  - Display Deprecated Items option 416
  - Display Grid menu command 492
  - Display Settings panel 227
    - options
      - Show all locals 433
      - Show tasks in separate windows 436
      - Show values as decimal instead of hex 436
      - Show variable location 436
      - Show variable types 436
      - Show variable values in source code 437
      - Sort functions by method name in symbolics window 437
      - Variable Values Change 445
      - Watchpoint Indicator 446
  - Display Settings preference panel 376
    - options
      - Attempt to use dynamic type of C++, Object Pascal and SOM objects 378
      - Default size for unbounded arrays 378
      - Show all locals 377
      - Show tasks in separate windows 379
      - Show values as decimal instead of hex 378
      - Show variable location 377
      - Show variable types 377
      - Show variable values in source code 378
      - Sort functions by method name in symbolics window 378
      - Variable values change 377
      - Watchpoint indicator 377
  - DLL 381, 410
  - DLLs 327
  - Do Nothing To Project Windows option 417
  - dock bars 72
  - dock, defined 65
  - dockable windows 65, 68
    - about 65
    - closing 73
    - collapsing 72
    - dock bars 72
    - docking windows of the same kind 69
    - expanding 73
    - moving 73
    - suppressing 72
    - turning off 72
    - types 66
  - Document Settings list pop-up 89
  - document settings pop-up using 89
  - documentation
    - formats 18
    - structure 18
    - types 18
  - Documents option
    - IDE Extras panel 417
  - Don't Step Into Runtime Support Code 417
  - Don't Step Into Runtime Support Code option 417
  - Done button, in Remove Markers window 111
  - drag and drop
    - using to dock a window 69
  - Drag And Drop Editing option 417
-

---

Dump Internal Browse Information After  
 Compile option 417  
 dump memory 517

## E

Edit button 374  
 Edit Commands option 417  
 Edit Language option 418  
 Edit menu 417, 470  
 editing  
   source code 93  
   symbols, shortcuts for 96  
 editor 85  
   overview 25  
   third-party support 444  
 Editor section, of IDE preference panels 365  
 Editor Settings panel  
   options  
     Balance Flash Delay 412  
     Font Preferences 422  
     Left margin click selects line 426  
     Project Commands 429  
     Relaxed C popup parsing 430  
     Selection position 433  
     Sort function popup 439  
     Use "not found" dialog 443  
     Use multiple undo 443  
     VCS Commands 445  
     Window position and size 446  
 Editor Settings preference panel 368  
   options  
     Balance Flash Delay 370  
     Balance while typing 370  
     Browser Commands 369  
     Debugger Commands 370  
     Default file format 370  
     Drag and drop editing 370  
     Edit Commands 369  
     Enable Virtual Space 370  
     Font preferences 369  
     Left margin click selects line 370  
     Project Commands 369  
     Relaxed C popup parsing 370  
     Selection position 369

Sort function popup 370  
 Use "not found" dialog 370  
 Use multiple undo 370  
 VCS Commands 369  
 Window position and size 369  
 editor toolbar 88  
 editor window 85  
   adding panes to 91  
   Breakpoints column 90  
   collapsing toolbar in 88  
   expanding toolbar in 88  
   line and column indicator 91  
   pane splitter controls 91  
   removing panes from 91  
   resizing panes 91  
   text editing area 90  
 editor windows  
   other 90  
   selecting text in 93  
 element  
   BFVALUE 456  
   BITFIELD 453, 456  
   REGISTER 451  
 Emacs text editor 425  
 empty projects  
   creating 34  
 Empty Target option 55  
 Enable Automatic Toolbar Help option 418  
 Enable Breakpoint menu command 492  
 Enable Browser option 486  
 Enable Logging checkbox 297  
 Enable Remote Debugging option 418  
 Enable Virtual Space option 418  
 Enable Watchpoint menu command 492  
 enabled breakpoint 204  
 enabled eventpoint 216  
 enabled watchpoint 225  
 enabling  
   plug-in diagnostics 483  
 End text box 301, 313  
 end-of-line format 416  
 enlarging panes, in browser 160  
 Enter Find String command 133  
 Enter Find String menu command 493

- 
- Enter Replace String menu command 493
  - Entire Flash option button 305
  - Enums option 374
  - Environment Settings option 418
  - Environment Variable option
    - of Source Trees preference panel 441
  - Environment Variable option, in Type pop-up menu 441
  - EOL format 416
  - Erase / Blank Check panel 302
  - Erase button 304
  - Erase Sectors Individually checkbox 303
  - errors
    - syntax 325
  - Errors And Warnings menu command 493
  - Errors And Warnings Window menu command 493
  - Errors Only option
    - of Plugin Diagnostics 426
  - eventpoints
    - defined 215
    - disabled 216
    - enabled 216
    - Log Point 215, 216
    - Log Point, clearing 217
    - Log Point, setting 216
    - Pause Point 215, 218
    - Pause Point, clearing 218
    - Pause Point, setting 218
    - purpose of 203
    - Script Point 215, 218
    - Script Point, clearing 219
    - Script Point, setting 219
    - setting conditional 224
    - Skip Point 215, 220
    - Skip Point, clearing 220
    - Skip Point, setting 220
    - Sound Point 215, 220
    - Sound Point, clearing 221
    - Sound Point, setting 220
    - Sound Point, Speak Message 220
    - Trace Collection Off 216, 221
    - Trace Collection Off, clearing 222
    - Trace Collection Off, setting 221
    - Trace Collection On 216, 222
    - Trace Collection On, clearing 222
    - Trace Collection On, setting 222
    - working with 223
  - eventpoints, disabling 223
  - eventpoints, viewing properties for 223
  - examining debugger data 255
  - examining memory 239
  - examining variables 231
  - exceptions 275
  - Exceptions In Targeted Classes command in Java
    - Exceptions submenu 493
  - executable files
    - adding to the Other Executables list 403
    - changing in the Other Executables list 404
    - removing from the Other Executables list 405
  - execution
    - of program, controlling 187
  - execution, killing 194
  - execution, resuming 194
  - execution, stopping 194
  - Exit menu command 493
  - exit() 276
  - exit() 276
  - Expand Window menu command 493
  - expanding
    - browser panes 160
    - dockable windows 73
  - Export 348
  - Export Panel button 334, 352, 418
  - Export Project command 37
  - Export Project menu command 494, 498
  - exporting
    - projects to XML files 37
  - expression 455
  - Expression Simplification 399
  - Expressions button 190
  - Expressions menu command 494
  - Expressions window 235
    - adding expressions 236
    - opening 236
  - Expressions Window menu command 494
  - Extension field 419
-

external editor support 444

## F

Factory Settings button 421

Failure option 421

FDI 357, 443

and dockable windows 65

fields

Application 410

Arguments 410

Base Classes 178

Compiler thread stack 415

Declaration File 177

Extension 419

File Type 421

IP Address 383

Relative to class 177

figure conventions 19

File

Commands&KeyBindings.mkb 348

file

binary 329

map 330

non-executable 327

File column

in Files view of Project window 46

`%file` command-line string 425

File Compare Results window 141

Apply button 142

Destination pane 142

Differences pane 143

pane resize bar 142

Redo button 143

Source pane 142

Unapply button 142

Undo button 142

file extension

.MAP 330

.tdt 328

xMAP 330

File list 125

file management 50

File Mappings list 414

File Mappings settings panel 325, 395

options

Add 397

Change 397

Compiler 396

Edit Language 397

Extension 396

File Mappings list 396

File Type 396

Flags 396

Ignored By Make flag 396

Launchable flag 396

Precompiled File flag 396

Remove 397

Resource File flag 396

File menu 469

file modification icon 90

File On Host option button 305

File On Target option button 305

File Path command 47

file paths

viewing 47

File Set list 129

File Set list box 129

File Type field 421

File Type option 414

file-info, breakpoint property 209

filename extensions

default settings 419

files

close all 63

closing 62

comparing 141

creating (Macintosh) 60

creating (Windows) 59

destination (for a comparison) 137

inspecting 36

moving 52

opening 60

print selections 63

printing 63

renaming 52

replacing text in 119

reverting 64

save all 61

- 
- saving 61
  - saving copies 62
  - searching (multiple) 129
  - searching (single) 117
  - source (for a comparison) 137
  - target data 328
  - touching 53
  - touching all 53
  - untouching 54
  - untouching all 54
  - working with 59
  - Files In Both Folders pane 145
  - Files Only In Destination pane 146
  - Files Only In Source pane 145
  - Files page, about 45
  - Files tab 50
  - Files view 36, 52, 54
    - Checkout Status column 46
    - Code column 46
    - Data column 46
    - Debug column 46
    - File column 46
    - Interfaces list pop-up 46
    - Sort Order button 46
    - Target column 46
    - Touch column 46
  - files, tasks for managing 59
  - Find
    - by text selection 132
    - single-file 115
  - Find All button 116, 121
  - Find and compare operations option
    - Shielded Folders panel 421
  - Find And Open 'Filename' menu command 495
  - Find and Open File command 495
  - Find and Replace
    - multiple-file 120
    - single-file 117
  - Find And Replace menu command 496
  - Find and Replace window
    - All Text option button 119
    - Cancel button 118
    - Case Sensitive checkbox 118
    - Code Only option button 119
    - Comments Only option button 119
    - Find button 118
    - Find text/list box 118
    - Match Whole Word checkbox 118
    - Regular Expression checkbox 118
    - Replace All button 118
    - Replace button 118
    - Replace With text/list box 118
    - Search Selection Only checkbox 119
    - Search Up checkbox 119
    - Stop At End Of File checkbox 119
  - Find button 116, 118, 121
  - Find command 117, 494
  - Find Definition & Reference command 113
  - Find Definition & Reference menu command 494
  - Find Definition menu command 494
  - Find In Files menu command 495
  - Find in Files window
    - All Text option button 122
    - Case Sensitive checkbox 122
    - Code Only option button 122
    - Comments Only option button 122
    - Find All button 121
    - Find button 121
    - Find text/list box 121
    - In Files page 128, 129
      - Add Files button 129
      - Clear List button 129
      - File Set list 129
      - File Set list box 129
      - Remove A Set button 129
      - Save This Set button 129
    - In Files tab 122
    - In Folders page 122, 123
      - Browse button 123
      - By Type text/list box 123
      - Search In text/list box 123
      - Search Sub-Folders checkbox 123
    - In Folders tab 122
    - In Projects page 124, 125
      - File list 125
      - Project Headers checkbox 125
      - Project list box 125
      - Project Sources checkbox 125
-



- 
- Search Cached Sub-Targets
      - checkbox 125
    - System Headers checkbox 125
    - Target list box 125
  - In Projects tab 122
  - In Symbolics page 126, 127
    - Symbolics list 127
    - Symbolics list box 127
  - In Symbolics tab 122
  - Match Whole Word checkbox 121
  - Regular Expression checkbox 122
  - Replace All button 121
  - Replace button 121
  - Replace With text/list box 121
  - Stop button 121
- Find In Next File menu command 495
  - Find In Previous File menu command 495
  - Find Next
    - using 132
  - Find Next command 132
  - Find Next menu command 495
  - Find Previous
    - using 133
  - Find Previous command 133
    - enabling in the Customize IDE Commands window 133
  - Find Previous menu command 495
  - Find Previous Selection menu command 495
  - Find Reference command 113
  - Find Reference menu command 496
  - Find Reference using option
    - IDE Extras panel 421
  - Find Selection command 134
  - Find Selection menu command 496
  - Find symbols with prefix 96
  - Find symbols with substring 96
  - Find text/list box 116, 118, 121
  - Find window
    - All Text option button 116
    - Cancel button 116
    - Case Sensitive checkbox 116
    - Code Only option button 117
    - Comments Only option button 117
    - Find All button 116
    - Find button 116
    - Find text/list box 116
    - Match Whole Word checkbox 116
    - Regular Expression checkbox 116
    - Search Selection Only checkbox 116
    - Search Up checkbox 116
    - Stop At End Of File checkbox 116
  - finding problems 282
  - finding text
    - overview 115
  - Flags pop-up menu 396
    - Ignored By Make flag 396
    - Launchable flag 396
    - Precompiled File flag 396
    - Resource File flag 396
  - Flash Base + Offset 301
  - Flash Base Address 301
  - Flash Configuration panel 297
  - Flash Memory Base Address text box 298
  - Flash Programmer pane 294
  - flash programmer panels
    - Checksum 304
    - Erase / Blank Check 302
    - Flash Configuration 297
    - Program / Verify 299
    - Target Configuration 295
  - Flash Programmer window 293
    - Checksum panel
      - Calculate Checksum button 305
      - Details button 305
      - Entire Flash option button 305
      - File On Host option button 305
      - File On Target option button 305
      - Memory Range On Target option button 305
      - Size text box 305
      - Start text box 305
      - Status 305
    - Erase / Blank Check panel
      - All Sectors checkbox 303
      - All Sectors list 303
      - Blank Check button 304
      - Details button 303
      - Erase button 304

- 
- Erase Sectors individually
    - checkbox 303
    - Status 303
  - Flash Configuration panel
    - Device pane 298
    - Flash Memory Base Address text box 298
    - Organization pane 299
    - Sector Address Map pane 299
  - Flash Programmer pane 294
  - Load Settings button 294
  - OK button 295
  - opening 293
  - Program / Verify panel
    - Apply Address Offset checkbox 301
    - Browse button 300
    - Details button 302
    - End text box 301
    - Flash Base + Offset 301
    - Flash Base Address 301
    - Offset text box 301
    - Program button 302
    - Restrict Address Range checkbox 301
    - Start text box 301
    - Status 302
    - Use Selected File checkbox 300
    - Use Selected File text box 300
    - Verify button 302
  - Save Settings button 295
  - Show Log button 294
  - Target Configuration panel
    - Browse button 296
    - Connection list box 296
    - Default Project 296
    - Default Target 296
    - Enable Logging checkbox 297
    - Processor Family list box 296
    - Target Memory Buffer Address text box 296
    - Target Memory Buffer Size text box 297
    - Target Processor text/list box 296
    - Use Custom Settings checkbox 296
    - Use Target Initialization checkbox 296
    - Use Target Initialization text box 296
    - View Target Memory Writes checkbox 297
  - Flat View 280
  - floating a window 71
  - Floating Document Interface. *See* FDI.
  - floating window type 66
  - focus bar 52
  - folder
    - Registers 457
  - Folder Compare Results window 144
    - Files In Both Folders pane 145
    - Files Only In Destination pane 146
    - Files Only In Source pane 145
    - Pane Collapse box 145
    - Pane Expand box 145
    - pane resize bar 145
    - Selected Item group 146
  - folders
    - comparing 144
    - Registers 249
    - searching (multiple) 123
  - Font & Tabs panel 372
    - options
      - Font 422
      - Scripts 433
      - Size 437
      - Tab indents selection 440
      - Tab Inserts Spaces 440
      - Tab Size 440
  - Font & Tabs preference panel 370, 373
    - options
      - Auto Indent 372
      - Font 371
      - Script 371
      - Size 371
      - Tab indents selection 371
      - Tab Inserts Spaces 372
      - Tab Size 371
  - Font option
    - Font & Tabs panel 422
  - Font Preferences option
    - Editor Settings panel 422
  - Font Settings 372
-

- 
- Foreground option
    - Text Colors panel 422
  - FORMAT 454
  - format 450, 454, 457
    - binary 450, 454, 457
    - character 450, 454, 457
    - decimal 450, 454, 457
    - hexadecimal 450, 454, 457
    - octal 450, 454, 457
  - Format list box 250
  - format, for end of line (EOL) 416
  - formats
    - for documentation 18
  - FPU Registers 246
  - frames text box
    - Global Settings panel 422
  - Full Range Converging substest 316
  - function
    - exit() 276
    - New Data Member 164
    - ProfilerTerm() 276
  - function-level profiling 269, 285
  - functions
    - creating new member 163
    - locating 107, 108
    - ProfilerInit() 290, 291
  - Functions list box 191
  - Functions list pop-up 88
    - sorting alphabetically 108, 109
    - using 108
  - Functions option 374
- G**
- General Registers 246
  - General section, of IDE preference panels 353
  - Generate Browser Data From option 422
    - Compiler 423
    - Language Parser 423
    - Language Parser, Macro file 423
    - Language Parser, Prefix file 423
    - None 422
  - Generate Constructor and Destructor 178
  - Generate Link Map 330
  - Get Next Completion menu command 496
  - Get next symbol 96
  - Get Previous Completion menu command 496
  - Get previous symbol 96
  - Global Optimizations settings panel 397
    - options
      - Details 398
      - Faster Execution Speed 398
      - Optimization Level slider 398
      - Smaller Code Size 398
  - Global Register Allocation 399
  - Global Register Allocation Only For Temporary Values 399
  - Global Settings panel
    - options
      - Close I/O console on process death 414
      - frames 422
      - Limit Stack Crawls 426
      - Purge after 430
      - Reopen I/O console as needed 431
      - Select thread window when stopping task 433
    - Re-execute target init script even if already connected 430
  - Global Settings preference panel
    - options
      - Auto Target Libraries 381
      - Automatically launch applications when SYM file opened 380
      - Cache Edited Files Between Debug Sessions 380
      - Close I/O console on process death 381
      - Confirm "Kill Process" when closing or quitting 381
      - Confirm invalid file modification dates when debugging 380
      - Don't step into runtime support code 381
      - frames 380
      - Limit Stack Crawls 380
      - Purge after 380
      - Purge Now 380
      - Re-execute target init script even if already connected 381
      - Reopen I/O console as needed 381
-

- 
- Select thread window when stopping task 381
  - Global Variables menu command 496
  - Global Variables window 231
    - opening 232
    - viewing for different processes 232
  - Global Variables Window menu command 496
  - Globals option 374
  - Go Back 156
  - Go Back menu command 497
  - Go Forward 156
  - Go Forward menu command 497
  - Go To Line menu command 497
  - going back 109
  - going forward 109
  - going to a particular line 109
  - gray background, adding behind IDE. *See* Use Multiple Document Interface, turning on.
  - gray background, removing from behind IDE. *See* Use Multiple Document Interface, turning off.
  - Grid Size X option
    - Layout Editor panel 423
  - Grid Size Y option
    - Layout Editor panel 423
  - group management 50
  - grouping
    - regular expressions 136
  - groups
    - moving 52
    - removing 50
    - renaming 52
    - Selected Item 146
    - touching 53
    - touching all 53
    - untouching 54
    - untouching all 54
  - Groups tab 206
- H**
- hardware diagnostic panels
    - Configuration 307
    - Memory Read / Write 308
    - Memory Tests 312
      - Address 315
      - Bus Noise 316
      - Bus Noise in address lines 316
      - Bus Noise in data lines 317
      - Walking Ones 314
    - Scope Loop 310
  - Hardware Diagnostics pane 306
  - Hardware Diagnostics window 306
    - Configuration panel
      - Browse button 308
      - Connection list box 308
      - Default Project 307
      - Default Target 307
      - Processor Family list box 308
      - Target Processor text/list box 308
      - Use Custom Settings checkbox 308
      - Use Target Initialization checkbox 308
      - Use Target Initialization text box 308
  - Hardware Diagnostics pane 306
  - Load Settings button 307
  - Memory Read / Write panel
    - Access Target button 310
    - Byte option button 309
    - Details button 310
    - Long Word option button 309
    - Read option button 309
    - Status 310
    - Target Address text box 309
    - Value to write text box 309
    - Word option button 309
    - Write option button 309
  - Memory Tests panel
    - Address checkbox 313
    - Begin Test button 314
    - Bus Noise checkbox 313
    - Byte option button 313
    - Details button 314
    - End text box 313
    - Long Word option button 314
    - Passes text box 314
    - Show Log button 314
    - Start text box 313
    - Status 314
    - Target Scratch Memory End text box 314
-

- 
- Target Scratch Memory Start text box 314
    - Use Target CPU checkbox 314
    - Walking 1's checkbox 313
    - Word option button 314
  - OK button 307
  - opening 306
  - Save Settings button 307
  - Scope Loop panel
    - Begin Scope Loop button 312
    - Byte option button 311
    - Details button 312
    - Long Word option button 311
    - Read option button 311
    - Speed slider 311
    - Status 312
    - Target Address text box 311
    - Value to write text box 311
    - Word option button 311
    - Write option button 311
  - hardware tools, working with 293
  - heap 286
  - Help menu 481
  - Help Preferences panel 358
    - options
      - Browser Path 359
      - Set 359
  - hexadecimal 450, 454, 457
  - Hide Breakpoints menu command 497
  - Hide Classes 162
  - Hide Classes pane 165
  - Hide Floating Toolbar command 497
  - Hide Main Toolbar command in Toolbar submenu 497
  - Hide non-debugging windows option
    - Windowing panel 423
  - Hide Window Toolbar command 497
  - hiding
    - classes pane 162
  - Hierarchy Control 168
  - hierarchy window 168
  - hierarchy windows
    - changing line views 169
    - using to view class data 160
  - hit count, breakpoint property 209
  - Horizontal Center command 498
  - Host Application for Libraries & Code Resources option
    - Runtime Settings panel 423
  - Host Application For Libraries And Code Resources field
    - of Runtime Settings panel 423
  - host-specific registers 246
  - how to
    - activate automatic code completion 98
    - add a constant to a variable 237
    - add a keyword to a keyword set 401
    - add an executable file 403
    - add expressions (Expressions window) 236
    - add markers to a source file 111
    - add panes to an editor window 91
    - add remote connections 382
    - add source trees 363
    - adding subprojects to a project 39
    - alphabetize Functions list pop-up order 108, 109
    - apply file differences 143
    - attach the debugger to a process 260
    - balance punctuation 96
    - change an executable file 404
    - change line views in a hierarchical window 169
    - change register data views 248
    - change register values 247
    - change remote connections 383
    - change source trees 364
    - change the find string 133
    - choose a default project 37
    - choose files to compare 139
    - choose folders to compare 140
    - clear a breakpoint 211
    - clear a Log Point 217
    - clear a Pause Point 218
    - clear a Script Point 219
    - clear a Skip Point 220
    - clear a Sound Point 221
    - clear a Trace Collection Off eventpoint 222
    - clear a Trace Collection On eventpoint 222
-

- 
- clear a watchpoint 228
  - clear all breakpoints 211
  - clear all watchpoints 228
  - close a docked window 73
  - close a workspace 77
  - close projects 38
  - collapse a docked window 72
  - collapse browser panes 161
  - collapse the editor window toolbar 88
  - complete code for data members 103
  - complete code for parameter lists 104
  - create a breakpoint template 213
  - create a new class 162, 175, 176
  - create a new data member 181, 182
  - create a new data members 164
  - create a new member function 163, 179, 180
  - create custom project stationery 38
  - create empty projects 34
  - create new projects from makefiles 33
  - create new projects using project stationery 33
  - deactivate automatic code completion 99
  - delete a breakpoint template 214
  - disable a breakpoint 210
  - disable a watchpoint 227
  - disable an eventpoint 223
  - dock a window by using a contextual menu 68
  - dock a window by using drag and drop 69
  - dock windows of the same kind 69
  - enable a breakpoint 210, 223
  - enable a watchpoint 228
  - examine items in the Folder Compare Results window 146
  - expand a docked window 73
  - expand browser panes 160
  - expand the editor window toolbar 88
  - export projects to XML files 37
  - float a window 71
  - generate project link maps 330
  - go to a particular line 109
  - hide the classes pane 162
  - import projects saved as XML files 37
  - indent text blocks 95
  - issue command lines 321
  - kill program execution 194
  - look up symbol definitions 112
  - make a summation of two variables 237
  - make a window an MDI Child 71
  - manipulate variable formats 234
  - move a docked window 73
  - navigate browser data 152
  - navigate Code Completion window 102
  - navigate to a marker 111
  - open a recent workspace 77
  - open a single-class hierarchical window 170
  - open a workspace 77
  - open an Array window 245
  - open projects 35
  - open projects created on other hosts 35
  - open registers in a separate Registers window 248
  - open subprojects 40
  - open the Breakpoints window 207
  - open the Cache window 318
  - open the Command window 320
  - open the Expressions window 236
  - open the Flash Programmer window 293
  - open the Global Variables window 232
  - open the Hardware Diagnostics window 306
  - open the Log window 261
  - open the Processes window 258, 259
  - open the Profile window 319
  - open the Registers window 247
  - open the Symbolics window 256
  - open the symbols window 174
  - open the Target Settings window 387
  - open the Trace window 317
  - overstrike text (Windows) 95
  - print class hierarchies 169
  - print projects 36
  - remove a keyword from a keyword set 402
  - remove a marker from a source file 111
  - remove all markers from a source file 112
  - remove an executable file 405
  - remove panes from an editor window 91
  - remove remote connections 384
  - remove source trees 364
-

- 
- replace text in a single file 119
  - resize panes in an editor window 91
  - restart the debugger 195
  - resume program execution 194
  - run a program 194
  - save a workspace 76
  - save changes to a workspace 77
  - save projects 35
  - save the contents of the Breakpoints window 208
  - search a single file 117
  - search for text across multiple files 129
  - search for text across multiple folders 123
  - search for text across multiple projects 125
  - search for text across multiple symbolics files 127
  - search with a text selection 134
  - select entire routines 94
  - select item in Code Completion window 103
  - select lines 94
  - select multiple lines 94
  - select rectangular portions of lines 94
  - select text in editor windows 93
  - set a breakpoint 208
  - set a conditional breakpoint 211
  - set a conditional eventpoint 224
  - set a conditional watchpoint 228
  - set a Log Point 216
  - set a Pause Point 218
  - set a Script Point 219
  - set a Skip Point 220
  - set a Sound Point 220
  - set a temporary breakpoint 211
  - set a Trace Collection Off eventpoint 221
  - set a Trace Collection On eventpoint 222
  - set a watchpoint 226
  - set thread-specific breakpoints 212
  - show the classes pane 162
  - sort the classes list 162
  - specify the default breakpoint template 214
  - start the debugger 192
  - step into a routine 193
  - step out of a routine 193
  - step over a routine 193
  - stop program execution 194
  - suppress dockable windows 72
  - toggle automatic punctuation balancing 97
  - toggle the symbol hint 195
  - trigger code completion by keyboard 99
  - trigger code completion from IDE menu bar 98
  - unapply file differences 143
  - undock a window 70
  - unfloat a window 71
  - unindent text blocks 95
  - use contextual menus 197
  - use the default workspace 76
  - use the document settings pop-up 89
  - use the Executables pane in the Symbolics window 257
  - use the Files pane in the Symbolics window 257
  - use the Find Next command 132
  - use the Find Previous command 133
  - use the Functions list pop-up 108
  - use the Functions pane in the Symbolics window 257
  - use the Interfaces list pop-up 108
  - use the symbol hint 196
  - use the VCS pop-up 89
  - use virtual space 95
  - view a file path 47
  - view breakpoint properties 209
  - view browser data by contents 172
  - view browser data by inheritance 168
  - view class data from hierarchy window 160
  - view eventpoint properties 223
  - view global variables for different processes 232
  - view registers 247
  - view watchpoint properties 227
- I**
- icons
    - Active 207
    - file modification 90
    - for data members 163
    - for member functions 163
-

- 
- Inactive 207
  - IDE
    - and threading 415
    - Code Completion window 100
    - Data menu 479
    - Debug menu 476
    - Edit menu 470
    - editing source code 93
    - editor 85
    - File menu 469
    - Flash Programmer window 293
    - Hardware Diagnostics window 306
    - hardware tools 293
    - Help menu 481
    - linkers 329
    - menu reference 469
    - preferences, working with 351
    - project manager and build targets 29
    - Project menu 474
    - Search menu 473
    - target settings, working with 385
    - tools overview 24
    - User's Guide overview 17
    - Window menu 472, 481
    - Windows-hosted 343
    - workspaces 75
  - IDE Extras panel
    - options
      - Documents 417
      - Find Reference using 421
      - Launch Editor 425
      - Launch Editor w/ Line # 425
      - Menu bar layout 427
      - Projects 429
      - Symbolics 440
      - Use External Editor 441
      - Use Multiple Document Interface 443
      - Use Script menu 443
      - Use ToolServer menu 444
      - Workspaces 446
      - Zoom windows to full screen 447
  - IDE Extras preference panel 355
    - options
      - Context popup delay 357
      - Documents 356
      - Launch Editor 357
      - Launch Editor w/ Line # 357
      - Menu bar layout 356
      - Projects 356
      - Recent symbolics 356
      - Use External Editor 357
      - Use Multiple Document Interface 357
      - Use Script menu 357
      - Use Third Party Editor 357
      - Zoom windows to full screen 357
  - Use Third Party Editor option 444
  - IDE Preference Panels list 352
  - IDE Preference Panels, Font & Tabs 372
  - IDE Preference Panels, Font Settings 372
  - IDE preferences
    - Activate Browser Coloring 374
    - Activate Syntax Coloring 374
    - Add 361, 363, 382
    - Attempt to use dynamic type of C++, Object Pascal and SOM objects 378
    - Auto Indent 372
    - Auto Target Libraries 381
    - Automatic Invocation 366
    - Automatically launch applications when SYM file opened 380
    - Background 373
    - Balance Flash Delay 370
    - Balance while typing 370
    - Browser Commands 369
    - Browser Path 359
    - Build before running 354
    - Cache Edited Files Between Debug Sessions 380
    - Case sensitive 366
    - Change 361, 363, 382
    - Choose 363
    - Classes 374
    - Close Braces, Brackets, And Parentheses 368
    - Close I/O console on process death 381
    - Close non-debugging windows 379
    - Code Completion Delay 366
    - Collapse non-debugging windows 379
-



- 
- Comments 374
  - Compiler thread stack 354
  - Confirm "Kill Process" when closing or quitting 381
  - Confirm invalid file modification dates when debugging 380
  - Constants 374
  - Context popup delay 357
  - Debugger Commands 370
  - Default file format 370
  - Default size for unbounded arrays 378
  - Disable third party COM plugins 360
  - Display deprecated items 366
  - Do nothing to project windows 379
  - Documents 356
  - Don't step into runtime support code 381
  - Drag and drop editing 370
  - Edit 374
  - Edit Commands 369
  - Enable Virtual Space 370
  - Enums 374
  - Failure 354
  - Find and compare operations 361
  - Font 371
  - Font preferences 369
  - Foreground 373
  - Format Braces 367
  - frames 380
  - Functions 374
  - Globals 374
  - Hide non-debugging windows 379
  - Indent Braces 368
  - Indent Case Within Switch Statement 368
  - Indent Code Within Braces 368
  - Keywords 374
  - Language Settings 367
  - Launch Editor 357
  - Launch Editor w/ Line # 357
  - Left margin click selects line 370
  - Level 360
  - Limit Stack Crawls 380
  - Macros 374
  - Menu bar layout 356
  - Minimize non-debugging windows 379
  - Name 363
  - On IDE Start:Do Nothing 358
  - Open Empty Text Document 358
  - Other 375
  - Place Else On Same Line As Closing Brace 368
  - Place Opening Brace On Separate Line 367
  - Play sound after 'Bring Up To Date' & 'Make' 354
  - Plugin Startup Actions 358
  - Project Commands 369
  - Project operations 361
  - Projects 356
  - Purge after 380
  - Purge Now 380
  - Recent symbolics 356
  - Recommended 355
  - Re-execute target init script even if already connected 381
  - Regular Expression 361
  - Relaxed C popup parsing 370
  - Remote Connection list 382
  - Remove 361, 363, 382
  - Reopen I/O console as needed 381
  - Restore Default Workspace 358
  - Save open files before build 354
  - Script 371
  - Select thread window when stopping task 381
  - Selection position 369
  - SEt 359
  - Set 1, Set 2, Set 3, Set 4 374
  - Shielded folder list 361
  - Show all locals 377
  - Show message after building up-to-date project 354
  - Show tasks in separate windows 379
  - Show values as decimal instead of hex 378
  - Show variable location 377
  - Show variable types 377
  - Show variable values in source code 378
  - Size 371
  - Sort function popup 370
-

- 
- Sort functions by method name in symbolics
    - window 378
  - Source Tree list 363
  - Strings 374
  - Success 354
  - Tab indents selection 371
  - Tab Inserts Spaces 372
  - Tab Size 371
  - Templates 374
  - Type 363
  - TypeDefs 375
  - Use "not found" dialog 370
  - Use Automatic Code Formatting 367
  - Use Concurrent Compiles 355
  - Use External Editor 357
  - Use Local Project Data Storage 354
  - Use Multiple Document Interface 357
  - Use multiple undo 370
  - Use Script menu 357
  - Use Third Party Editor 357
  - User Specified 355
  - Variable values change 377
  - VCS Commands 369
  - Watchpoint indicator 377
  - When Debugging Starts:Do nothing 379
  - Window follows insertion point 366
  - Window position and size 369
  - Zoom windows to full screen 357
  - IDE Preferences window 227, 334, 351, 352
    - Apply button 353
    - Cancel button 353
    - Factory Settings button 334, 352
    - IDE Preference Panels list 352
    - Import Panel 424
    - Import Panel button 334, 352
    - OK button 352
    - Revert Panel button 334, 352
    - Save button 334, 353
  - IDE Startup
    - options
      - On IDE Start: Do Nothing option 428
      - Open Empty Text Document 428
      - Restore Default Workspace 432
  - IDE Startup panel
    - options
      - Plugin Startup Actions 428
  - IDE Startup preference panel 357
    - options
      - Do Nothing 358
      - Open Empty Text Document 358
      - Plugin Startup Actions 358
      - Restore Default Workspace 358
  - Ignore Extra Space checkbox 139
  - Ignored By Make File flag 396
  - Import button 349
  - Import Commands 348
  - Import Components menu command 498
  - Import Panel 424
  - Import Project command 37
  - Import Project menu command 498
  - importing
    - projects saved as XML files 37
  - In Files page 128, 129
  - In Files tab 122
  - In Folders page 122, 123
  - In Folders tab 122
  - In Projects page 124, 125
  - In Projects tab 122
  - In Symbolics page 126, 127
  - In Symbolics tab 122
  - Inactive icon 207
  - Include Files 181
  - Include files 178
  - indenting
    - text blocks 95
  - Initial Directory field
    - Build Extras panel 424
  - Initializer 183
  - Insert Reference Template menu command 498
  - inspecting
    - project files 36
  - Installed Products button 483
  - Instances tab 206
  - Instruction Scheduling 400
  - interface files
    - locating 107
  - Interface menu 53
  - Interfaces list pop-up
-

---

- in Files view of Project window 46
- using 108
- interfaces list pop-up 88
- interrupt time
  - and profiler 290
- interrupt time, and profiler 289
- IP Address field 383

## J

- Java 325
- Java Exceptions Submenu
  - No Exceptions command 500
- Java Exceptions submenu
  - All Exceptions command 484
  - Exceptions In Targeted Classes command 493
  - Uncaught Exceptions Only command 515
- Java submenu 484, 493, 500, 515

## K

- Key Bindings 335
  - Add 347
  - Customize 345
- key bindings 113
- keyboard conventions 19
- keyboard shortcuts
  - Find symbols with prefix 96
  - Find symbols with substring 96
  - Get next symbol 96
  - Get previous symbol 96
- keys
  - Quote Key prefix 349
- keywords
  - adding to a keyword set 401
  - removing from a keyword set 402
- Keywords option
  - Text Colors panel 425
- Kill button 189
- Kill command 194
- Kill menu command 498
- killing program execution 194

## L

- Language Parser option, in Generate Browser Data From menu 423
- Launch Editor option
  - IDE Extras panel 425
- Launch Editor w/ Line # option
  - IDE Extras panel 425
- Launch Remote Host Application option
  - Remote Debugging settings panel 425
- Launchable flag 396
- Layout Editor panel
  - options
    - Grid Size X 423
    - Grid Size Y 423
    - Show the component palette when opening a form 436
    - Show the object inspector when opening a form 436
- layout management 50
- layouts
  - moving 52
  - removing 50
  - renaming 52
- least significant bit 315, 454
- Left Edges command 498
- Left margin click selects line option
  - Editor Settings panel 426
- Level option
  - Plugin Settings panel 426
- libraries 329
  - profiler 271
- Lifetime Based Register Allocation 400
- Limit Stack Crawls option 426
- line
  - going to in source code 109
- Line And Column button 192
- line and column indicator, in editor window 91
- %line command-line string 425
- Line Display 168
- lines, selecting 94
- lines, selecting multiple 94
- lines, selecting rectangular portions of 94
- link maps
  - generating for projects 330

- 
- link order 326
  - Link Order page 49
  - Link Order tab 50
  - Link Order view 36, 52, 326
  - linker 329
  - Linker option
    - Target Settings panel 426
  - linkers 329
    - choosing 329
  - linking projects 330
  - list
    - of symbols in Browser Contents window 171
  - list boxes
    - Bit Value Modifier 251
    - Bitfield Name 250
    - Connection 296, 308
    - File Set 129
    - Format 250
    - Functions 191
    - Processor Family 296, 308
    - Project 125
    - Source 192
    - Symbolics 127
    - Target 125
    - Text View 252, 253
  - list menus
    - document settings 89
    - functions 88
    - interfaces 88
    - markers 88
    - VCS 89
  - list pop-up menus
    - Current Target 44
  - list pop-ups
    - Ancestor 168
    - Browser Access Filters 156
    - document settings 89
    - functions 88
    - interfaces 88
    - markers 88
    - Symbols 171
    - VCS 158
  - lists
    - All Sectors 303
    - File 125
    - File Mappings 414
    - File Set 129
    - Symbolics 127
    - Live Range Splitting 399
    - Load Settings button 294, 307
    - locating functions 107, 108
    - locating interface files 107
    - locating source code 107
    - Location of Relocated Libraries and Code Resources option
      - Debugger Settings panel 427
    - Log Message checkbox 217
    - Log Point 215, 216
    - Log Point Settings window 217
      - Message text box 217
      - Speak Message checkbox 217
      - Stop in Debugger checkbox 217
      - Treat as Expression checkbox 217
    - Log Point, clearing 217
    - Log Point, setting 216
    - Log System Messages 260
    - Log System Messages option
      - Debugger Settings panel 427
    - Log Window
      - Log System Messages option 260
    - Log window 260
      - opening 261
    - Long Word option button 309, 311, 314
    - longjmp() 275
    - looking up symbol definitions 112
    - Loop Transformations 400
    - Loop Unrolling 400
    - Loop Unrolling (Opt For Speed Only) 400
    - Loop-Invariant Code Motion 400
    - LSB 315
- M**
- machines, defined 258
  - Macintosh
    - creating files 60
  - Macro file option, in Generate Browser Data
    - From menu 423
-

- 
- Macros option 374
  - Make 327, 330
    - binary files 327
  - Make command 52, 53, 54
  - Make menu command 499
  - Make option 421
  - Make toolbar button 44
  - Makefile Importer wizard 33
  - makefiles
    - converting into projects 33
  - managing
    - build targets 54
    - projects 32
    - targets 54
  - managing files, tasks 59
  - manipulating program execution 203
    - Breakpoints window 204
  - manual conventions 19
  - map file 330
  - markers 110
    - adding to a source file 111
    - navigating to 111
    - removing all from source files 112
    - removing from source files 111
  - Markers list pop-up 88
  - Markers list, in Remove Markers window 111
  - Match Whole Word checkbox 116, 118, 121
  - matching
    - any character with regular expressions 135, 136
    - replace strings to find strings with regular expressions 136, 137
    - with simple regular expressions 135
  - Maximize Window menu command 499
  - Maximum Invert Convergence subtest 316
  - .mcp 35
  - MDI 357, 427, 443
    - and dockable windows 65
    - making a window an MDI child 71
  - Member Function Declaration 180
  - member functions
    - creating 163, 180
    - identifier icons 163
  - Member Functions pane 163
    - in Class Browser window 157
  - memory aliasing, defined 315
  - memory dump 517
  - Memory Range On Target option button 305
  - Memory Read / Write panel 308
  - memory tests
    - Address 315
    - Bus Noise 316
      - address lines 316
      - data lines 317
    - Bus Noise test
      - Full Range Converging subtest 316
      - Maximum Invert Convergence subtest 316
      - Sequential subtest 316
    - Walking Ones 314
    - Walking Ones test
      - Address Line fault 315
      - Data Line fault 315
      - Ones Retention subtest 315
      - Retention fault 315
      - Walking Ones subtest 315
      - Walking Zeros subtest 315
      - Zeros Retention subtest 315
  - Memory Tests panel 312
    - Address test 315
    - Bus Noise test 316
      - address lines 316
      - data lines 317
    - Walking Ones test 314
  - Memory Usage 286
  - memory usage 286
  - Memory window 239
  - memory, working with 239
  - Menu
    - Current Target 344
  - menu
    - Search 113
  - Menu bar layout option
    - IDE Extras panel 427
  - menu commands
    - About Freescale CodeWarrior 483
    - Add Files 483
    - Add Window 483
-

- 
- Apply Difference 143, 484
  - Balance 485
  - Bottom Edges 485
  - Break 485
  - Break On C++ Exception 485
  - Break on Java Exceptions 485
  - Breakpoints 485
  - Breakpoints Window 485
  - Bring To Front 485
  - Bring Up To Date 486
  - Browser Contents 486
  - Build Progress 486
  - Build Progress Window 486
  - Can't Redo 471
  - Can't Undo 471
  - Cascade 486
  - Change Program Counter 486
  - Check Syntax 486
  - Class Browser 487
  - Class Hierarchy 487
  - Class Hierarchy Window 487
  - Clear 487
  - Clear All Breakpoints 487
  - Clear All Watchpoints 487
  - Clear Breakpoint 487
  - Clear Eventpoint 487
  - Clear Watchpoint 488
  - Close 488
  - Close All 488
  - Close All Editor Documents 488
  - Close Catalog 488
  - Close Workspace 488
  - CodeWarrior Help 489
  - CodeWarrior Website 489
  - Collapse Window 489
  - Commands & Key Bindings 489
  - Compare Files 139, 489
  - Compile 490
  - Complete Code 489
  - Connect 490
  - Copy 490
  - Copy To Expression 490
  - Create Design 490
  - Create Group 490
  - Create Target 491
  - Cycle View 491
  - Debug 491
  - Delete 503
  - Disable Breakpoint 492
  - Disable Watchpoint 492
  - Disassemble 492
  - Display Grid 492
  - Enable Breakpoint 492
  - Enable Watchpoint 492
  - Enter Find String 133, 493
  - Enter Replace String 493
  - Errors And Warnings 493
  - Errors And Warnings Window 493
  - Exit 493
  - Expand Window 493
  - Export Project 494, 498
  - Expressions 494
  - Expressions Window 494
  - Find 117, 494
  - Find and Open 'Filename' 495
  - Find and Open File 495
  - Find And Replace 496
  - Find Definition 494
  - Find Definition & Reference 494
  - Find In Files 495
  - Find In Next File 495
  - Find In Previous File 495
  - Find Next 132, 495
  - Find Previous 133, 495
  - Find Previous Selection 495
  - Find Reference 496
  - Find Selection 134, 496
  - Get Next Completion 496
  - Get Previous Completion 496
  - Global Variables 496
  - Global Variables Window 496
  - Go Back 497
  - Go Forward 497
  - Go To Line 497
  - Hide Breakpoints 497
  - Hide Window Toolbar 497
  - Import Components 498
  - Import Project 498

- 
- Insert Reference Template 498
  - Kill 498
  - Make 499
  - Maximize Window 499
  - Minimize Window 499
  - New 499
  - New Class 499
  - New Class Browser 499
  - New Data 499
  - New Event 500
  - New Event Set 500
  - New Expression 500
  - New Member Function 500
  - New Method 500
  - New Property 500
  - New Text File 500
  - Open 501
  - Open Recent 501
  - Open Scripts Folder 501
  - Open Workspace 501
  - Page Setup 501
  - Precompile 502
  - Preferences 502
  - Print 502
  - Processes 502
  - Processes Window 502
  - Redo 503
  - Refresh All Data 503
  - Register Details Window 249, 503
  - Register Windows 503
  - Registers 503
  - Remove Object Code 504
  - Remove Object Code & Compact 504
  - Remove Toolbar Item 344
  - Replace 119, 504, 505
  - Replace All 504
  - Replace and Find Next 504
  - Resume 506
  - Revert 507
  - Run 429, 507
  - Run To Cursor 507
  - Save Default Window 508
  - Save Workspace 508
  - Save Workspace As 508
  - Select All 508
  - Send To Back 508
  - Set Breakpoint 508
  - Set Default Project 509
  - Set Default Target 509
  - Set Eventpoint 509
  - Set Watchpoint 509
  - Shift Right 509
  - Show Breakpoints 487, 510
  - Show Types 510
  - Show Window Toolbar 497
  - Stack Editor Windows 510
  - Step Over 510
  - Stop Build 511
  - Switch To Monitor 511
  - Symbolics 511
  - Symbolics Window 511
  - Synchronize Modification Dates 511
  - Unapply Difference 143
  - View Array 515
  - View As Unsigned Decimal 515, 516, 517
  - View Disassembly 517
  - View Mixed 517
  - View Source 518
  - View Variable 518
  - Zoom Window 518
  - menu layouts
    - Windows 469
  - menu reference
    - for IDE 469
  - menus 156
    - contextual 196
    - VCS 165
  - Message text box 217
  - microsecondsTimeBase 273, 287
  - Minimize non-debugging windows option
    - Windowing panel 427
  - Minimize Window menu command 499
  - most significant bit 315, 454
  - moving
    - build targets 52
    - dockable windows 73
    - files 52
    - groups 52
-

---

- layouts 52
- targets 52
- MSB 315
- Multi-Class Hierarchy window 167, 170
- multi-core debugging 197
- Multiple Document Interface. *See* MDI.
- multiple files, searching 129
- multiple folders, searching 123
- multiple projects, searching 125
- multiple Redo 503
- multiple symbolics files, searching 127
- multiple Undo 503
- multiple-file Find and Replace window 120

## N

- NAME 451, 453
- Name field 335
- name, breakpoint property 209
- navigating
  - browser data 152
  - Code Completion window 102
  - to markers 111
- navigating data 152
- navigating source code 107
- New Binding 335, 347
- New C++ Class window 176
- New C++ Data Member window 183
- New C++ Member Function window 180
- New Class Browser menu command 499
- New Class menu command 499
- New Class wizard 162, 175, 176
- New Command 336
- New command 59, 80
- New Command Group
  - Create 335
- New Connection dialog box 382
- New Data Member 164, 180, 182
- new data member functions
  - creating 181
- New Data Member wizard 164, 181, 182
- New Data menu command 499
- New Event menu command 500
- New Event Set menu command 500
- New Expression menu command 500

- New Group 335
- New Item 161
- New Member Function menu command 500
- New Member Function wizard 163, 179, 180
- new member functions
  - creating 179
- New Menu Command
  - Create 336, 339
- New menu command 499
- New Method menu command 500
- New Property menu command 500
- New Text File command 60
- New Text File menu command 500
- Next Result button 132
- No Exceptions command 500
- None option
  - of Plugin Diagnostics 426
- None option, in Generate Browser Data From
  - menu 422
- non-executable file 327
- non-modal, defined 67
- NOT 452
- notes
  - for the latest release 17
- Numeric Keypad Bindings 347
- Numeric Keypad Bindings checkbox
  - of Customize IDE Commands window 350

## O

- object code 329
  - remove 328
- object performance 281
- Object View 282
- octal 450, 454, 457
- Offset text box 301
- OK button 295, 307
- On IDE Start: Do Nothing option 428
- Ones Retention subtest 315
- Only Show Different Files checkbox 139
- Open command 60
- Open Empty Text Document option 428
- Open File 165
- Open In Windows Explorer command 47
- Open menu command 501



- 
- Open Recent menu command 501
  - Open Scripts Folder menu command 501
  - Open Workspace menu command 501
  - opening 174
    - a recent workspace 77
    - a single-class hierarchical window 170
    - files 60
    - Flash Programmer window 293
    - Hardware Diagnostics window 306
    - projects 35
    - projects from other hosts 35
    - subprojects 40
    - Symbolics window 256
    - symbols window 174
    - workspaces 77
  - openings
    - registers in a separate Registers window 248
  - optimizations
    - Arithmetic Optimizations 399
    - Branch Optimizations 399
    - Common Subexpression Elimination 399
    - Copy And Expression Propagation 399
    - Copy Propagation 399
    - Dead Code Elimination 399
    - Dead Store Elimination 399
    - Expression Simplification 399
    - Global Register Allocation 399
    - Global Register Allocation Only For
      - Temporary Values 399
    - Instruction Scheduling 400
    - Lifetime Based Register Allocation 400
    - Live Range Splitting 399
    - Loop Transformations 400
    - Loop Unrolling 400
    - Loop Unrolling (Opt For Speed Only) 400
    - Loop-Invariant Code Motion 400
    - Peephole Optimization 399
    - Register Coloring 400
    - Repeated 400
    - Strength Reduction 400
    - Vectorization 400
  - option buttons
    - All text 116, 119, 122
    - Byte 309, 311, 313
    - Code Only 117, 119, 122
    - Comments Only 117, 119, 122
    - Entire Flash 305
    - File on Host 305
    - File on Target 305
    - Long Word 309, 311, 314
    - Memory Range on Target 305
    - Read 309, 311
    - Word 309, 311, 314
    - Write 309, 311
  - options 417
    - Access Paths settings panel 360, 389
    - Activate Browser 494
    - Activate Browser Coloring 409
    - Activate Syntax Coloring 409, 414
    - Add Default 409
    - Always Search User Paths 409
    - Application 410
    - Arguments 410
    - Attempt to use dynamic type of C++, Object
      - Pascal and SOM objects 410
    - Auto Indent 410
    - Auto Target Libraries 410
    - Automatic Invocation 410
    - Automatically Launch Applications When
      - SYM File Opened 411
    - Auto-target Libraries 410
    - Background 411
    - Balance Flash Delay 411
    - Balance while typing 411, 412
    - Bring Up To Date 421
    - Browse in processes window 383, 384
    - Browser Commands 412
    - Browser Path 412
    - Build before running 412
    - Build Extras settings panel 391
    - Build Settings preference panel 353
    - Cache Edited Files Between Debug
      - Sessions 413
    - Cache Subprojects 413
    - Cache symbolics between runs 413
    - Case Sensitive 413
    - Checksum panel 304
-

- 
- choosing host application for non-executable files 423
  - Classes 374
  - Close non-debugging windows 414
  - Code Completion Delay 414
  - Code Completion preference panel 365
  - Code Formatting preference panel 366
  - Collapse non-debugging windows 414
  - Comments 414
  - Compiler 414
  - Compiler thread stack 415
  - Concurrent Compiles preference panel 355
  - Configuration panel 307
  - Confirm “Kill Process” when closing or quitting 415
  - Confirm invalid file modification dates when debugging 415
  - Connection Type 383, 384
  - Constants 374
  - Context popup delay 415
  - Debugger Commands 416
  - Debugger preference panels 376
  - Debugger Settings 260
  - Debugger Settings panel 405
  - Default File Format 416
  - Default size for unbounded arrays 416
  - Disable third party COM plugins 416
  - Display Deprecated Items 416
  - Display Settings preference panel 376
  - Do nothing to project windows 417
  - Drag and drop editing 417
  - Dump internal browse information after compile 417
  - Edit Commands 417
  - Edit Language 418
  - Editor preference panels 365
  - Editor Settings preference panel 368
  - Enable automatic Toolbar help 418
  - Enable remote debugging 418
  - Enable Virtual Space 418
  - Enums 374
  - Environment Settings 418
  - Erase / Blank Check panel 302
  - Failure 421
  - File Mappings settings panel 395
  - File Type 414
  - Flash Configuration panel 297
  - Font & Tabs preference panel 370, 373
  - Functions 374
  - General preference panels 353
  - Generate Browser Data From 422
  - Global Optimizations settings panel 397
  - Globals 374
  - Help Preferences panel 358
  - IDE Extras preference panel 355
  - IDE Startup preference panel 357
  - Import Panel 424
  - Macros 374
  - Make 421
  - Memory Read / Write panel 308
  - Memory Tests panel 312
  - Other 375
  - Other Executables settings panel 402
  - Plugin Settings preference panel 359
  - Program / Verify panel 299
  - Purge Cache 413
  - Remote Connections preference panel 381
  - Remote Debugging settings panel 406
  - Require Framework Style Includes 431
  - Runtime Settings panel 393
  - Scope Loop panel 310
  - Set 1, Set 2, Set 3, Set 4 374
  - setting for browser 149
  - Shielded Folders preference panel 360
  - Source Trees preference panel 362
  - Target Configuration panel 295
  - Target Settings panel 387
  - Templates 374
  - TypeDefs 375
  - Use Multiple Document Interface 65
  - User specified 406
  - When Debugging Starts:Do nothing 446
  - Window Follows Insertion Point 446
  - Window Settings preference panel 378
  - OR 452
  - order
    - build 326
    - link 326

- 
- Organization pane 299
  - original process, breakpoint property 210
  - original-target, breakpoint property 210
  - other editor windows 90
  - Other Executables settings panel 402
  - Other option 375
  - Output Directory option
    - Target Settings panel 428
  - Overlays tab 50
  - Overlays view 326
  - overstrike 95
  - overstriking text (Windows) 95
  - overtyping. *See* overstrike.
  - overview
    - of browser 25
    - of build system 26
    - of CodeWarrior 21
    - of debugger 26
    - of editor 25
    - of IDE project manager and build targets 29
    - of IDE tools 24
    - of IDE User's Guide 17
    - of project manager 25
    - of search engine 25
- P**
- Page Setup command 501
  - pages
    - In Files 128
    - In Folders 122
    - in project window 45
    - In Projects 124
    - In Symbolics 126
  - PalmQuest reference 421
  - Pane Collapse 161
  - Pane Collapse box 145, 190
  - Pane Expand 160
  - Pane Expand box 145, 190
  - Pane resize bar 132, 142, 145, 190
  - pane resize bar
    - in File Compare Results window 142
    - in Folder Compare Results window 145
  - pane splitter and resize controls, in editor window 91
  - panel
    - Display Settings 227
  - panels
    - Font & Tabs 372
  - panes
    - adding to editor window 91
    - Destination 142
    - Device 298
    - Differences 143
    - Files in Both Folders 145
    - Files Only in Destination 146
    - Files Only in Source 145
    - Flash Programmer 294
    - Hardware Diagnostics 306
    - Organization 299
    - removing from editor window 91
    - resizing in an editor window 91
    - Results 132
    - Sector Address Map 299
    - Source 142, 191
    - Source Code 132
    - Stack 190
    - Variables 190
  - parameter lists
    - completing code 104
  - Passes text box 314
  - path caption 90
  - Pause Point 215, 218
  - Pause Point, clearing 218
  - Pause Point, setting 218
  - Peephole Optimization 399
  - Play sound after 'Bring Up To Date' & 'Make' option
    - Build Settings panel 428
  - Plugin Diagnostics
    - All Info option 426
    - Errors Only option 426
    - None option 426
  - plug-in diagnostics
    - disabling 483
    - enabling 483
  - Plugin Settings panel options
    - Level 426
-

- 
- Plugin Settings preference panel 359
    - options
      - Disable third party COM plugins 360
      - Level 360
  - Plugin Startup Actions
    - IDE Startup panel 428
  - plug-ins
    - saving information about those installed in IDE 483
    - viewing those installed in IDE 483
  - pop-up menus
    - document settings 89
    - functions 88
    - interfaces 88
    - markers 88
    - VCS 89
  - pop-ups
    - Ancestor 168
    - Browser Access Filters 156
    - Symbols 171
    - VCS 158
  - Post-linker option
    - Target Settings panel 429
  - PPCTimeBase 274, 287
  - Precompile menu command 502
  - Precompiled File flag 396
  - preference panels
    - Build Settings 353
    - Code Completion 365
    - Code Formatting 366
    - Concurrent Compiles 355
    - Display Settings 376
    - Editor Settings 368
    - Font & Tabs 370, 373
    - Help Preferences 358
    - IDE Extras 355
    - IDE Startup 357
    - Plugin Settings 359
    - Remote Connections 381
    - reverting 432
    - Shielded Folders 360
    - Source Trees 362
    - Window Settings 378
  - preferences
    - Activate Browser Coloring 374
    - Activate Syntax Coloring 374
    - Add 361, 363, 382
    - Apply button 353
    - Attempt to use dynamic type of C++, Object Pascal and SOM objects 378
    - Auto Indent 372
    - Auto Target Libraries 381
    - Automatic Invocation 366
    - Automatically launch applications when SYM file opened 380
    - Background 373
    - Balance Flash Delay 370
    - Balance while typing 370
    - Browser Commands 369
    - Browser Path 359
    - Build before running 354
    - Cache Edited Files Between Debug Sessions 380
    - Cancel button 353
    - Case sensitive 366
    - Change 361, 363, 382
    - Choose 363
    - Classes 374
    - Close Braces, Brackets, And Parentheses 368
    - Close I/O console on process death 381
    - Close non-debugging windows 379
    - Code Completion Delay 366
    - Collapse non-debugging windows 379
    - Comments 374
    - Compiler thread stack 354
    - Confirm "Kill Process" when closing or quitting 381
    - Confirm invalid file modification dates when debugging 380
    - Constants 374
    - Context popup delay 357
    - Debugger 376
    - Debugger Commands 370
    - Default file format 370
    - Default size for unbounded arrays 378
    - Disable third party COM plugins 360
    - Display deprecated items 366
-

- 
- Do nothing to project windows 379
  - Documents 356
  - Don't step into runtime support code 381
  - Drag and drop editing 370
  - Edit 374
  - Edit Commands 369
  - Editor 365
  - Enable Virtual Space 370
  - Enums 374
  - Export Panel button 334, 352
  - Factory Settings button 334, 352
  - Failure 354
  - Find and compare operations 361
  - Font 371
  - Font preferences 369
    - for IDE 351
  - Foreground 373
  - Format Braces 367
  - frames 380
  - Functions 374
    - General 353
    - Globals 374
  - Hide non-debugging windows 379
  - IDE Preference Panels list 352
  - IDE window 351
  - Import Panel button 334, 352
  - Indent Braces 368
  - Indent Case Within Switch Statement 368
  - Indent Code Within Braces 368
  - Keywords 374
  - Language Settings 367
  - Launch Editor 357
  - Launch Editor w/ Line # 357
  - Left margin click selects line 370
  - Level 360
  - Limit Stack Crawls 380
  - Macros 374
  - Menu bar layout 356
  - Minimize non-debugging windows 379
  - Name 363
  - OK button 352
  - On IDE Start:Do Nothing 358
  - Open Empty Text Document 358
  - Other 375
    - Place Else On Same Line As Closing Brace 368
    - Place Opening Brace On Separate Line 367
    - Play sound after 'Bring Up To Date' & 'Make' 354
    - Plugin Startup Actions 358
    - Project Commands 369
    - Project operations 361
    - Projects 356
    - Purge after 380
    - Purge Now 380
    - Recent symbolics 356
    - Recommended 355
    - Re-execute target init script even if already connected 381
    - Regular Expression 361
    - Relaxed C popup parsing 370
    - Remote Connection list 382
    - Remove 361, 363, 382
    - Reopen I/O console as needed 381
    - Restore Default Workspace 358
    - Revert Panel button 334, 352
    - Save button 334, 353
    - Save open files before build 354
    - Script 371
    - Select thread window when stopping task 381
    - Selection position 369
    - Set 359
    - Set 1, Set 2, Set 3, Set 4 374
    - Shielded folder list 361
    - Show all locals 377
    - Show message after building up-to-date project 354
    - Show tasks in separate window 379
    - Show values as decimal instead of hex 378
    - Show variable location 377
    - Show variable types 377
    - Show variable values in source code 378
    - Size 371
    - Sort function popup 370
    - Sort functions by method name in symbolics window 378
    - Source Tree list 363

- 
- Strings 374
  - Success 354
  - Tab indents selection 371
  - Tab Inserts Spaces 372
  - Tab Size 371
  - Templates 374
  - Type 363
  - TypeDefs 375
  - Use "not found" dialog 370
  - Use Automatic Code Formatting 367
  - Use Concurrent Compiles 355
  - Use External Editor 357
  - Use Local Project Data Storage 354
  - Use Multiple Document Interface 357
  - Use multiple undo 370
  - Use Script menu 357
  - Use Third Party Editor 357
  - User Specified 355
  - Variable values change 377
  - VCS Commands 369
  - Watchpoint indicator 377
  - When Debugging Starts:Do nothing 379
  - Window follows insertion point 366
  - Window position and size 369
  - Zoom windows to full screen 357
  - Preferences menu command 502
  - Prefix file option, in Generate Browser Data From menu 423
  - prefix keys
    - Quote Key 349
  - Pre-linker option
    - Target Settings panel 429
  - preprocessor directives 272
    - C/C++ 285
  - Previous Result button 132
  - print
    - file selections 63
  - Print command 63, 502
  - printing
    - class hierarchies 169
    - files 63
    - projects 36
  - process
    - attaching debugger to 260
    - process cycle
      - of software development 21
    - processes
      - related to machines 258
      - viewing global variables for 232
    - Processes menu command 502
    - Processes window 258, 383
      - opening 258, 259
    - Processes Window menu command 502
    - Processor Family list box 296, 308
    - products
      - saving information about those installed in IDE 483
      - viewing those installed in IDE 483
  - Profile window
    - opening 319
  - Profiler 278
    - Library 284
  - profiler
    - libraries 271
  - Profiler Function Reference 287
    - ProfilerClear() 291
    - ProfilerDump() 291
    - ProfilerGetDataSizes() 290
    - ProfilerGetStatus() 290
    - ProfilerInit() 288
    - ProfilerSetStatus() 289
    - ProfilerTerm() 289
  - ProfilerClear() 291
  - ProfilerDump() 276, 291
  - ProfilerGetDataSizes() 290
  - ProfilerGetStatus() 290
  - ProfilerInit() 290, 291
    - warning 276
  - ProfilerSetStatus() 289
  - ProfilerTerm() 276
  - ProfilerTerm() 276, 289
    - warning 276, 277
  - profiling
    - activating 268
    - by function 269, 285
    - exceptions 275
    - inline functions 284
-

- 
- setjmp() 275
  - program
    - killing execution 194
    - resuming execution 194
    - running 194
    - stopping execution 194
  - Program / Verify panel 299
  - Program Arguments field
    - of Runtime Settings panel (Windows) 429
  - Program Arguments option
    - Runtime Settings panel 429
  - Program button 302
  - Program Entry Point option
    - Debugger Settings panel 429
  - program execution, manipulating 203
  - project
    - Bring Up To Date 327
    - compiling 325
    - Make 330
    - update 327
  - Project Commands option
    - Editor Settings panel 429
  - project data folder 442
  - Project Headers checkbox 125
  - Project Inspector command 36
  - Project list box 125
  - project manager 29
    - overview 25
  - Project menu 429, 474
    - Remove Object Code command 476
    - Stop Build command 476
  - Project operations option
    - Shielded Folders panel 429
  - Project Settings 268
  - Project Sources checkbox 125
  - project stationery
    - creating 38
    - custom 38
  - Project window
    - about Files page 45
    - Current Target list pop-up 44
    - Files view
      - Checkout Status column 46
      - Code column 46
      - Data column 46
      - Debug column 46
      - File column 46
      - Interfaces list pop-up 46
      - Sort Order button 46
      - Target column 46
      - Touch column 46
    - Make toolbar button 44
    - Synchronize Modification Dates toolbar
      - button 44
    - Target Settings toolbar button 44
  - project window 43
    - Link Order page 49
    - pages 45
    - Targets page 49
  - project window, about 43
  - project, defined 29
  - projects
    - about subprojects 39
    - advanced topics 38
    - choosing default 37
    - closing 38
    - creating custom stationery 38
    - creating empty 34
    - creating subprojects 39
    - creating using makefiles 33
    - creating using stationery 33
    - data folder 442
    - exporting to XML files 37
    - generating link maps for 330
    - importing XML versions of 37
    - inspecting files 36
    - linking 330
    - managing 32
    - opening 35
    - opening from other hosts 35
    - printing 36
    - project window 43
    - project window pages 45
    - project window, about 43
    - saving 35
    - searching (multiple) 125
    - strategies for 40
    - subprojects, strategies for 41
-

- 
- working with 29
  - Projects option
    - IDE Extras panel 429
  - properties
    - condition, breakpoint 209
    - file-info, breakpoint 209
    - hit count, breakpoint 209
    - name, breakpoint 209
    - original process, breakpoint 210
    - original-target, breakpoint 210
    - serial number, breakpoint 209
    - thread, breakpoint 210
    - times left, breakpoint 210
    - type, breakpoint 209
  - punctuation balancing, toggling 97
  - punctuation, balancing 96
  - pure virtual
    - icon for 163
  - Purge after option
    - Global Settings panel 430
  - Purge Cache option 413
  - Purge Now button 430
  - purging cache 430
  - purpose
    - of breakpoints 203
    - of Browser Contents window 171
    - of Classes pane in browser 161
    - of Data Members pane 164
    - of eventpoints 203
    - of Member functions pane 163
    - of Multi-Class Hierarchy window 167
    - of Single-Class Hierarchy window 170
    - of Source pane 164
    - of special breakpoints 203
    - of status area in browser 165
    - of Symbols window 172
    - of watchpoints 203
- Q**
- Quote Key prefix 349
    - assigning 349
- R**
- read access 454
  - Read button 251
  - Read option button 309, 311
  - readwrite access 455
  - Recurse Subtargets and Subprojects 328
  - Recursive Search column, in Access Paths panel 391
  - Redo button 143
  - Redo menu command 503
  - Re-execute target init script even if already connected option 430
  - reference information
    - for IDE menus 469
  - references
    - XML 466
  - Refresh All Data menu command 503
  - REGISTER 451
  - Register Coloring 400
  - Register Description option
    - of Text View pop-up menu 253
  - Register Details 449
  - Register Details option
    - of Text View pop-up menu 253
  - Register Details window 249
    - Address text box 250
    - Bit Value Modifier list box 251
    - Bit Value text box 251
    - Bitfield Description text view option 253
    - Bitfield Name list box 250
    - Browse button 250
    - Description 251
    - Description File text box 250, 252
    - Format list box 250
    - Read button 251
    - Register Description text view option 253
    - Register Details text view option 253
    - Register display 250, 252
    - Register Name 250
    - Reset Value button 252
    - Revert button 251
    - Text View list box 252, 253
    - using 252
    - Write button 251
    - XML
      - file locations 457
-



- 
- sample files 458
    - specification 449
  - Register Details Window command 249
  - Register Details Window menu command 503
  - Register display 250, 252
  - Register Name 250
  - Register Windows menu command 503
  - registers
    - changing data views of 248
    - changing values of 247
    - FPU Registers 246
    - General Registers 246
    - host-specific 246
    - Register Details window 249
    - viewing 247
    - viewing details of 249
  - Registers folder 249, 457
  - Registers menu command 503
  - Registers window 245
    - opening 247
    - opening more than one 248
  - Registry Key option
    - of Source Trees preference panel 441
  - Registry Key option, in Type pop-up menu 441
  - regular breakpoints 203
  - Regular Expression checkbox 116, 118, 122
  - Regular Expression option
    - Shielded Folders panel 430
  - regular expressions 134
    - . \* [ \_ ] Data 362
    - \ ( . \* \ ) 361
    - choosing one character from many 136
    - CVS 362
    - defined 134
    - grouping 136
    - matching any character 135, 136
    - matching simple expressions 135
    - using the find string in the replace string 136, 137
  - Relative to class field 177
  - Relaxed C popup parsing option
    - Editor Settings panel 430
  - release notes 17
  - remote connections
    - adding 382
    - changing 383
    - removing 384
  - Remote Connections preference panel 381
    - options
      - Add 382
      - Change 382
      - Remote Connection list 382
      - Remove 382
  - Remote Debugging settings panel 406
    - options
      - Launch remote host application 425
  - Remove A Set button 129
  - Remove button 390
  - Remove button, in Remove Markers window 111
  - Remove command 50
  - Remove Markers window 110
    - Cancel button 111
    - Done button 111
    - Markers list 111
    - Remove button 111
  - Remove Object Code 328
  - Remove Object Code & Compact menu
    - command 504
  - Remove Object Code menu command 504
  - Remove Toolbar Item 344
  - removing
    - build targets 50, 55
    - desktop background from behind IDE. *See* Use Multiple Document Interface, turning on.
    - files 50
    - gray background from behind IDE. *See* Use Multiple Document Interface, turning off.
    - groups 50
    - layouts 50
    - remote connections 384
    - source trees 364
    - targets 50, 55
  - Rename Breakpoint button 206
  - Rename command 52, 56
  - renaming
    - build targets 53, 56
    - files 52
-

- 
- groups 52
  - layouts 52
  - targets 52, 53, 56
  - Reopen I/O console as needed option
    - Global Settings panel 431
  - Repeated optimizations 400
  - Replace All button 118, 121
  - Replace All menu command 504
  - Replace and Find Next menu command 504
  - Replace and Find Previous command 504
  - Replace button 118, 121
  - Replace command 119
  - Replace menu command 504, 505
  - Replace With text/list box 118, 121
  - replacing
    - text in a single file 119
    - text, overview 115
  - Require Framework Style Includes 431
  - reserved access 455
  - Reset Value button 252
  - Reset Window Toolbar command in Toolbar
    - submenu 48, 505, 506
  - resetting
    - toolbars 345
  - RESETVALUE 452
  - resize bars
    - Pane 132, 190
  - Resize submenu
    - To Smallest Height command 514
    - To Smallest Width command 514
  - resizing
    - panes in an editor window 91
  - Resource File flag 396
  - Restart command 195
  - restarting
    - debugger 195
  - Restore Default Workspace option 432
  - Restore Window command (Windows) 506
  - Restrict Address Range checkbox 301
  - Result Count text box 131
  - results
    - finding problems 282
    - of multi-item search 130
    - sorting 280
  - Results pane 132
  - Resume button 189
  - Resume command 194
  - Resume menu command 506
  - resuming program execution 194
  - Retention fault 315
  - Revert button 251
  - Revert command 64
  - Revert menu command 507
  - reverting
    - files 64
    - preference panels 432
    - settings panels 432
  - revision control 445
  - routine
    - stepping into 193
    - stepping out of 193
    - stepping over 193
  - routine, selecting entirely 94
  - Run 327
  - Run button 189
  - Run command 53, 54, 194
  - Run menu command 429, 507
  - Run To Cursor menu command 507
  - running
    - a program 194
  - Runtime Settings panel 393
    - Host Application For Libraries And Code
      - Resources field 423
    - options
      - Add 394
      - Change 394
      - Environment Settings 394
      - Host Application for Libraries & Code
        - Resources 394, 423
      - Program Arguments 394, 429
      - Remove 394
      - Value 395
      - Variable 395
      - Working Directory 394, 446
    - Program Arguments field (Windows) 429
- S**
- Save a Copy As command 62
-

- 
- Save All command 61
  - Save command 61
  - Save Default Window menu command 508
  - Save open files before build option
    - Build Settings panel 432
  - Save project entries using relative paths option
    - Target Settings panel 47, 48, 432
  - Save Settings button 295, 307
  - Save This Set button 129
  - Save Workspace As menu command 508
  - Save Workspace menu command 508
  - saving
    - all files 61
    - changes done to a workspace 77
    - file copies 62
    - files 61
    - information about installed plug-ins 483
    - information about installed products 483
    - projects 35
    - workspaces 76
  - Scope Loop panel 310
  - Script Point 215, 218
  - Script Point Settings window
    - Stop in Debugger checkbox 219
  - Script Point, clearing 219
  - Script Point, setting 219
  - (Scripts) folder 501
  - Scripts option
    - Font & Tabs panel 433
  - search
    - single characters with regular expressions 136
    - using finds strings in replace strings with regular expressions 137
  - Search Cached Sub-Targets checkbox 125
  - Search Criteria text box 131
  - search engine
    - overview 25
  - Search In text/list box 123
  - Search menu 113, 473
  - Search Results window 130
    - Next Result button 132
    - Pane resize bar 132
    - Previous Result button 132
    - Result Count text box 131
    - Results pane 132
    - Search Criteria text box 131
    - setting default size and position of 508
    - Source Code pane 132
    - Source Code Pane disclosure triangle 132
    - Stop button 131
    - Warnings button 131
  - Search Selection Only checkbox 116, 119
  - Search Status column, in Access Paths panel 390
  - Search Sub-Folders checkbox 123
  - Search Up checkbox 116, 119
  - searching
    - choosing one character from many in regular expressions 136
    - grouping regular expressions 136
    - multiple files 129
    - multiple folders 123
    - multiple projects 125
    - multiple symbolics files 127
    - single characters with regular expressions 135
    - single files 117
    - using finds strings in replace strings with regular expressions 136
    - using regular expressions 134
    - with simple regular expressions 135
  - Sector Address Map pane 299
  - seeing desktop background behind IDE. *See Use Multiple Document Interface, turning off.*
  - Segments tab 50
  - Segments view 326
  - Select All menu command 508
  - Select thread window when stopping task option 433
  - Selected Item group 146
  - selecting
    - Code Completion window items 103
    - text in editor windows 93
  - selecting entire routines 94
  - selecting lines 94
  - selecting multiple lines 94
  - selecting rectangular portions of lines 94
  - Selection position option
-

- 
- Editor Settings panel 433
  - selections
    - searching (text) 134
  - Send To Back menu command 508
  - Sequential subtest 316
  - serial number, breakpoint property 209
  - Set 1, Set 2, Set 3, Set 4 374
  - Set Breakpoint menu command 508
  - Set Default Breakpoint Template button 206
  - Set Default Project command 37
  - Set Default Project menu command 509
  - Set Default Target menu command 509
  - Set Eventpoint menu command 509
  - Set Watchpoint menu command 509
  - setjmp() 275
  - setting
    - browser options 149
    - temporary 211
  - setting access breakpoint 226
  - setting default size and position of windows 508
  - setting thread-specific breakpoints 212
  - settings
    - Add 363, 390, 394, 397
    - Add Default 390
    - Always Search User Paths 389
    - Application 393
    - Apply button 387
    - Arguments 393
    - Auto-target Libraries 406
    - Cache subprojects 392
    - Cache symbolics between runs 406
    - Cancel button 387
    - Change 363, 390, 394, 397
    - Choose 363, 388
    - Clear 388
    - Compiler 396
    - Default language entry point 406
    - Details 398
    - Dump internal browse information after compile 393
    - Edit Language 397
    - Environment Settings 394
    - Export Panel button 386
    - Extension 396
    - Factory Settings button 386
    - Faster Execution Speed 398
    - File Mappings list 396
    - File Type 396
    - Flags 396
    - Host Application for Libraries & Code Resources 394
    - Host Flags 390
    - IDE window 385
    - Ignored By Make flag 396
    - Import Panel button 386
    - Initial directory 393
    - Launchable flag 396
    - Linker 388
    - Log System Messages 406
    - Name 363
    - OK button 387
    - Optimization Level slider 398
    - Output Directory 388
    - Post-linker 388
    - Precompiled File flag 396
    - Pre-linker 388
    - Program Arguments 394
    - Program entry point 406
    - Remove 363, 390, 394, 397
    - Resource File flag 396
    - Revert Panel button 386
    - Save button 387
    - Save project entries using relative paths 388
    - Smaller Code Size 398
    - Source Tree list 363
    - Stop at Watchpoints 406
    - Stop on application launch 406
    - Target Name 388
    - Target Settings Panels list 386
    - Type 363
    - Update data every *n* seconds 406
    - Use External Debugger 393
    - Use modification date caching 392
    - User specified 406
    - Value 395
    - Variable 395
    - Working Directory 394
  - settings panels
-

- 
- Access Paths 360, 389
  - Build Extras 391, 494
  - Debugger Settings 260, 405
  - File Mappings 395
  - Global Optimizations 397
  - Other Executables 402
  - Remote Debugging 406
    - reverting 432
  - Runtime Settings 393
  - Source Trees 362
  - Target Settings 387
  - setup
    - code completion 98
  - shared libraries 327
  - Shielded Folders panel
    - options
      - Find and compare operations 421
      - Project operations 429
      - Regular Expression 430
  - Shielded Folders preference panel 360
    - options
      - Add 361
      - Change 361
      - Find and compare operations 361
      - Project operations 361
      - Regular Expression 361
      - Remove 361
      - Shielded folder list 361
  - Shift Right menu command 509
  - shortcut conventions 19
  - Show all locals option
    - Display Settings panel 433
  - Show Breakpoints menu command 487, 510
  - Show Classes 162
  - Show Classes pane 165
  - Show Floating Toolbar command 497
  - Show Floating Toolbar command in Toolbar
    - submenu 510
  - Show Inherited 157
  - Show Log button 294, 314
  - Show Main Toolbar command 497
  - Show message after building up-to-date project
    - option
      - Build Settings panel 436
      - Show private 158
      - Show protected 158
      - Show public 158
      - Show tasks in separate windows option
        - Display Settings panel 436
      - Show the component palette when opening a form
        - option
          - Layout Editor panel 436
      - Show the object inspector when opening a form
        - option
          - Layout Editor panel 436
      - Show Types menu command 510
      - Show values as decimal instead of hex option
        - Display Settings panel 436
      - Show variable location option
        - Display Settings panel 436
      - Show variable types option
        - Display Settings panel 436
      - Show variable values in source code option
        - Display Settings panel 437
      - Show Window Toolbar command 497
      - Show Window Toolbar command in Toolbar
        - submenu 510
      - showing
        - classes pane 162
      - shrinking panes, in browser 161
      - Single Class Hierarchy Window 156
      - single files, searching 117
      - single-class hierarchical window
        - opening 170
      - Single-Class Hierarchy window 170
        - difference from Multi-Class Hierarchy
          - window 170
      - single-file Find and Replace window 117
      - single-file Find window 115
      - size
        - setting default for unbounded arrays 416
      - Size option
        - Font & Tabs panel 437
      - Size text box 305
      - Skip Point 215, 220
      - Skip Point, clearing 220
      - Skip Point, setting 220
      - software

- 
- development process cycle 21
  - Sort Alphabetical 161, 162
  - Sort function popup option
    - Editor Settings panel 439
  - Sort functions by method name in symbolics window option
    - Display Settings panel 437
  - Sort Hierarchical 161, 162
  - Sort Order button
    - in Files view of Project window 46
  - sorting
    - classes list 162
    - Functions list pop-up (alphabetically) 108, 109
  - sorting data 280
  - Sound Point 215, 220
  - Sound Point Settings window
    - Stop in Debugger checkbox 221
  - Sound Point, clearing 221
  - Sound Point, setting 220
  - Sound Point, Speak Message 220
  - Source box 138
  - source code
    - disabling breakpoints 210
    - disabling eventpoints 223
    - disabling special breakpoints 229
    - disabling watchpoints 227
    - editing 93
    - enabling breakpoints 210, 223
    - enabling special breakpoints 230
    - enabling watchpoints 228
    - going to a particular line 109
    - locating 107
    - setting breakpoints in 208
    - setting watchpoints in 226
    - viewing breakpoint properties 209
    - viewing eventpoint properties 223
    - viewing watchpoint properties 227
  - Source Code pane 132
  - Source Code Pane disclosure triangle 132
  - source code, navigating 107
  - source file
    - adding markers to 111
  - Source File button 191
  - source files
    - removing all markers from 112
    - removing markers from 111
  - source item, for comparison 137
  - Source list box 192
  - Source pane 142, 164, 191
    - in Symbols window 174
  - Source Pane disclosure triangle 191
  - source relative includes 439
  - source trees
    - adding 363
    - changing 364
    - removing 364
  - Source Trees panel
    - options
      - Add 363
      - Change 363
      - Choose 363
      - Name 363
      - Remove 363
      - Source Tree list 363
      - Type 363, 441
  - Source Trees preference panel 362
    - Absolute Path option 441
    - Environment Variable option 441
    - Registry Key option 441
  - Source Trees settings panel 362
  - Speak Message checkbox 217
  - special breakpoints
    - defined 229
    - purpose of 203
  - special breakpoints, disabling 229
  - special breakpoints, enabling 230
  - specialized files 329
  - Speed slider 311
  - stack 286
  - Stack Editor Windows menu command 510
  - Stack pane 190
  - stack space, finding problems 282
  - standalone application 327
  - Start text box 301, 305, 313
  - starting
    - debugger 192
  - state
-

- 
- disabled, for breakpoints 204, 225
    - disabled, for eventpoints 216
    - enabled, for breakpoints 204
    - enabled, for eventpoints 216
    - enabled, for watchpoints 225
  - static
    - icon for 163
  - stationery
    - creating for projects 38
    - creating projects 33
    - custom 38
  - Status 302, 303, 305, 310, 312, 314
  - Status area
    - in Class Browser window 157
  - status area 165
  - Step Into button 190
  - Step Into command 193
  - Step Out button 190
  - Step Out command 193
  - Step Over button 190
  - Step Over command 193
  - Step Over menu command 510
  - stepping into a routine 193
  - stepping out of a routine 193
  - stepping over a routine 193
  - Stop At End Of File checkbox 116, 119
  - Stop at Watchpoints option
    - Debugger Settings panel 437
  - Stop Build menu command 511
  - Stop button 121, 131, 189
  - Stop command 194, 511
  - Stop in Debugger checkbox 217, 219, 221
  - Stop On Application Launch option
    - Debugger Settings panel 437
  - stopping program execution 194
  - Straight Line 169
  - strategies
    - for build targets 40
    - for projects 40
    - for subprojects 41
  - Strength Reduction 400
  - Strings option
    - Text Colors panel 438
  - structure
    - of documentation 18
  - submenus
    - Align 483, 485
  - subproject, defined 39
  - subprojects
    - creating 39
    - opening 40
    - strategies for 41
  - Success option
    - Build Settings panel 439
  - summary data 273
  - summation, of two variables 237
  - Switch To Monitor menu command 511
  - symbol definitions 112
  - symbol definitions, looking up 112
  - Symbol hint 195
  - symbol hint
    - toggling 195
    - turning off 195
    - turning on 195
    - using 196
  - symbol implementations
    - viewing all 174
  - symbol-editing shortcuts 96
  - Symbolics button 190
  - symbolics file, defined 188
  - symbolics files
    - choosing a debugger for 383
    - searching (multiple) 127
  - Symbolics list 127
  - Symbolics list box 127
  - Symbolics menu command 511
  - Symbolics option
    - IDE Extras panel 440
  - Symbolics window 255
    - opening 256
    - using the Executables pane 257
    - using the Files pane 257
    - using the Functions pane 257
  - Symbolics Window menu command 511
  - symbols
    - shortcuts for editing 96
    - viewing all implementations 174
  - Symbols list
-

- 
- in Browser Contents window 171
  - Symbols pane 174
  - Symbols pop-up 171
  - Symbols window 172
    - Source pane 174
    - Symbols pane 174
    - toolbar 174
  - symbols window 174
  - Synchronize Modification Dates 328
  - Synchronize Modification Dates command 49
  - Synchronize Modification Dates menu
    - command 511
  - Synchronize Modification Dates toolbar
    - button 44
  - System Headers checkbox 125
  - System Paths list
    - Recursive Search column 391
    - Search Status column 390
  - System Paths option
    - Access Paths panel 440
- T**
- Tab indents selection option
    - Font & Tabs panel 440
  - Tab Inserts Spaces option
    - Font & Tabs panel 440
  - Tab Size option
    - Font & Tabs panel 440
  - tabs
    - Groups 206
    - In Files 122
    - In Folders 122
    - In Projects 122
    - In Symbolics 122
    - Instances 206
    - Templates 206
  - Target Address text box 309, 311
  - Target column
    - in Files view of Project window 46
  - Target Configuration panel 295
  - Target list box 125
  - target management 50
  - Target Memory Buffer Address text box 296
  - Target Memory Buffer Size text box 297
  - Target Name option
    - Target Settings panel 440
  - Target Processor text/list box 296, 308
  - Target Scratch Memory End text box 314
  - Target Scratch Memory Start text box 314
  - target settings
    - Add 363, 390, 394, 397
    - Add Default 390
    - Always Search User Paths 389
    - Application 393
    - Apply button 387
    - Arguments 393
    - Auto-target Libraries 406
    - Cache subprojects 392
    - Cache symbolics between runs 406
    - Cancel button 387
    - Change 363, 390, 394, 397
    - Choose 363, 388
    - Clear 388
    - Compiler 396
    - Default language entry point 406
    - Details 398
    - Dump internal browse information after
      - compile 393
    - Edit Language 397
    - Environment Settings 394
    - Export Panel button 386
    - Extension 396
    - Factory Settings button 386
    - Faster Execution Speed 398
    - File Mappings list 396
    - File Type 396
    - Flags 396
      - for IDE 385
    - Host Application for Libraries & Code
      - Resources 394
    - Host Flags 390
    - Ignored By Make flag 396
    - Import Panel button 386
    - Initial directory 393
    - Launchable flag 396
    - Linker 388
    - Log System Messages 406
    - Name 363
-



- 
- OK button 387
  - Optimization Level slider 398
  - Output Directory 388
  - Post-linker 388
  - Precompiled File flag 396
  - Pre-linker 388
  - Program Arguments 394
  - Program entry point 406
  - Remove 363, 390, 394, 397
  - Resource File flag 396
  - Revert Panel button 386
  - Save button 387
  - Save project entries using relative paths 388
  - Smaller Code Size 398
  - Source Tree list 363
  - Source Trees 362
  - Stop at Watchpoints 406
  - Stop on application launch 406
  - Target Name 388
  - Target Settings Panels list 386
  - Type 363
  - Update data every  $n$  seconds 406
  - Use External Debugger 393
  - Use modification date caching 392
  - User specified 406
  - Value 395
  - Variable 395
  - Working Directory 394
  - Target Settings command 511
  - Target Settings Panel 330
  - Target Settings panel 56, 387
    - options
      - Choose 388
      - Clear 388
      - Linker 388, 426
      - Output Directory 388, 428
      - Post-linker 388, 429
      - Pre-linker 388, 429
      - Save project entries using relative paths 47, 48, 388, 432
      - Target Name 388, 440
  - target settings panels
    - Access Paths 389
    - Build Extras 391, 494
    - Debugger Settings 260, 405
    - File Mappings 395
    - Global Optimizations 397
    - Other Executables 402
    - Remote Debugging 406
    - Runtime Settings 393
    - Target Settings 387
  - Target Settings Panels list 386
  - Target Settings toolbar button 44
  - Target Settings window 385
    - Apply button 387
    - Cancel button 387
    - Export Panel button 386
    - Factory Settings button 386
    - Import Panel button 386
    - OK button 387
    - opening 387
    - Revert Panel button 386
    - Save button 387
    - Target Settings Panels list 386
  - targeting 330
  - targets 31
    - configuring 56
    - creating 55
    - files 50
    - managing 54
    - moving 52
    - removing 50, 55
    - renaming 52, 53, 56
    - setting default 56
    - strategies for 40
  - Targets page 49
  - Targets tab 56
  - Targets view 36, 52, 55
  - tasks
    - activating automatic code completion 98
    - adding a constant to a variable 237
    - adding a keyword to a keyword set 401
    - adding an executable file 403
    - adding expressions (Expressions window) 236
    - adding markers to a source file 111
    - adding panes to an editor window 91
    - adding remote connections 382
-

- 
- adding source trees 363
  - adding subprojects to a project 39
  - alphabetizing Functions list pop-up order 108, 109
  - applying file differences 143
  - attaching the debugger to a process 260
  - balancing punctuation 96
  - changing an executable file 404
  - changing line views in a hierarchical window 169
  - changing register data views 248
  - changing register values 247
  - changing remote connections 383
  - changing source trees 364
  - changing the find string 133
  - choosing a default project 37
  - choosing files to compare 139
  - choosing folders to compare 140
  - clearing a breakpoint 211
  - clearing a Log Point 217
  - clearing a Pause Point 218
  - clearing a Script Point 219
  - clearing a Skip Point 220
  - clearing a Sound Point 221
  - clearing a Trace Collection Off eventpoint 222
  - clearing a Trace Collection On eventpoint 222
  - clearing a watchpoint 228
  - clearing all breakpoints 211
  - clearing all watchpoints 228
  - closing a docked window 73
  - closing a workspace 77
  - closing projects 38
  - collapsing a docked window 72
  - collapsing browser panes 161
  - collapsing the editor window toolbar 88
  - completing code for data members 103
  - completing code for parameter lists 104
  - creating a breakpoint template 213
  - creating a new class 162, 175, 176
  - creating a new data member 164, 181, 182
  - creating a new member function 163, 179, 180
  - creating custom project stationery 38
  - creating empty projects 34
  - creating new projects from makefiles 33
  - creating new projects using project stationery 33
  - deactivating automatic code completion 99
  - deleting a breakpoint template 214
  - disabling a breakpoint 210
  - disabling a watchpoint 227
  - disabling an eventpoint 223
  - docking a window by using a contextual menu 68
  - docking a window by using drag and drop 69
  - docking windows of the same kind 69
  - enabling a breakpoint 210, 223
  - enabling a watchpoint 228
  - examining items in the Folder Compare Results window 146
  - expanding a docked window 73
  - expanding browser panes 160
  - expanding the editor window toolbar 88
  - exporting projects to XML files 37
  - floating a window 71
  - for managing files 59
  - generating project link maps 330
  - going to a particular line 109
  - hiding the classes pane 162
  - importing projects saved as XML files 37
  - indenting text blocks 95
  - issuing command lines 321
  - killing program execution 194
  - looking up symbol definitions 112
  - making a summation of two variables 237
  - making a window an MDI child 71
  - manipulating variable formats 234
  - moving a docked window 73
  - navigating browser data 152
  - navigating Code Completion window 102
  - navigating to a marker 111
  - opening a recent workspace 77
  - opening a single-class hierarchical window 170
  - opening a workspace 77
-

- 
- opening an Array window 245
  - opening projects 35
  - opening projects created on other hosts 35
  - opening registers in a separate Registers window 248
  - opening subprojects 40
  - opening the Breakpoints window 207
  - opening the Cache window 318
  - opening the Command window 320
  - opening the Expressions window 236
  - opening the Flash Programmer window 293
  - opening the Global Variables window 232
  - opening the Hardware Diagnostics window 306
  - opening the Log window 261
  - opening the Processes window 258, 259
  - opening the Profile window 319
  - opening the Registers window 247
  - opening the Symbolics window 256
  - opening the symbols window 174
  - opening the Target Settings window 387
  - opening the Trace window 317
  - overstriking text (Windows) 95
  - printing class hierarchies 169
  - printing projects 36
  - removing a keyword from a keyword set 402
  - removing a marker from a source file 111
  - removing all markers from a source file 112
  - removing an executable file 405
  - removing panes from an editor window 91
  - removing remote connections 384
  - removing source trees 364
  - replacing text in a single file 119
  - resizing panes in an editor window 91
  - restarting the debugger 195
  - resuming program execution 194
  - running a program 194
  - saving a workspace 76
  - saving changes to a workspace 77
  - saving projects 35
  - saving the contents of the Breakpoints window 208
  - searching a single file 117
  - searching for text across multiple files 129
  - searching for text across multiple folders 123
  - searching for text across multiple projects 125
  - searching for text across multiple symbolics files 127
  - searching with a text selection 134
  - selecting entire routines 94
  - selecting item in Code Completion window 103
  - selecting lines 94
  - selecting multiple lines 94
  - selecting rectangular portions of lines 94
  - selecting text in editor windows 93
  - setting a breakpoint 208
  - setting a conditional breakpoint 211
  - setting a conditional eventpoint 224
  - setting a conditional watchpoint 228
  - setting a Log Point 216
  - setting a Pause Point 218
  - setting a Script Point 219
  - setting a Skip Point 220
  - setting a Sound Point 220
  - setting a temporary breakpoint 211
  - setting a Trace Collection Off eventpoint 221
  - setting a Trace Collection On eventpoint 222
  - setting a watchpoint 226
  - showing the classes pane 162
  - sorting the classes list 162
  - specifying the default breakpoint template 214
  - starting the debugger 192
  - stepping into a routine 193
  - stepping out of a routine 193
  - stepping over a routine 193
  - stopping program execution 194
  - suppressing dockable windows 72
  - toggling automatic punctuation balancing 97
  - toggling the symbol hint 195
  - triggering code completion by keyboard 99
-

- 
- triggering code completion from IDE menu bar 98
  - unapplying file differences 143
  - undocking a window 70
  - unfloating a window 71
  - unindenting text blocks 95
  - using contextual menus 197
  - using the default workspace 76
  - using the document settings pop-up 89
  - using the Executables pane in the Symbolics window 257
  - using the Files pane in the Symbolics window 257
  - using the Find Next command 132
  - using the Find Previous command 133
  - using the Functions list pop-up 108
  - using the Functions pane in the Symbolics window 257
  - using the Interfaces list pop-up 108
  - using the symbol hint 196
  - using the VCS pop-up 89
  - using virtual space 95
  - viewing a file path 47
  - viewing breakpoint properties 209
  - viewing browser data by contents 172
  - viewing browser data by inheritance 168
  - viewing class data from hierarchy windows 160
  - viewing eventpoint properties 223
  - viewing global variables for different processes 232
  - viewing registers 247
  - viewing watchpoint properties 227
  - template, default for breakpoints 213
  - template, for breakpoints 213
  - Templates option 374
  - Templates tab 206
  - templates, creating for breakpoints 213
  - templates, deleting for breakpoints 214
  - templates, specifying the default for breakpoints 214
  - temporary breakpoint, defined 211
  - temporary breakpoints 204
  - text
    - changing a find string 133
    - find by selecting 132
    - finding 115
    - overstriking (Windows) 95
    - replacing 115
    - searching with a selection 134
  - text blocks, indenting 95
  - text blocks, unindenting 95
  - text boxes
    - Address 250
    - Bit Value 251
    - Description File 250, 252
    - End 301, 313
    - Flash Memory Base Address 298
    - Message 217
    - Offset 301
    - Passes 314
    - Result Count 131
    - Search Criteria 131
    - Size 305
    - Start 301, 305, 313
    - Target Address 309, 311
    - Target Memory Buffer Address 296
    - Target Memory Buffer Size 297
    - Target Scratch Memory End 314
    - Target Scratch Memory Start 314
    - Use Selected File 300
    - Use Target Initialization 296, 308
    - Value to Write 309, 311
  - Text Colors panel
    - options
      - Activate Browser Coloring 422
      - Activate Syntax Coloring 422, 425, 438
      - Foreground 422
      - Keywords 425
      - Strings 438
  - Text Colors preference panel
    - options
      - Activate Browser Coloring 374
      - Activate Syntax Coloring 374
      - Background 373
      - Classes 374
      - Comments 374
      - Constants 374
-

- 
- Edit 374
    - Enums 374
    - Foreground 373
    - Functions 374
    - Globals 374
    - Keywords 374
    - Macros 374
    - Other 375
    - Set 1, Set 2, Set 3, Set 4 374
    - Strings 374
    - Templates 374
    - TypeDefs 375
  - text editing area, in editor window 90
  - Text View list box 252, 253
    - Auto 253
  - Text View pop-up menu
    - Bitfield Description option 253
    - Register Description option 253
    - Register Details option 253
  - text/list boxes
    - By Type 123
    - Find 116, 118, 121
    - Replace With 118, 121
    - Search in 123
    - Target Processor 296, 308
  - text-selection Find 132
  - THINK Reference 422
  - third-party editor support 444
  - third-party text editors
    - Emacs 425
  - Thread window
    - Breakpoints button 190
    - current-statement arrow 191
    - dash 191
    - debug button 189
    - Expressions button 190
    - Functions list box 191
    - Kill button 189
    - Line And Column button 192
    - Pane Collapse box 190
    - Pane Expand box 190
    - Pane resize bar 190
    - Resume button 189
    - run button 189
    - Source File button 191
    - Source list box 192
    - Source pane 191
    - Source Pane disclosure triangle 191
    - Stack pane 190
    - Step Into button 190
    - Step Out button 190
    - Step Over button 190
    - Stop button 189
    - Symbolics button 190
    - Variables pane 190
    - Variables Pane Listing button 191
  - thread window 188
  - thread, breakpoint property 210
  - threading in IDE 415
  - thread-specific breakpoints 212
    - \_\_throw() 485
  - ticksTimeBase 273, 279, 287
  - Tile Editor Windows command 512
  - Tile Editor Windows Vertically command 512
  - Tile Horizontally command 512
  - Tile Vertically command 512
  - time hogs, finding 282
  - timebase 273, 287
  - timeMgrTimeBase 274, 287
  - times left, breakpoint property 210
  - To Smallest Height command in Resize
    - submenu 514
  - To Smallest Width command in Resize
    - submenu 514
  - tooggling
    - symbol hint 195
  - toolbar
    - collapsing in editor window 88
    - expanding in editor window 88
  - Toolbar (Editor Window) Elements
    - Document Settings 343
    - File Dirty Indicator 343
    - File Path field 343
    - Functions 343
    - Header Files 343
    - Markers 343
    - Version Control Menus 343
  - toolbar buttons
-

- 
- Browser Contents 156
  - Class Hierarchy 156
  - Go Back 156
  - Go Forward 156
  - Make 44
  - Single Class Hierarchy Window 156
  - Synchronize Modification Dates 44
  - Target Settings 44
  - Toolbar Items 333, 343
  - Toolbar submenu
    - Anchor Floating Toolbar command 484
    - Clear Floating Toolbar command 487
    - Clear Main Toolbar command 488
    - Clear Window Toolbar command 488
    - Hide Floating Toolbar command 497
    - Hide Main Toolbar command 497
    - Reset Window Toolbar command 48, 505, 506
    - Show Floating Toolbar command 497, 510
    - Show Main Toolbar command 497
    - Show Window Toolbar command 510
  - Toolbars
    - Add element 342, 343
    - Clear Elements 344
    - Customize 341
    - Elements 341, 342
    - Icons 343
    - Instances of 342
    - Main (floating) 342
    - Modify 342
    - Project and Window 342
    - Remove single element 342
    - Toolbar Items tab 342
    - Types 341
  - toolbars
    - editor 88
    - for Symbols window 174
    - resetting 345
  - tools 327
    - browser 25
    - build system 26
    - debugger 26
    - editor 25
    - project manager 25
      - search engine 25
    - tools, for hardware 293
  - ToolServer menu 444
  - ToolServer Worksheet command 514
  - ToolTip 343
  - touch
    - defined 46
  - Touch column 53, 54
    - in Files view of Project window 46
  - Touch command 53
  - touching
    - all files 53
    - all groups 53
    - files 53
    - groups 53
  - Trace Collection Off 221
  - Trace Collection Off eventpoint 216
  - Trace Collection Off eventpoint, clearing 222
  - Trace Collection Off eventpoint, setting 221
  - Trace Collection On 222
  - Trace Collection On eventpoint 216
  - Trace Collection On eventpoint, clearing 222
  - Trace Collection On eventpoint, setting 222
  - Trace window 317
    - opening 317
  - Treat as Expression checkbox 217
  - triggering
    - code completion by keyboard 99
    - code completion from IDE menu bar 98
  - turning off
    - symbol hint 195
  - turning on
    - symbol hint 195
  - Type list box
    - Absolute Path option 441
  - Type option
    - Source Trees panel 441
  - Type pop-up menu
    - Environment Variable option 441
    - Registry Key option 441
  - type, breakpoint property 209
  - TypeDefs option 375
  - types
    - of documentation 18
-

## U

- Unanchor Floating Toolbar command 514
- Unapply button 142
- Unapply Difference command 143, 514
- unbounded arrays, setting default size for viewing 416
- Uncaught Exceptions Only command 515
- Undo button 142
- Undo command 515
- unlocking windows 70
- unfloating windows 71
- Ungroup command 515
- unindenting text blocks 95
- Untouch command 54
- untouching
  - a file 54
  - a group 54
  - all files 54
  - all groups 54
- Update Data Every n Seconds option 441
- Use "not found" dialog option 443
- Use Concurrent Compiles option 430, 441
- Use Custom Settings checkbox 296, 308
- Use External Debugger option 441
- Use External Editor option 441
- Use Local Project Data Storage option 442
- Use modification date caching option 442
- Use Multiple Document Interface option 65, 443
  - turning off 357
  - turning on 357
- Use multiple undo option 515
  - in Editor Settings panel 443
- Use Run to Cursor command 211
- Use Script menu option 443
- Use Selected File checkbox 300
- Use Selected File text box 300
- Use Target CPU checkbox 314
- Use Target Initialization checkbox 296, 308
- Use Target Initialization text box 296, 308
- Use Third Party Editor option 444
- Use ToolServer menu option
  - IDE Extras panel 444
- User Paths list
  - Recursive Search column 391

- Search Status column 390
- User Paths option 445
- User Specified option 445
- User specified option 406
- using
  - document settings pop-up 89
  - Executables pane in the Symbolics window 257
  - Files pane in the Symbolics window 257
  - Find Next command 132
  - Find Previous command 133
  - Functions list pop-up 108
  - Functions pane in the Symbolics window 257
  - Interfaces list pop-up 108
  - Register Details window 252
  - symbol hint 196
  - VCS pop-up 89
  - virtual space 95

## V

- VALUE 457
- Value to Write text box 309, 311
- variable formatting 234
- Variable Values Change option
  - Display Settings panel 445
- Variable window 233
- variables
  - `^var` placeholder 235
  - adding a constant to 237
  - making a summation of 237
  - manipulating formats 234
  - symbol hint 195
- Variables pane 190
- Variables Pane Listing button 191
- variables, working with 231
- VCS 89
  - list pop-up 158
  - pop-up 89
- VCS Commands option
  - Editor Settings panel 445
- VCS menu 165, 445
- VCS pop-up
  - using 89

---

- Vectorization 400
- Verify button 302
- version control 445
- Version Control Settings command 515
- Version Control System. *See* VCS.
- Vertical Center command in Align submenu 507, 513, 514, 515
- view
  - Class 281, 282
  - Detail 280
  - Flat 280
  - Link Order 326
  - Object 282
  - Overlays 326
  - Segments 326
- View Array menu command 515
- View as implementor 158
- View as subclass 158
- View As Unsigned Decimal menu command 515, 516, 517
- View as user 158
- View Disassembly menu command 517
- view in profiler
  - detail 280
- View Memory As command 517
- View Memory command 517
- View Mixed menu command 517
- View Source menu command 518
- View Target Memory Writes checkbox 297
- View Variable menu command 518
- viewing
  - all symbol implementations 174
  - breakpoints 207
  - browser data by contents 172
  - browser data by inheritance 168
  - file paths 47
  - register details 249
  - registers 247
- viewing access breakpoint 227
- viewing installed plug-ins 483
- viewing installed products 483
- virtual
  - icon for 163
- virtual space, using 95

## W

- Walking 1's checkbox 313
- Walking Ones subtest 315
- Walking Ones test
  - Address Line fault 315
  - Data Line fault 315
  - Retention fault 315
  - subtests
    - Ones Retention 315
    - Walking Ones 315
    - Walking Zeros 315
    - Zeros Retention 315
- Walking Zeros subtest 315
- Warnings button 131
- Watchpoint Indicator option
  - Display Settings panel 446
- watchpoints
  - access breakpoint 225
  - clearing all 228
  - defined 225
  - enabled 225
  - purpose of 203
  - setting conditional 228
- watchpoints, clearing 228
- watchpoints, disabling 227
- watchpoints, enabling 228
- watchpoints, setting 226
- watchpoints, viewing properties for 227
- what is
  - a debugger 187
  - a symbolics file 188
- When Debugging Starts: Do Nothing option 446
- win32TimeBase 274, 287
- window
  - Customize IDE Commands 346
  - Profiler 278
- Window Follows Insertion Point option 446
- Window menu 472, 481
  - Restore Window command (Windows) 506
- Window position and size option
  - Editor Settings panel 446
- Window Settings preference panel 378
  - options
    - Close non-debugging windows 379

---



- 
- Collapse non-debugging windows 379
    - Do nothing 379
    - Do nothing to project windows 379
    - Hide non-debugging windows 379
    - Minimize non-debugging windows 379
  - window types
    - docked 66
    - floating 66
    - MDI child 66
  - Windowing panel
    - options
      - Hide non-debugging windows 423
      - Minimize non-debugging windows 427
  - Windows
    - creating files 59
  - windows 204
    - Array 243
    - Browser Contents 171
    - Cache 318
    - Class Browser 155
    - Code Completion 100
    - Command 320
    - Compare Files Setup 138
    - Customize IDE Commands 133
    - dock bars in dockable windows 72
    - dockable 65
    - dockable, about 65
    - dockable, turning off 72
    - dockable, working with 68
    - docking the same kind of 69
    - docking with a contextual menu 68
    - docking with drag and drop 69
    - editor 85
    - editor, other 90
    - Expressions 235
    - File Compare Results 141
    - Find (single-file) 115
    - Find and Replace (multiple-file) 120
    - Find and Replace (single-file) 117
    - Flash Programmer 293
    - floating 71
    - Folder Compare Results 144
    - Global Variables 231
    - Hardware Diagnostics 306
    - hierarchy 168
    - IDE Preferences 227, 351
    - Log 260
    - making MDI children of 71
    - Memory 239
    - New C++ Class 176
    - New C++ Data Member 183
    - New C++ Member Function 180
    - Processes 258
    - project window 43
    - Registers 245
    - remembering size and position of 508
    - Remove Markers 110
    - saving default size and position of 508
    - Search results 130
    - Symbolics 255
    - Target Settings 385
    - Trace 317
    - undocking 70
    - unfloating 71
    - variable 233
  - Windows menu layout 469
  - WinHelp (Windows) 112
  - Wizards
    - Browser 175
  - wizards
    - New Class 162, 175, 176
    - New Data Member 164, 181, 182
    - New Member Function 179, 180
    - New Member Functions 163
  - Word option button 309, 311, 314
  - working
    - with IDE preferences 351
    - with IDE target settings 385
  - Working Directory option
    - Runtime Settings panel 446
  - working with 68
    - browser 149
    - class browser windows 155
    - class hierarchy windows 167
    - IDE hardware tools 293
  - working with breakpoint templates 213
    - Auto Breakpoint template 213
    - Hardware Breakpoint template 213
-

- 
- Software Breakpoint template 213
  - working with breakpoints 208
  - working with debugger data 255
  - working with dockable windows 68
  - working with eventpoints 223
  - working with files 59
  - working with memory 239
  - working with projects 29
  - working with variables 231
  - workspace, defined 75
  - workspaces 75
    - closing 77
    - opening 77
    - opening recent 77
    - saving 76
    - saving changes 77
    - using default 76
  - Workspaces option
    - IDE Extras panel 446
  - workspaces, about 75
  - write access 454
  - Write button 251
  - Write option button 309, 311

## **X**

### **XML**

- exporting projects 37
- importing projects 37
- parsing 449
- references 466
- Register Details Window
  - BFVALUE 456
  - BITFIELD 453
  - file locations 457
  - REGISTER 451
  - sample files 458
- Register Details window
  - specification 449
- XML file
  - creating 458

## **Z**

- Zeros Retention subtest 315
- Zoom Window menu command 518