

# FS23\_PB

## Safety system basis chip (SBC) with power management, CAN FD and LIN transceivers

Rev. 3.0 — 26 February 2024

Product brief



## 1 General description

---

The FS23 system basis chip (SBC) offers an expandable family of devices that is pin-to-pin and software compatible. The FS23 SBC is scalable from the linear voltage regulator version to the DC-DC regulator version, as well as from QM to ASIL B. The FS23 SBC includes CAN and LIN transceivers, along with a number of system and safety features for the latest generation of automotive electronic control units (ECU).

The FS23 SBC provides a high level of integration in order to optimize the bill of material (BOM) cost for the body and comfort market.

The FS23 device is highly flexible. It is suitable for S32K processor-based applications, as well as multivendor processors because of its high level of flexibility.

Several device versions are available, offering choice in output-voltage settings, operating frequency, power-up sequencing, and inputs/outputs configuration to address multiple applications.



Safety system basis chip (SBC) with power management, CAN FD and LIN transceivers

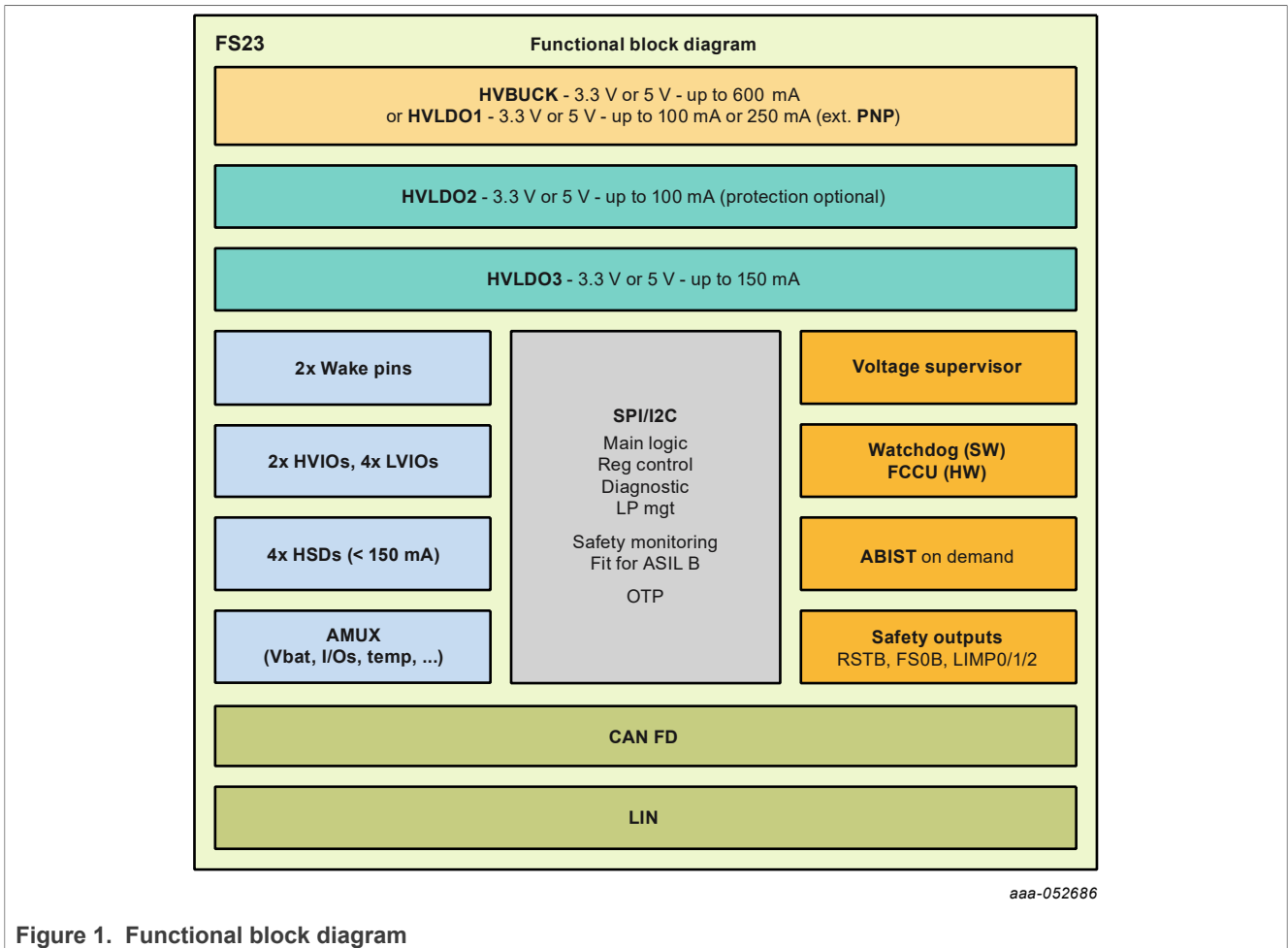

Figure 1. Functional block diagram

## 2 Features and benefits

### Operating modes

- Normal mode with all power management and functional safety features available
- Stop mode: Low-power OFF mode with multiple wake-up sources (LPOFF)
- Standby mode: Low-power ON mode with HVBUCK or HVLDO1 active and multiple wake-up sources (LPON)

### Power management

- HVBUCK: Synchronous buck converter with integrated FETs. Configurable Normal mode output voltage and LPON mode output voltage (3.3 V or 5.5 V). Output DC current capability of 600 mA in Normal mode, and 100 mA current capability in Low-power ON mode
- HVLDO1: High-voltage LDO instead of the HVBUCK for MCU supply with selectable output voltage (3.3 V or 5.5 V) and up to 100 mA DC current capability with internal PMOS and 250 mA with external PNP
- HVLDO2: High-voltage LDO regulator for system loads, with optional external protection for off-board sensors, selectable output voltage (3.3 V or 5.0 V) and up to 100 mA DC current capability
- HVLDO3: High-voltage LDO regulator for CAN FD block supply or other with selectable output voltage (3.3 V or 5.0 V) and up to 150 mA current capability

### System features

- One CAN FD supporting up to 5 Mbps communication following ISO 11898-2:2016 and SAE J2284 standards
- One LIN following LIN 2.2, ISO 17987-4 and SAE-J2602-2 standards
- Two wake-up inputs (40 V capable)
- Two high-voltage I/Os with wake-up capability (40 V capable)
- Up to four low-voltage I/Os with wake-up capability
- Four configurable high-side drivers with 150 mA drive capability, to supply LEDs or enable external devices (INH), and cyclic-sense capability
- Multiple wake-up sources: WAKE pins, HVIO pins, LVIO pins, CAN FD, LIN or dedicated SPI / I<sup>2</sup>C command
- Device control via 32 bits SPI interface or via I<sup>2</sup>C interface, with CRC
- Integrated long duration timer (LDT) for system shutdown and wake-up control, programmable up to 194 days
- 16-channel analog multiplexer (AMUX) for system monitoring (temperature, battery voltage, internal voltages)

### Functional safety

- Developed following ISO 26262:2018 standard to fit for ASIL B applications
- Internal monitoring circuitry with its own reference
- Additional input for external voltage monitoring
- Window or timeout watchdog function to monitor the MCU failures by software
- FCCU inputs to monitor MCU failures by hardware
- Analog built-in self-test (ABIST) on demand
- Safety outputs (RSTB, FSOB, LIMP0 and LIMP1/2 with 1.25 Hz or 100 Hz PWM capability)

### EMC compliance

- The FS23 EMC tests are performed according to ZVEI Generic IC EMC Test Specification version 2.1 (2017) and FMC1278 Electromagnetic Compatibility Specification for Electrical/Electronic Components and subsystems version 3.0 (2018).
- CAN EMC performances certified against IEC62228-3:2019 and SAE J2962-2:2019
- LIN EMC performances certified against IEC62228-2:2016 and SAE J2962-1:2019

### Configuration and enablement

- QFN48EP: QFN 48 pins with exposed pad for optimized thermal management, wettable flanks, 7 x 7 x 0.85 mm, 0.5 mm pitch, 48 pins
- One-time programmable (OTP) memory for scalability, expandability and device customization
- OTP emulation mode for system development and evaluation

### 3 Applications

---

- Body control module
- HVAC
- Lighting
- Steering column lock
- Seat module
- Roof module
- Door control module
- Car access
- Gearshift
- Seat belt pre-tension
- Tail gate
- Alarm

## 4 Ordering information

This section describes the part numbers available to be purchased, along with their main differences. It also describes how the part number reference is built.

### 4.1 Part numbers definition

Two FS23 part numbering types can be found: a full part number reference and a simplified part number.

Figure 2 and Figure 3 describe how the FS23 part numbers are built.

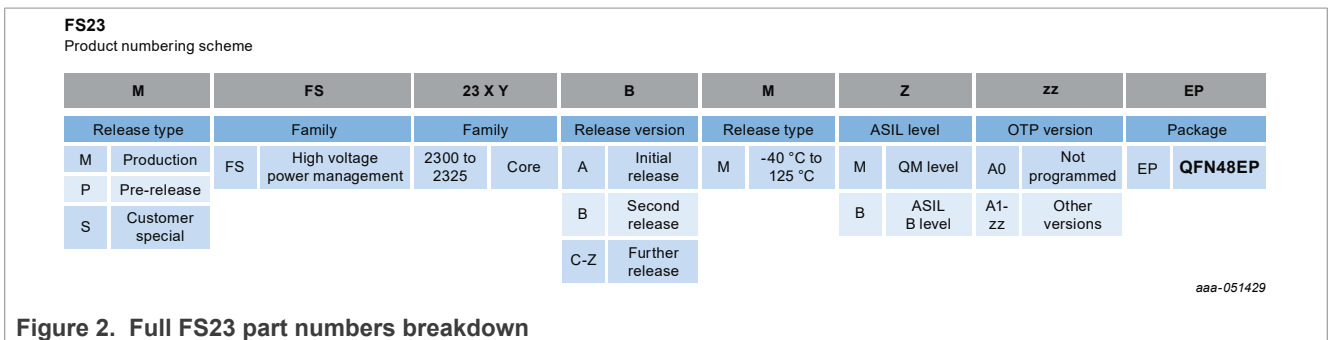

Figure 2. Full FS23 part numbers breakdown

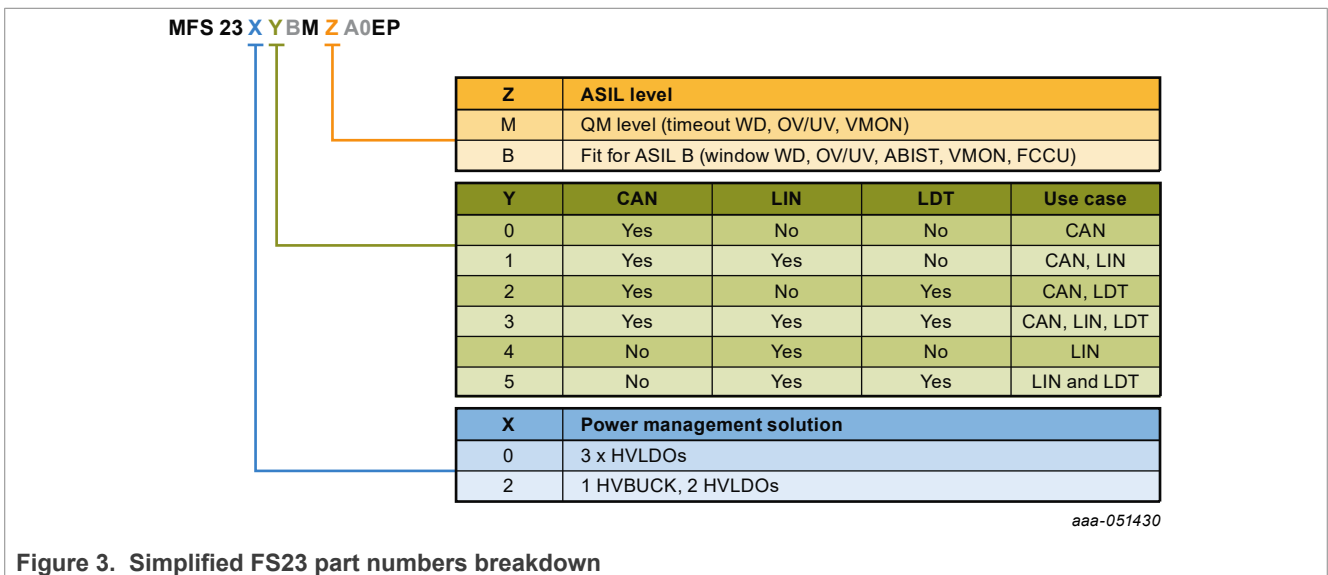

Figure 3. Simplified FS23 part numbers breakdown

Figure 4 maps FS23 part numbers versus the selectable product features.

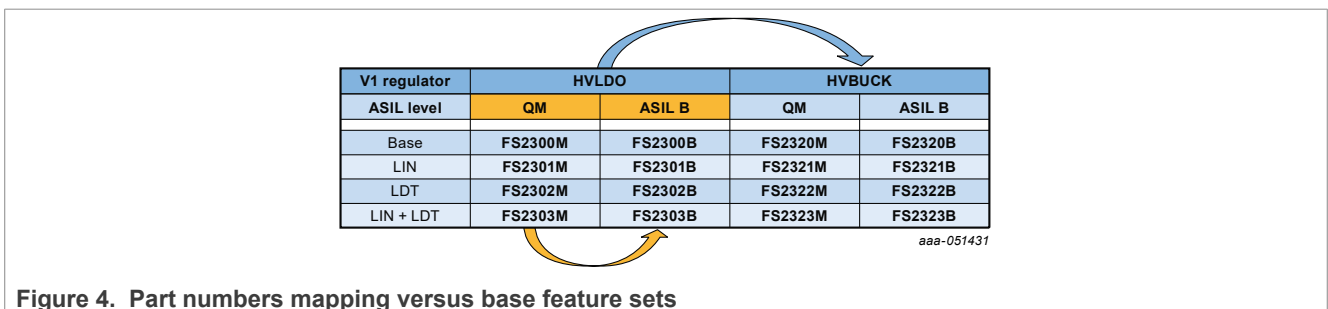

Figure 4. Part numbers mapping versus base feature sets

## 4.2 Part numbers list

Table 1. Device segmentation

Generic part number	V1 type	HV LDO2	HV LDO3	CAN	LIN	LDT	SPI / I <sup>2</sup> C	AMUX	HVIOs	LVIOs	Wake pins	High-side drivers	Fit for ASIL	FS0B	LIMPx	VMON_EXT	FCCU	Watchdog	Cyclic CRC check	RSTB 8 s timer	ABIST on demand
FS2300M	HVLDO	Yes	Yes	Yes	No	No	Yes	Yes	Yes	Yes	Yes	Yes	QM	No	Opt	No	No	Opt.	Opt.	No	No
FS2301M	HVLDO	Yes	Yes	Yes	Yes	No	Yes	Yes	Yes	Yes	Yes	Yes	QM	No	Opt	No	No	Opt.	Opt.	No	No
FS2302M	HVLDO	Yes	Yes	Yes	No	Yes	Yes	Yes	Yes	Yes	Yes	Yes	QM	No	Opt	No	No	Opt.	Opt.	No	No
FS2303M	HVLDO	Yes	Yes	Yes	Yes	Yes	Yes	Yes	Yes	Yes	Yes	Yes	QM	No	Opt	No	No	Opt.	Opt.	No	No
FS2304M	HVLDO	Yes	Yes	No	Yes	No	Yes	Yes	Yes	Yes	Yes	Yes	QM	No	Opt	No	No	Opt.	Opt.	No	No
FS2305M	HVLDO	Yes	Yes	No	Yes	Yes	Yes	Yes	Yes	Yes	Yes	Yes	QM	No	Opt	No	No	Opt.	Opt.	No	No
FS2300B	HVLDO	Yes	Yes	Yes	No	No	Yes	Yes	Yes	Yes	Yes	Yes	ASIL B	Yes	Opt	Yes	Yes	Yes	Yes	Yes	Yes
FS2301B	HVLDO	Yes	Yes	Yes	Yes	No	Yes	Yes	Yes	Yes	Yes	Yes	ASIL B	Yes	Opt	Yes	Yes	Yes	Yes	Yes	Yes
FS2302B	HVLDO	Yes	Yes	Yes	No	Yes	Yes	Yes	Yes	Yes	Yes	Yes	ASIL B	Yes	Opt	Yes	Yes	Yes	Yes	Yes	Yes
FS2303B	HVLDO	Yes	Yes	Yes	Yes	Yes	Yes	Yes	Yes	Yes	Yes	Yes	ASIL B	Yes	Opt	Yes	Yes	Yes	Yes	Yes	Yes
FS2304B	HVLDO	Yes	Yes	No	Yes	No	Yes	Yes	Yes	Yes	Yes	Yes	ASIL B	Yes	Opt	Yes	Yes	Yes	Yes	Yes	Yes
FS2305B	HVLDO	Yes	Yes	No	Yes	Yes	Yes	Yes	Yes	Yes	Yes	Yes	ASIL B	Yes	Opt	Yes	Yes	Yes	Yes	Yes	Yes
FS2320M	HVBUCK	Yes	Yes	Yes	No	No	Yes	Yes	Yes	Yes	Yes	Yes	QM	No	Opt	No	No	Opt.	Opt.	No	No
FS2321M	HVBUCK	Yes	Yes	Yes	Yes	No	Yes	Yes	Yes	Yes	Yes	Yes	QM	No	Opt	No	No	Opt.	Opt.	No	No
FS2322M	HVBUCK	Yes	Yes	Yes	No	Yes	Yes	Yes	Yes	Yes	Yes	Yes	QM	No	Opt	No	No	Opt.	Opt.	No	No
FS2323M	HVBUCK	Yes	Yes	Yes	Yes	Yes	Yes	Yes	Yes	Yes	Yes	Yes	QM	No	Opt	No	No	Opt.	Opt.	No	No
FS2324M	HVBUCK	Yes	Yes	No	Yes	No	Yes	Yes	Yes	Yes	Yes	Yes	QM	No	Opt	No	No	Opt.	Opt.	No	No
FS2325M	HVBUCK	Yes	Yes	No	Yes	Yes	Yes	Yes	Yes	Yes	Yes	Yes	QM	No	Opt	No	No	Opt.	Opt.	No	No
FS2320B	HVBUCK	Yes	Yes	Yes	No	No	Yes	Yes	Yes	Yes	Yes	Yes	ASIL B	Yes	Opt	Yes	Yes	Yes	Yes	Yes	Yes
FS2321B	HVBUCK	Yes	Yes	Yes	Yes	No	Yes	Yes	Yes	Yes	Yes	Yes	ASIL B	Yes	Opt	Yes	Yes	Yes	Yes	Yes	Yes
FS2322B	HVBUCK	Yes	Yes	Yes	No	Yes	Yes	Yes	Yes	Yes	Yes	Yes	ASIL B	Yes	Opt	Yes	Yes	Yes	Yes	Yes	Yes
FS2323B	HVBUCK	Yes	Yes	Yes	Yes	Yes	Yes	Yes	Yes	Yes	Yes	Yes	ASIL B	Yes	Opt	Yes	Yes	Yes	Yes	Yes	Yes
FS2324B	HVBUCK	Yes	Yes	No	Yes	No	Yes	Yes	Yes	Yes	Yes	Yes	ASIL B	Yes	Opt	Yes	Yes	Yes	Yes	Yes	Yes
FS2325B	HVBUCK	Yes	Yes	No	Yes	Yes	Yes	Yes	Yes	Yes	Yes	Yes	ASIL B	Yes	Opt	Yes	Yes	Yes	Yes	Yes	Yes

**Note:** Additional part numbers will exist with different features and parametric settings. The device segmentation is also available on [nxp.com](http://nxp.com).

Table 2 is an example of orderable part number list.

Table 2. Orderable part numbers

Part number	Description	Main properties						Package
		V1 regulator type	V1 voltage	V2 voltage	V3 voltage	SPI or I <sup>2</sup> C	Safety grade	
MFS2323BMBA1EP	Superset for HVBUCK version, ASIL B, CAN, LIN and LDT enabled.	HVBUCK	5 V	3.3 V	5 V	SPI	ASIL B	QFN48EP
MFS2323BMMA2EP	Superset for HVBUCK version, QM, CAN, LIN and LDT enabled.	HVBUCK	5 V	3.3 V	5 V	SPI	QM	
MFS2303BMBA3EP	Superset for HVLDO version, ASIL B, example for S32K1xx MCU, CAN, LIN and LDT enabled.	HVLDO	5 V	3.3 V	5 V	SPI	ASIL B	
MFS2303BMMA4EP	Superset for HVLDO version, QM, CAN, LIN and LDT enabled.	HVLDO	5 V	3.3 V	5 V	SPI	QM	
MFS2323BMBA5EP	Configuration used for S32K311 + FS23 EVB, S32K31X-Q100, CAN, LIN and LDT enabled.	HVBUCK	5 V	3.3 V	5 V	SPI	ASILB	
MFS2303BMMA9EP	Configuration example for door control unit (DCU), CAN, LIN and LDT enabled, external PNP enabled.	HVLDO + ext. PNP	3.3 V	3.3 V	5 V	SPI	QM	
MFS2301BMBA0EP	Configuration example for park lock actuator (PLA), CAN and LIN enabled, LDT disabled.	HVLDO	5 V	5 V	5 V	SPI	ASIL B	
MFS2320BMBB1EP	Configuration example for S32K312 MCU, CAN enabled, LIN and LDT disabled.	HVBUCK	5 V	5 V	5 V	SPI	ASIL B	
MFS2321BMBB2EP	Configuration example for S32K324 MCU, CAN and LIN enabled, LDT disabled.	HVBUCK	5 V	5 V	5 V	SPI	ASIL B	
MFS2323BMBBFEP	Configuration example for battery management system (BMS)	HVBUCK	5 V	5 V	5 V	SPI	ASIL B	
MFS2300BMMA0EP	Superset covering FS2300M devices.	HVLDO	Configurable	Configurable	Configurable	Configurable	QM	
MFS2301BMMA0EP	Superset covering FS2301M devices.	HVLDO	Configurable	Configurable	Configurable	Configurable	QM	
MFS2302BMMA0EP	Superset covering FS2302M devices.	HVLDO	Configurable	Configurable	Configurable	Configurable	QM	
MFS2303BMMA0EP	Superset covering FS2303M devices.	HVLDO	Configurable	Configurable	Configurable	Configurable	QM	
MFS2304BMMA0EP	Superset covering FS2304M devices.	HVLDO	Configurable	Configurable	Configurable	Configurable	QM	
MFS2305BMMA0EP	Superset covering FS2305M devices.	HVLDO	Configurable	Configurable	Configurable	Configurable	QM	
MFS2300BMBA0EP	Superset covering FS2300B devices.	HVLDO	Configurable	Configurable	Configurable	Configurable	ASIL B	
MFS2301BMBA0EP	Superset covering FS2301B devices.	HVLDO	Configurable	Configurable	Configurable	Configurable	ASIL B	
MFS2302BMBA0EP	Superset covering FS2302B devices.	HVLDO	Configurable	Configurable	Configurable	Configurable	ASIL B	
MFS2303BMBA0EP	Superset covering FS2303B devices.	HVLDO	Configurable	Configurable	Configurable	Configurable	ASIL B	
MFS2304BMBA0EP	Superset covering FS2304B devices.	HVLDO	Configurable	Configurable	Configurable	Configurable	ASIL B	
MFS2305BMBA0EP	Superset covering FS2305B devices.	HVLDO	Configurable	Configurable	Configurable	Configurable	ASIL B	
MFS2320BMMA0EP	Superset covering FS2320M devices.	HVBUCK	Configurable	Configurable	Configurable	Configurable	QM	
MFS2321BMMA0EP	Superset covering FS2321M devices.	HVBUCK	Configurable	Configurable	Configurable	Configurable	QM	
MFS2322BMMA0EP	Superset covering FS2322M devices.	HVBUCK	Configurable	Configurable	Configurable	Configurable	QM	
MFS2323BMMA0EP	Superset covering FS2323M devices.	HVBUCK	Configurable	Configurable	Configurable	Configurable	QM	
MFS2324BMMA0EP	Superset covering FS2324M devices.	HVBUCK	Configurable	Configurable	Configurable	Configurable	QM	
MFS2325BMMA0EP	Superset covering FS2325M devices.	HVBUCK	Configurable	Configurable	Configurable	Configurable	QM	
MFS2320BMBA0EP	Superset covering FS2320B devices.	HVBUCK	Configurable	Configurable	Configurable	Configurable	ASIL B	
MFS2321BMBA0EP	Superset covering FS2321B devices.	HVBUCK	Configurable	Configurable	Configurable	Configurable	ASIL B	
MFS2322BMBA0EP	Superset covering FS2322B devices.	HVBUCK	Configurable	Configurable	Configurable	Configurable	ASIL B	
MFS2323BMBA0EP	Superset covering FS2323B devices.	HVBUCK	Configurable	Configurable	Configurable	Configurable	ASIL B	
MFS2324BMBA0EP	Superset covering FS2324B devices.	HVBUCK	Configurable	Configurable	Configurable	Configurable	ASIL B	
MFS2325BMBA0EP	Superset covering FS2325B devices.	HVBUCK	Configurable	Configurable	Configurable	Configurable	ASIL B	

5 Block diagram

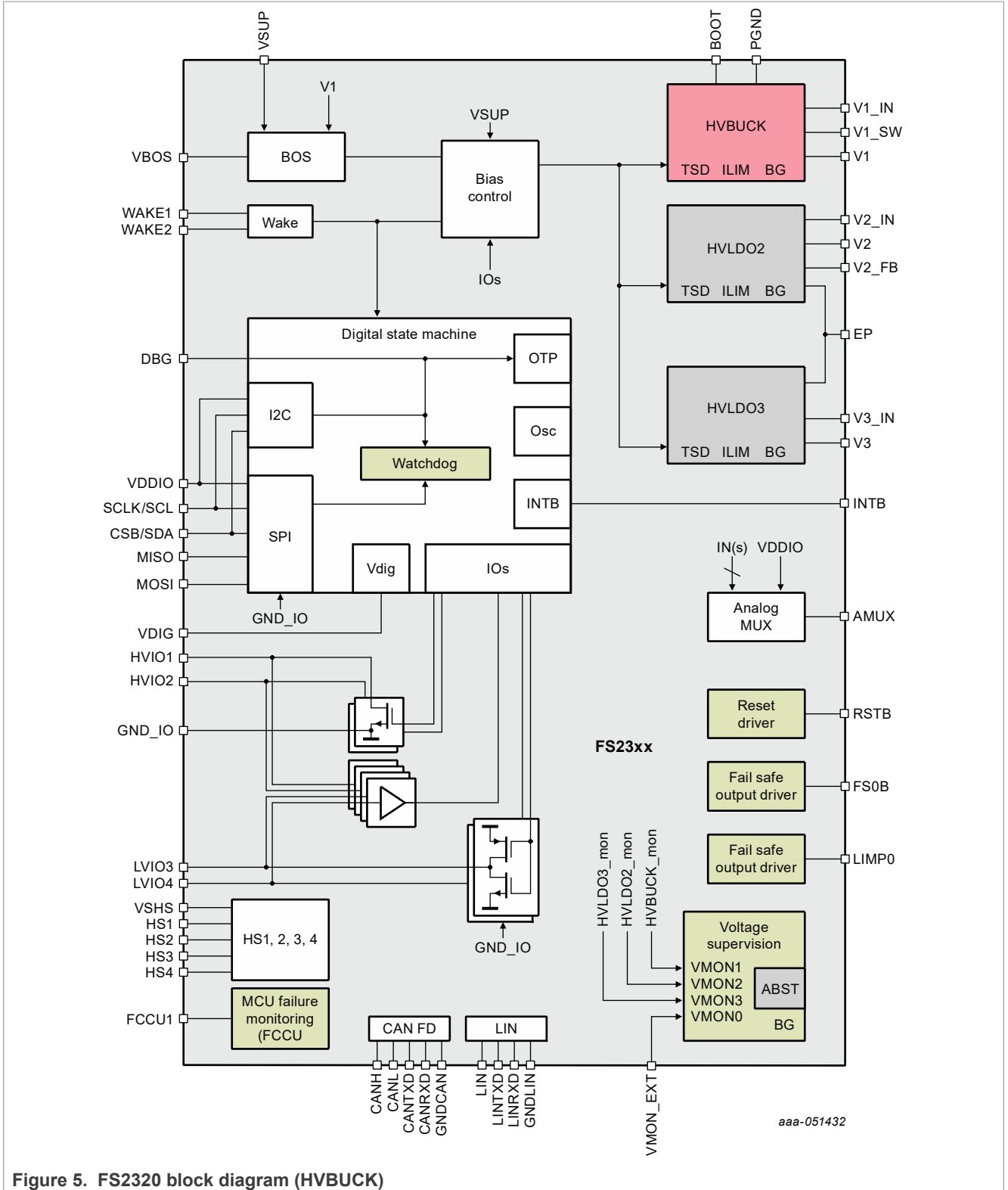

Figure 5. FS2320 block diagram (HVBUCK)



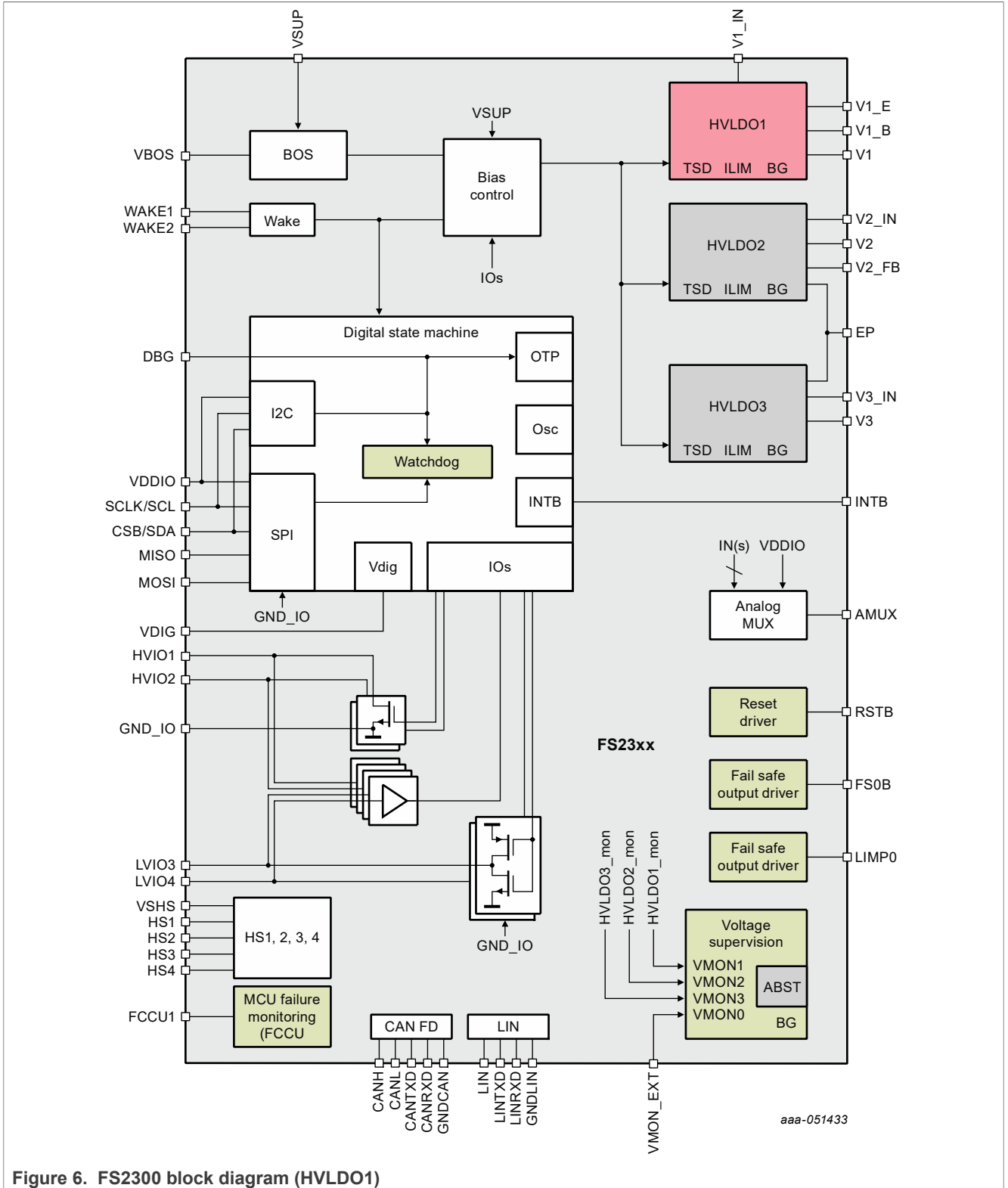
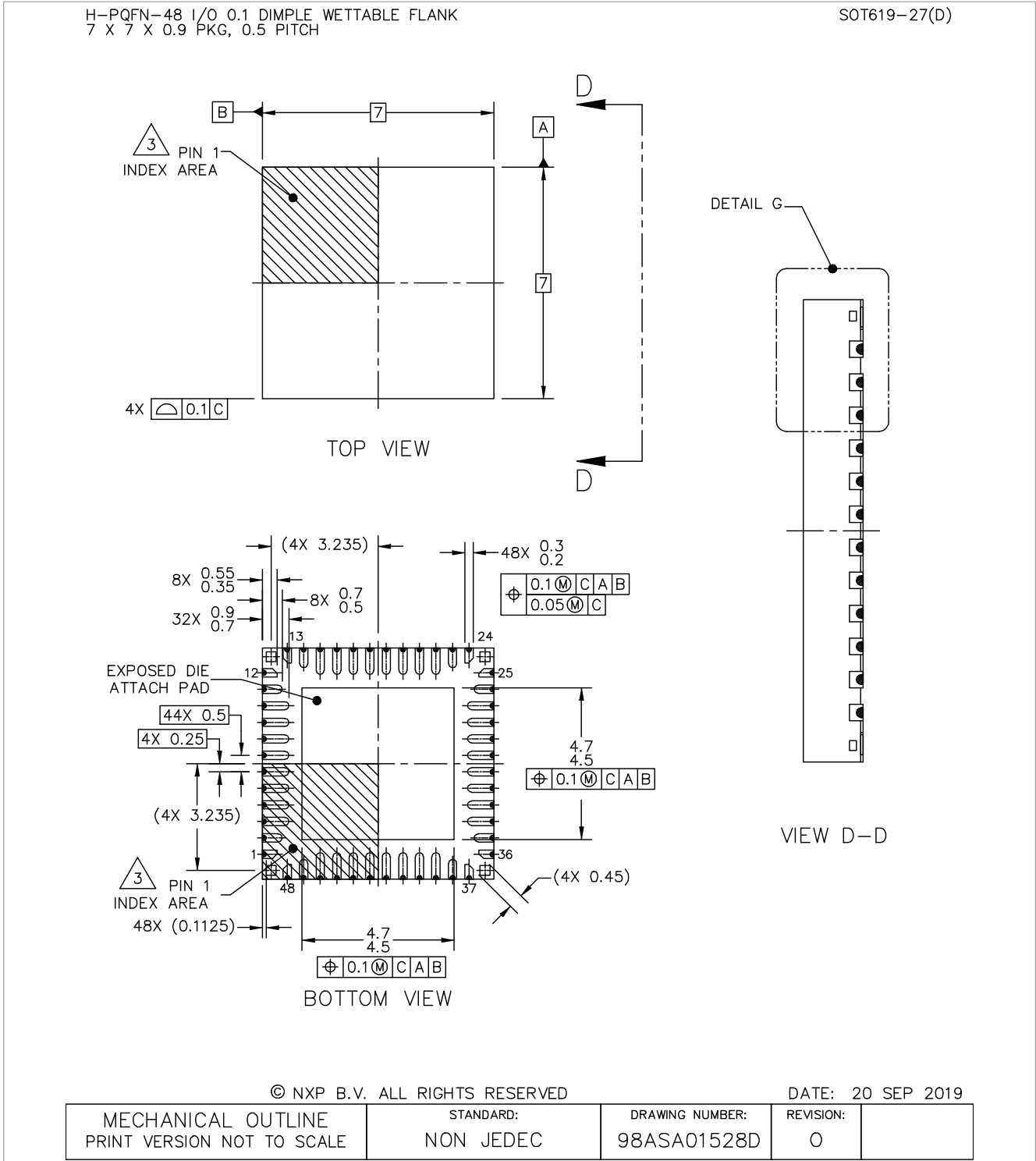

Figure 6. FS2300 block diagram (HVLDO1)

6 Package drawing



Safety system basis chip (SBC) with power management, CAN FD and LIN transceivers

H-PQFN-48 I/O 0.1 DIMPLE WETTABLE FLANK  
7 X 7 X 0.9 PKG, 0.5 PITCH

SOT619-27(D)

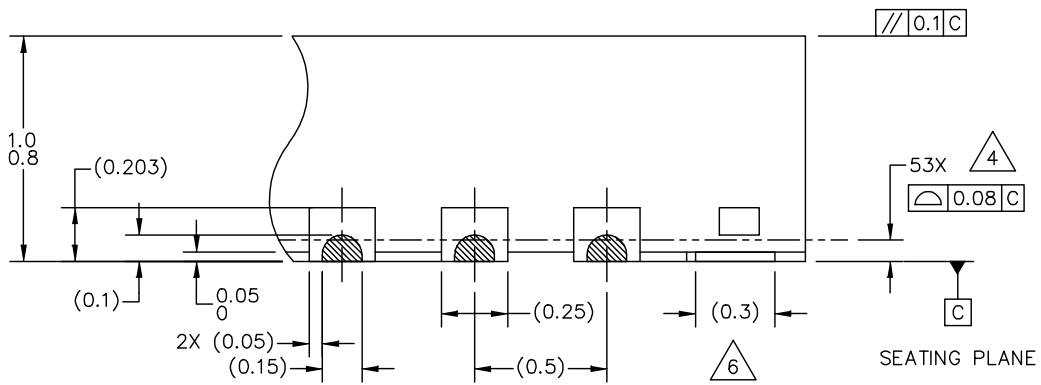

DETAIL G  
VIEW ROTATED 90° CW

© NXP B.V. ALL RIGHTS RESERVED

DATE: 20 SEP 2019

MECHANICAL OUTLINE PRINT VERSION NOT TO SCALE	STANDARD: NON JEDEC	DRAWING NUMBER: 98ASA01528D	REVISION: 0	
--	------------------------	--------------------------------	----------------	--

Safety system basis chip (SBC) with power management, CAN FD and LIN transceivers

H-PQFN-48 I/O 0.1 DIMPLE WETTABLE FLANK  
7 X 7 X 0.9 PKG, 0.5 PITCH

SOT619-27(D)

NOTES:

1. ALL DIMENSIONS ARE IN MILLIMETERS.
2. DIMENSIONING AND TOLERANCING PER ASME Y14.5M-1994.
3. PIN 1 FEATURE SHAPE, SIZE AND LOCATION MAY VARY.
4. COPLANARITY APPLIES TO LEADS AND DIE ATTACH PAD.
5. MIN. METAL GAP FOR LEAD TO EXPOSED PAD SHALL BE 0.2 MM.
6. ANCHORING PADS.

© NXP B.V. ALL RIGHTS RESERVED

DATE: 20 SEP 2019

MECHANICAL OUTLINE PRINT VERSION NOT TO SCALE	STANDARD: NON JEDEC	DRAWING NUMBER: 98ASA01528D	REVISION: 0	
--	------------------------	--------------------------------	----------------	--

## 7 Revision history

Revision	Date	Description of changes
FS23_PB v 3	26 February 2024	<ul style="list-style-type: none"><li>• Global editing for NXP style and grammar</li><li>• Updated Document title and DocID</li><li>• Updated <a href="#">Section 2</a></li><li>• Updated <a href="#">Table 1</a>, <a href="#">Table 2</a></li><li>• Updated <a href="#">Figure 1</a>, <a href="#">Figure 3</a>, <a href="#">Figure 4</a>,</li></ul>
FS23_PB v 2.1	30 October 20223	<ul style="list-style-type: none"><li>• Updated Document title</li></ul>
FS23_PB v 2	20 October 2023	<ul style="list-style-type: none"><li>• Updated appearance of Revision history</li><li>• Updated Document title and identifier</li><li>• Updated <a href="#">Section 1</a>; <a href="#">Section 2</a>; <a href="#">Section 3</a>; <a href="#">Section 4</a>; <a href="#">Legal information</a></li><li>• Removed section titled "Data sheet status"</li></ul>
FS23_PB v 1	08 June 2022	Initial version

## Legal information

### Definitions

**Draft** — A draft status on a document indicates that the content is still under internal review and subject to formal approval, which may result in modifications or additions. NXP Semiconductors does not give any representations or warranties as to the accuracy or completeness of information included in a draft version of a document and shall have no liability for the consequences of use of such information.

### Disclaimers

**Limited warranty and liability** — Information in this document is believed to be accurate and reliable. However, NXP Semiconductors does not give any representations or warranties, expressed or implied, as to the accuracy or completeness of such information and shall have no liability for the consequences of use of such information. NXP Semiconductors takes no responsibility for the content in this document if provided by an information source outside of NXP Semiconductors.

In no event shall NXP Semiconductors be liable for any indirect, incidental, punitive, special or consequential damages (including - without limitation - lost profits, lost savings, business interruption, costs related to the removal or replacement of any products or rework charges) whether or not such damages are based on tort (including negligence), warranty, breach of contract or any other legal theory.

Notwithstanding any damages that customer might incur for any reason whatsoever, NXP Semiconductors' aggregate and cumulative liability towards customer for the products described herein shall be limited in accordance with the Terms and conditions of commercial sale of NXP Semiconductors.

**Right to make changes** — NXP Semiconductors reserves the right to make changes to information published in this document, including without limitation specifications and product descriptions, at any time and without notice. This document supersedes and replaces all information supplied prior to the publication hereof.

**Applications** — Applications that are described herein for any of these products are for illustrative purposes only. NXP Semiconductors makes no representation or warranty that such applications will be suitable for the specified use without further testing or modification.

Customers are responsible for the design and operation of their applications and products using NXP Semiconductors products, and NXP Semiconductors accepts no liability for any assistance with applications or customer product design. It is customer's sole responsibility to determine whether the NXP Semiconductors product is suitable and fit for the customer's applications and products planned, as well as for the planned application and use of customer's third party customer(s). Customers should provide appropriate design and operating safeguards to minimize the risks associated with their applications and products.

NXP Semiconductors does not accept any liability related to any default, damage, costs or problem which is based on any weakness or default in the customer's applications or products, or the application or use by customer's third party customer(s). Customer is responsible for doing all necessary testing for the customer's applications and products using NXP Semiconductors products in order to avoid a default of the applications and the products or of the application or use by customer's third party customer(s). NXP does not accept any liability in this respect.

**Limiting values** — Stress above one or more limiting values (as defined in the Absolute Maximum Ratings System of IEC 60134) will cause permanent damage to the device. Limiting values are stress ratings only and (proper) operation of the device at these or any other conditions above those given in the Recommended operating conditions section (if present) or the Characteristics sections of this document is not warranted. Constant or repeated exposure to limiting values will permanently and irreversibly affect the quality and reliability of the device.

**Terms and conditions of commercial sale** — NXP Semiconductors products are sold subject to the general terms and conditions of commercial sale, as published at <https://www.nxp.com/profile/terms>, unless otherwise agreed in a valid written individual agreement. In case an individual agreement is concluded only the terms and conditions of the respective agreement shall apply. NXP Semiconductors hereby expressly objects to applying the customer's general terms and conditions with regard to the purchase of NXP Semiconductors products by customer.

**No offer to sell or license** — Nothing in this document may be interpreted or construed as an offer to sell products that is open for acceptance or the grant, conveyance or implication of any license under any copyrights, patents or other industrial or intellectual property rights.

**Quick reference data** — The Quick reference data is an extract of the product data given in the Limiting values and Characteristics sections of this document, and as such is not complete, exhaustive or legally binding.

**Export control** — This document as well as the item(s) described herein may be subject to export control regulations. Export might require a prior authorization from competent authorities.

**Translations** — A non-English (translated) version of a document, including the legal information in that document, is for reference only. The English version shall prevail in case of any discrepancy between the translated and English versions.

**Security** — Customer understands that all NXP products may be subject to unidentified vulnerabilities or may support established security standards or specifications with known limitations. Customer is responsible for the design and operation of its applications and products throughout their lifecycles to reduce the effect of these vulnerabilities on customer's applications and products. Customer's responsibility also extends to other open and/or proprietary technologies supported by NXP products for use in customer's applications. NXP accepts no liability for any vulnerability. Customer should regularly check security updates from NXP and follow up appropriately.

Customer shall select products with security features that best meet rules, regulations, and standards of the intended application and make the ultimate design decisions regarding its products and is solely responsible for compliance with all legal, regulatory, and security related requirements concerning its products, regardless of any information or support that may be provided by NXP.

NXP has a Product Security Incident Response Team (PSIRT) (reachable at [PSIRT@nxp.com](mailto:PSIRT@nxp.com)) that manages the investigation, reporting, and solution release to security vulnerabilities of NXP products.

**Suitability for use in automotive applications (functional safety)** —

This NXP product has been qualified for use in automotive applications. It has been developed in accordance with ISO 26262, and has been ASIL classified accordingly. If this product is used by customer in the development of, or for incorporation into, products or services (a) used in safety critical applications or (b) in which failure could lead to death, personal injury, or severe physical or environmental damage (such products and services hereinafter referred to as "Critical Applications"), then customer makes the ultimate design decisions regarding its products and is solely responsible for compliance with all legal, regulatory, safety, and security related requirements concerning its products, regardless of any information or support that may be provided by NXP. As such, customer assumes all risk related to use of any products in Critical Applications and NXP and its suppliers shall not be liable for any such use by customer. Accordingly, customer will indemnify and hold NXP harmless from any claims, liabilities, damages and associated costs and expenses (including attorneys' fees) that NXP may incur related to customer's incorporation of any product in a Critical Application.

**NXP B.V.** — NXP B.V. is not an operating company and it does not distribute or sell products.

## Trademarks

**NXP** — wordmark and logo are trademarks of NXP B.V.

Notice: All referenced brands, product names, service names, and trademarks are the property of their respective owners.

**Tables**

Tab. 1. Device segmentation .....6      Tab. 2. Orderable part numbers ..... 7



## Figures

Fig. 1.	Functional block diagram .....	2	Fig. 4.	Part numbers mapping versus base feature sets .....	5
Fig. 2.	Full FS23 part numbers breakdown .....	5	Fig. 5.	FS2320 block diagram (HVBUCK) .....	8
Fig. 3.	Simplified FS23 part numbers breakdown .....	5	Fig. 6.	FS2300 block diagram (HVLDO1) .....	9

## Contents

---

<b>1</b>	<b>General description .....</b>	<b>1</b>
<b>2</b>	<b>Features and benefits .....</b>	<b>3</b>
<b>3</b>	<b>Applications .....</b>	<b>4</b>
<b>4</b>	<b>Ordering information .....</b>	<b>5</b>
4.1	Part numbers definition .....	5
4.2	Part numbers list .....	6
<b>5</b>	<b>Block diagram .....</b>	<b>8</b>
<b>6</b>	<b>Package drawing .....</b>	<b>10</b>
<b>7</b>	<b>Revision history .....</b>	<b>13</b>
	<b>Legal information .....</b>	<b>14</b>

---

Please be aware that important notices concerning this document and the product(s) described herein, have been included in section 'Legal information'.

---

© 2024 NXP B.V.

All rights reserved.

For more information, please visit: <https://www.nxp.com>

Date of release: 26 February 2024  
Document identifier: FS23\_PB