

SOT1161-1

Standard product orientation 12NC ending 115

Rev. 02 — 27 July 2011

Packing information

1. Packing method

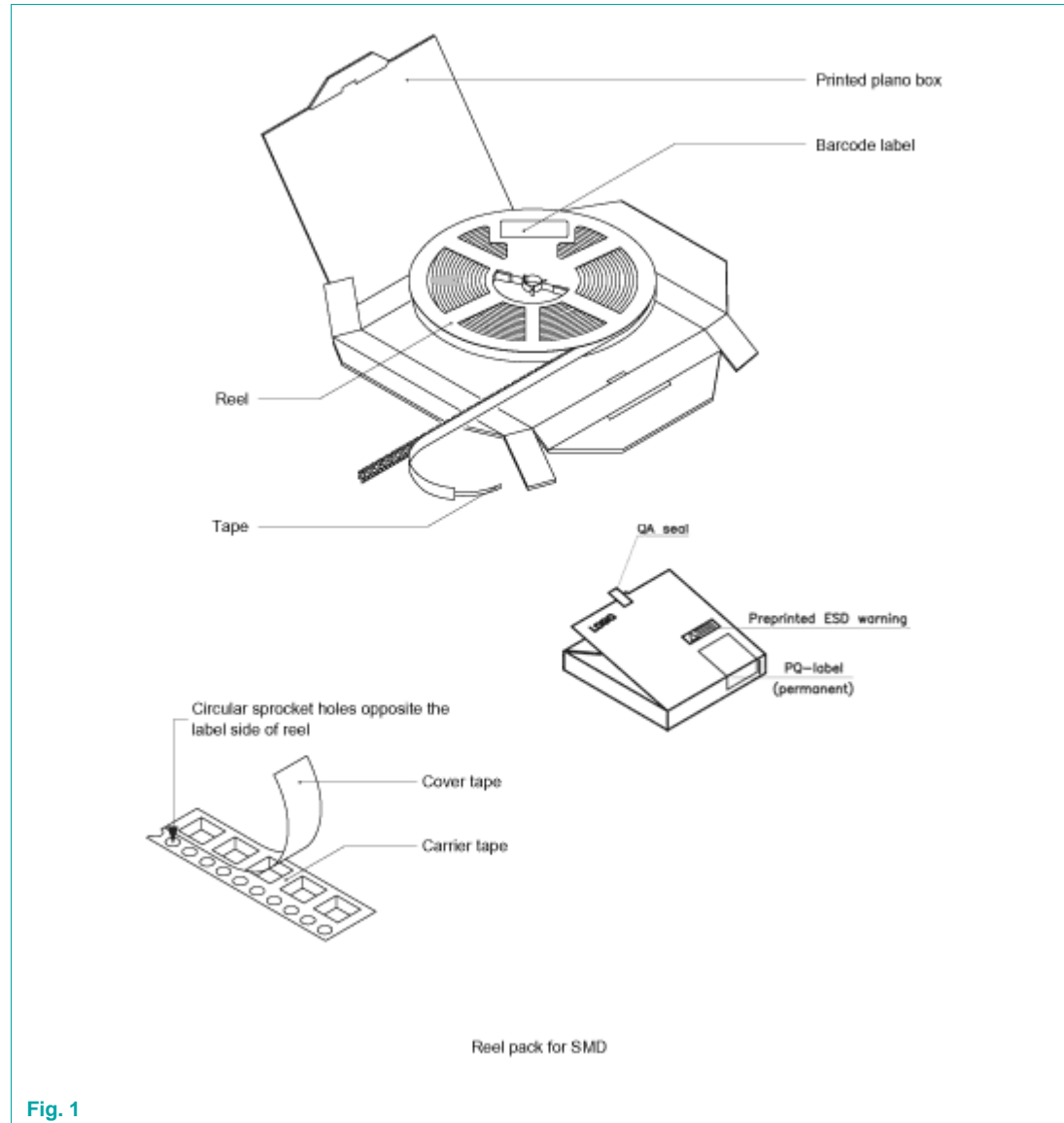

Package version	12NC ending	Reel dimensions d x w (mm)	SPQ/PQ (pcs)	Reels per box	Outer box dimensions l x w x h (mm)
SOT1161-1	115	180 x 8	4000	1	185 x 185 x 14

2. Product orientation

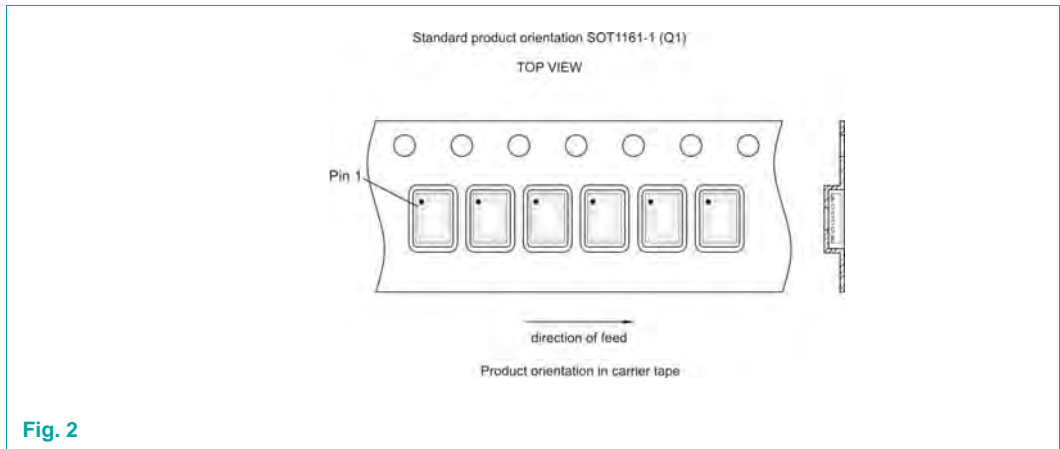

3. Carrier tape dimensions

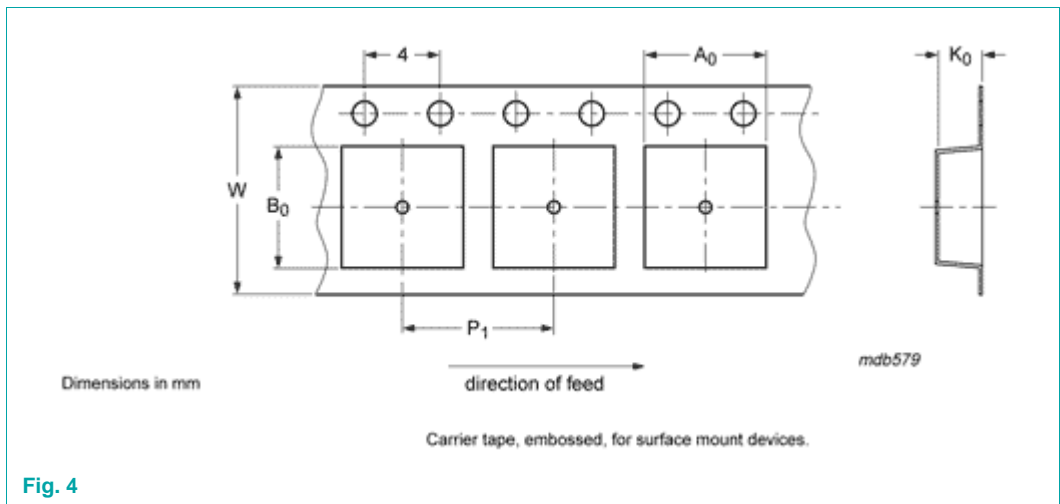

12NC ending	A ₀ (mm)	B ₀ (mm)	K ₀ (mm)	T (mm)	P ₁ (mm)	W (mm)
115	2.10	2.90	0.75	-	4.0	8

4. Carrier tape dimensions

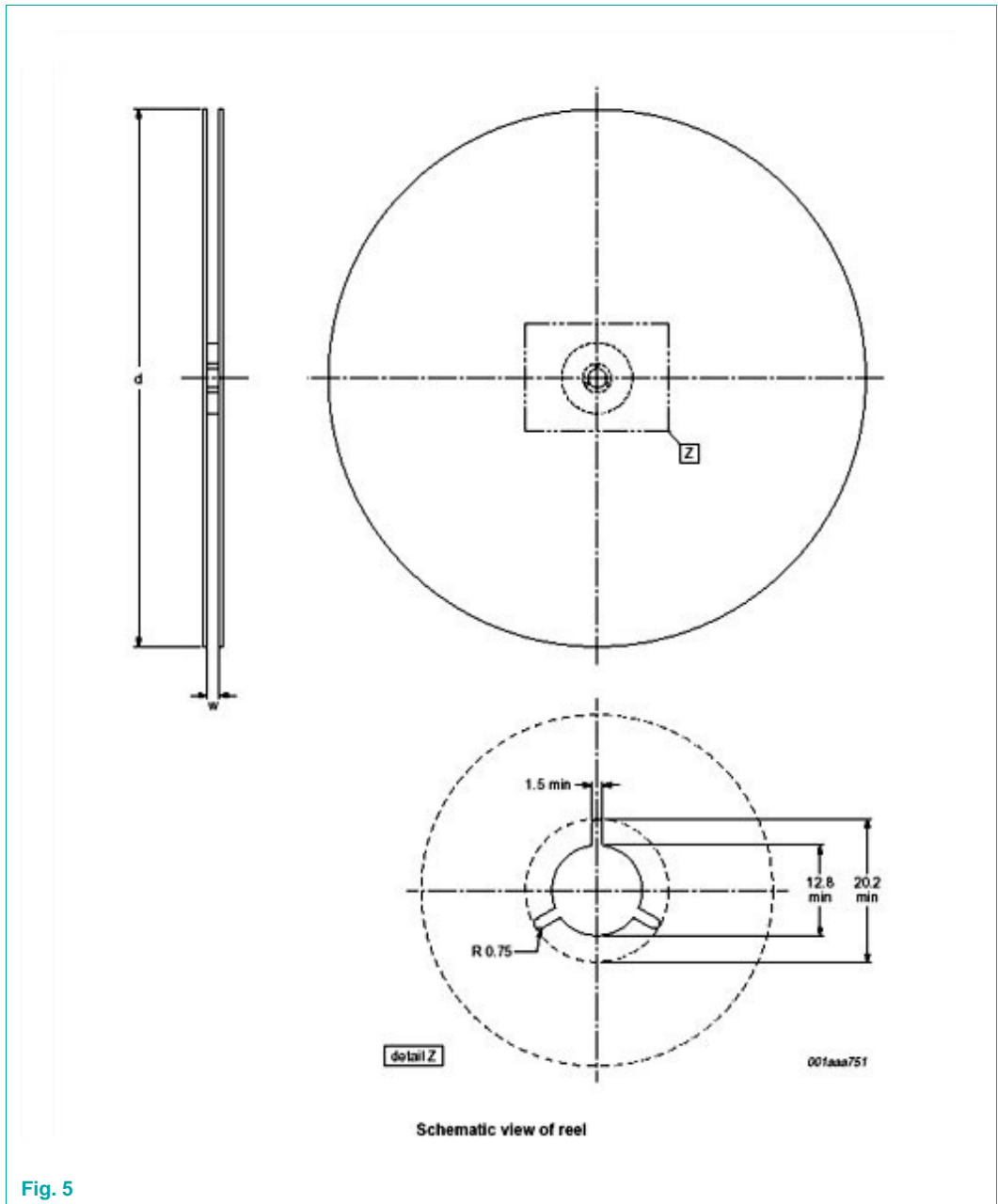

Fig. 5

Package version	12NC ending	Reel dimensions d x w (mm)	SPQ/PQ (pcs)
SOT1161-1	115	180 x 8	4000

5. Barcode label tape and box information

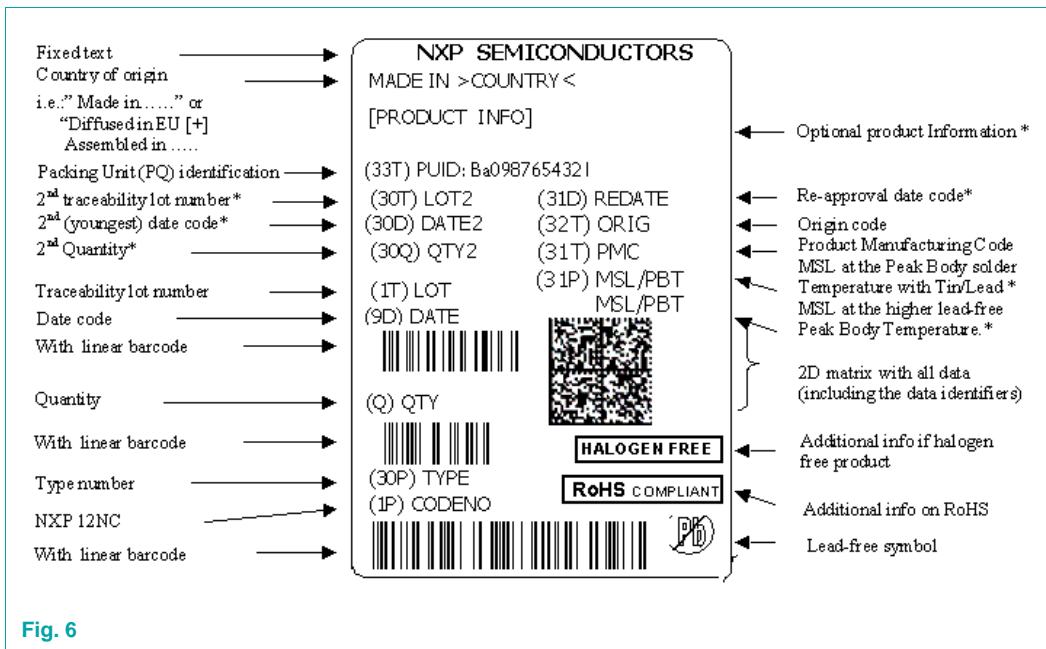

Fig. 6

Label dimensions

l x w (mm)

100 x 75