



SOD523

Tape reel; standard product orientation 12NC ending 315

Rev. 1 — 4 October 2012

Packing information

1. Packing method

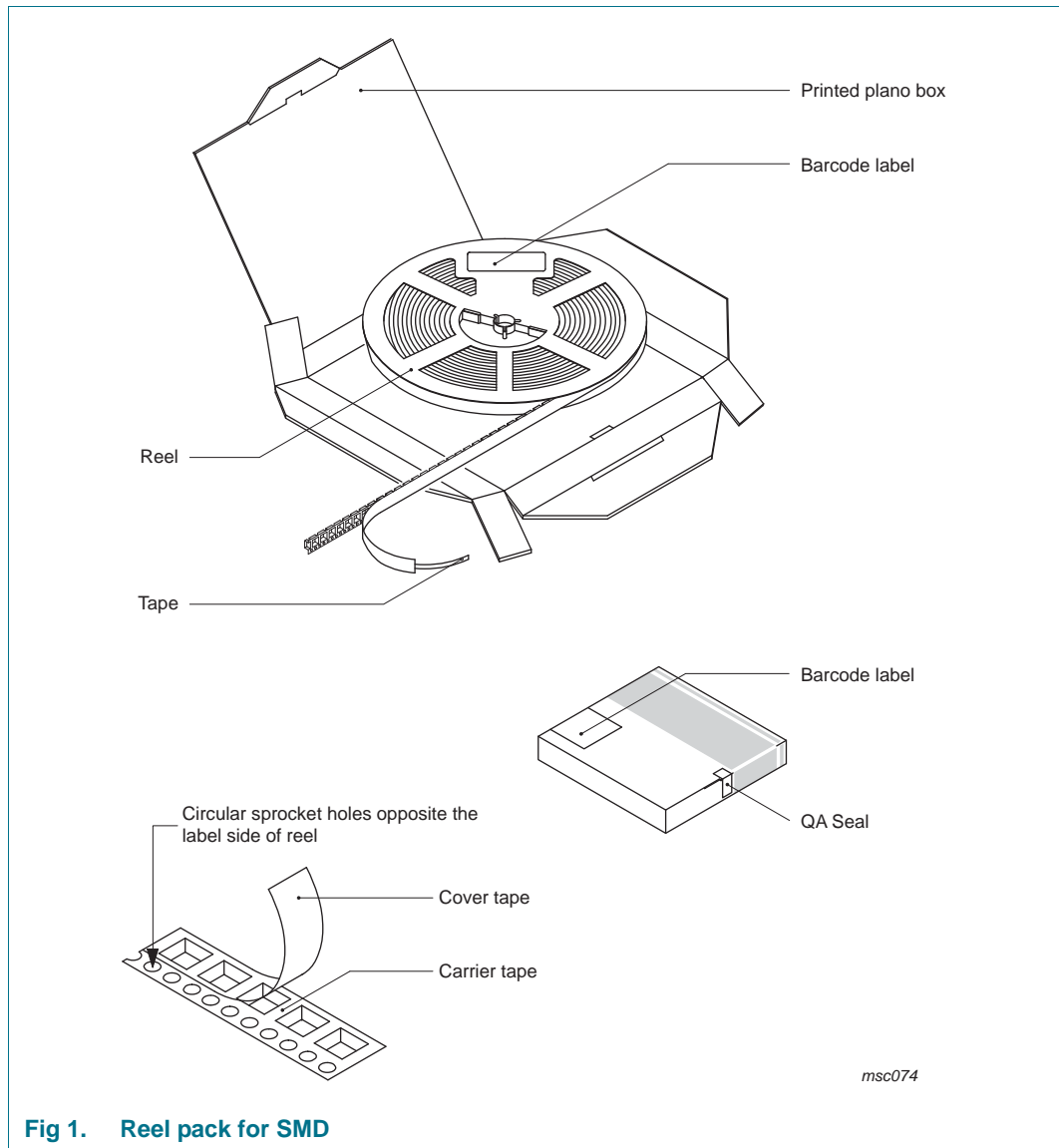

Table 1. Packing information

Package version	12NC ending	Reel dimensions d x w (mm) ^[1]	SPQ/PQ (pcs)	Reels per box	Outer box dimensions l x w x h (mm)
SOD523	315	180 x 8	8000	1	186 x 186 x 16

[1] d = reel diameter; w = tape width.



2. Product orientation

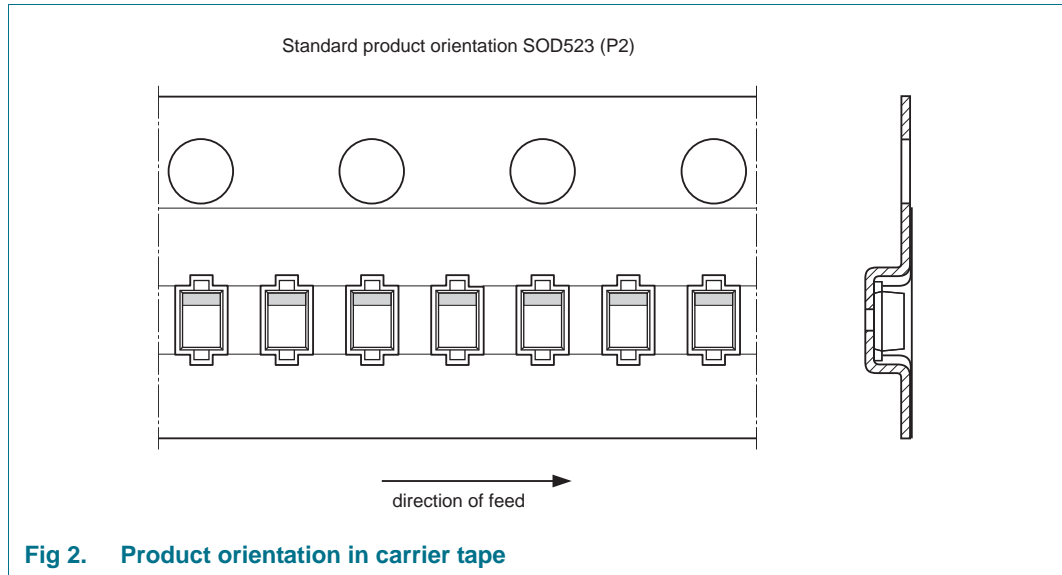

3. Carrier tape dimensions

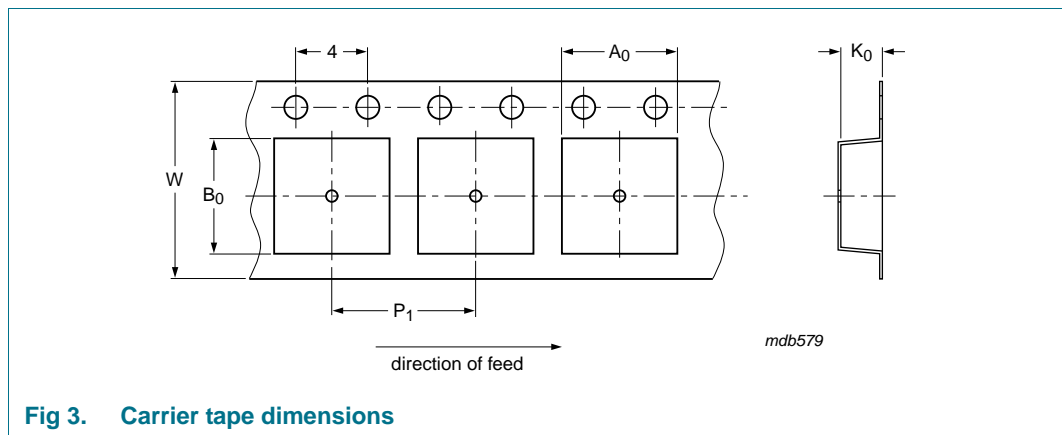

Table 2. Carrier tape dimensions

In accordance with IEC 60286-3.

A ₀ (mm)	B ₀ (mm)	K ₀ (mm)	T (mm)	P ₁ (mm)	W (mm)
0.9	1.95	0.7	-	2.0	8

Limited warranty and liability

Information in this document is believed to be accurate and reliable. However, NXP Semiconductors does not give any representations or warranties, expressed or implied, as to the accuracy or completeness of such information and shall have no liability for the consequences of use of such information.

© NXP B.V. 2012.

For more information, please visit: <http://www.nxp.com>
For sales office addresses, please send an email to: salesaddresses@nxp.com

All rights reserved.

Date of release: 4 October 2012
Document identifier: SOD523_315