Introduction

This mask set errata applies to this MC68HC711E9 MCU mask set:

- 1K81H

MCU Device Mask Set Identification

The mask set is identified by a 5-character code consisting of a version number, a letter, two numerical digits, and a letter, for example 1K81H. All standard devices are marked with a mask set number and a date code.

MCU Device Date Codes

Device markings indicate the week of manufacture and the mask set used. The date is coded as four numerical digits where the first two digits indicate the year and the last two digits indicate the work week. For instance, the date code "0301" indicates the first week of the year 2003.

MCU Device Part Number Prefixes

Some MCU samples and devices are marked with an SC, PC, or XC prefix. An SC prefix denotes special/custom device. A PC prefix indicates a prototype device which has undergone basic testing only. An XC prefix denotes that the device is tested but is not fully characterized or qualified over the full range of normal manufacturing process variations. After full characterization and qualification, devices will be marked with the MC or SC prefix.

V_{PPE} Pin Programming Current Sensitivity

Description: During EPROM programming of the MC68HC711E9 device, the V_{PPE} pin circuitry may latch up and be damaged if the input current is not limited to 10 mA.

Programming the EPROM without an input current limit may destroy the programming functionality. This condition has been experienced on various programming systems (including in-circuit programming) where no current limit on the V_{PPE} pin exists.

Workaround: Limiting the current to the XIRQ/V_{PPE} pin with a resistor can protect the EPROM voltage circuit even when the voltage is bouncing on V_{PPE} and will allow enough current to program the EPROM array. Motorola recommends that V_{PP} remain within specification of 11.75 V to 12.75 V during programming because the resistor will cause V_{PP} to drop.

Also, adding a 100-Ω resistor and capacitor to the XIRQ/V_{PPE} pin can reduce the occurrence of latchup and allow programming the EPROM array within V_{PP} specification. This does not ensure current will remain below 10 mA. See [Figure 1](#) for an example circuit.

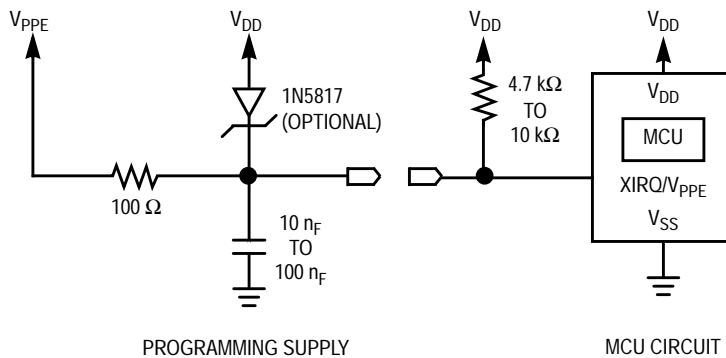

Figure 1. Example Circuit



HOW TO REACH US:**USA/EUROPE/LOCATIONS NOT LISTED:**

Motorola Literature Distribution;
P.O. Box 5405, Denver, Colorado 80217
1-303-675-2140 or 1-800-441-2447

JAPAN:

Motorola Japan Ltd.; SPS, Technical Information Center,
3-20-1, Minami-Azabu Minato-ku, Tokyo 106-8573 Japan
81-3-3440-3569

ASIA/PACIFIC:

Motorola Semiconductors H.K. Ltd.;
Silicon Harbour Centre, 2 Dai King Street,
Tai Po Industrial Estate, Tai Po, N.T., Hong Kong
852-26668334

TECHNICAL INFORMATION CENTER:

1-800-521-6274

HOME PAGE:

<http://www.motorola.com/semiconductors>

Information in this document is provided solely to enable system and software implementers to use Motorola products. There are no express or implied copyright licenses granted hereunder to design or fabricate any integrated circuits or integrated circuits based on the information in this document.

Motorola reserves the right to make changes without further notice to any products herein. Motorola makes no warranty, representation or guarantee regarding the suitability of its products for any particular purpose, nor does Motorola assume any liability arising out of the application or use of any product or circuit, and specifically disclaims any and all liability, including without limitation consequential or incidental damages. "Typical" parameters which may be provided in Motorola data sheets and/or specifications can and do vary in different applications and actual performance may vary over time. All operating parameters, including "Typicals" must be validated for each customer application by customer's technical experts. Motorola does not convey any license under its patent rights nor the rights of others. Motorola products are not designed, intended, or authorized for use as components in systems intended for surgical implant into the body, or other applications intended to support or sustain life, or for any other application in which the failure of the Motorola product could create a situation where personal injury or death may occur. Should Buyer purchase or use Motorola products for any such unintended or unauthorized application, Buyer shall indemnify and hold Motorola and its officers, employees, subsidiaries, affiliates, and distributors harmless against all claims, costs, damages, and expenses, and reasonable attorney fees arising out of, directly or indirectly, any claim of personal injury or death associated with such unintended or unauthorized use, even if such claim alleges that Motorola was negligent regarding the design or manufacture of the part.



Motorola and the Stylized M Logo are registered in the U.S. Patent and Trademark Office. digital dna is a trademark of Motorola, Inc. All other product or service names are the property of their respective owners. Motorola, Inc. is an Equal Opportunity/Affirmative Action Employer.

© Motorola, Inc. 2003