

TDA3673

Very low dropout voltage/quiescent current 3.3 V voltage regulator with enable

Rev. 05 — 10 June 2005

Product data sheet

1. General description

The TDA3673 is a fixed 3.3 V voltage regulator with very low dropout voltage and quiescent current, which operates over a wide supply voltage range.

2. Features

- Fixed 3.3 V, 100 mA regulator with enable function
- Supply voltage range up to 45 V
- Very low quiescent current of 15 μ A (typical value)
- Very low dropout voltage
- High ripple rejection
- Protections:
 - ◆ Reverse polarity safe (down to -25 V without high reverse current)
 - ◆ Negative transient of 50 V ($R_S = 10 \Omega$, $t < 100$ ms)
 - ◆ Able to withstand voltages up to 18 V at the output (supply line may be short-circuited)
 - ◆ ESD protection on all pins
 - ◆ DC short-circuit safe to ground and V_P of the regulator output
 - ◆ Temperature protection (at $T_j > 150$ °C)

3. Quick reference data

Table 1: Quick reference data

$V_P = 14.4$ V; $T_{amb} = 25$ °C; unless otherwise specified.

Symbol	Parameter	Conditions	Min	Typ	Max	Unit
Supply						
V_P	supply voltage	regulator on	[1] 3	14.4	45	V
I_q	quiescent supply current	$I_{REG} = 0$ mA; $V_{I(EN)} = 5$ V	-	15	30	μ A
Voltage regulator						
V_{REG}	output voltage	8 V $\leq V_P \leq 22$ V; $I_{REG} = 0.5$ mA	3.16	3.3	3.44	V
		6 V $\leq V_P \leq 45$ V; $I_{REG} = 0.5$ mA	3.13	3.3	3.47	V
		0.5 mA $\leq I_{REG} \leq 100$ mA	3.13	3.3	3.47	V
$V_{REG(drop)}$	dropout voltage	$V_P = 3.1$ V; $I_{REG} = 50$ mA; $T_{amb} \leq 85$ °C	-	0.18	0.3	V

[1] The regulator output will follow V_P if $V_P < V_{REG} + V_{REG(drop)}$.

4. Ordering information

Table 2: Ordering information

Type number	Package		
	Name	Description	Version
TDA3673AT	SO8	plastic small outline package; 8 leads; body width 3.9 mm	SOT96-1

5. Block diagram

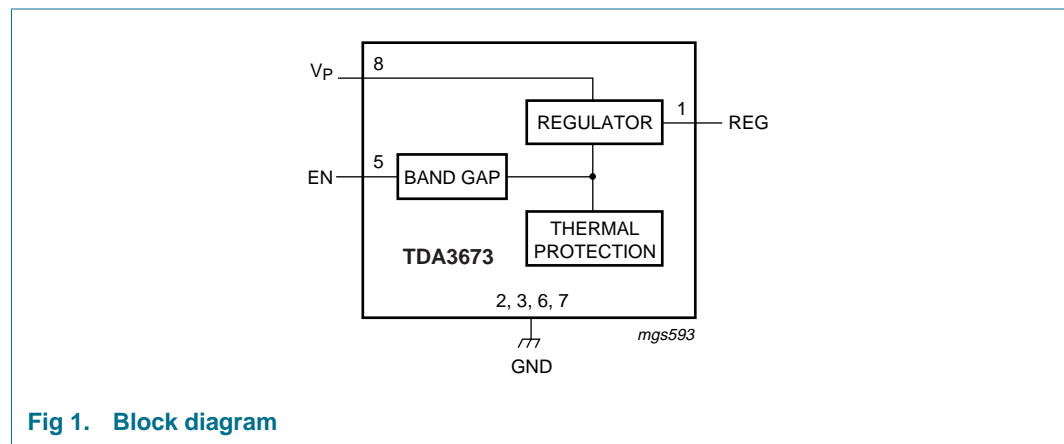

6. Pinning information

6.1 Pinning

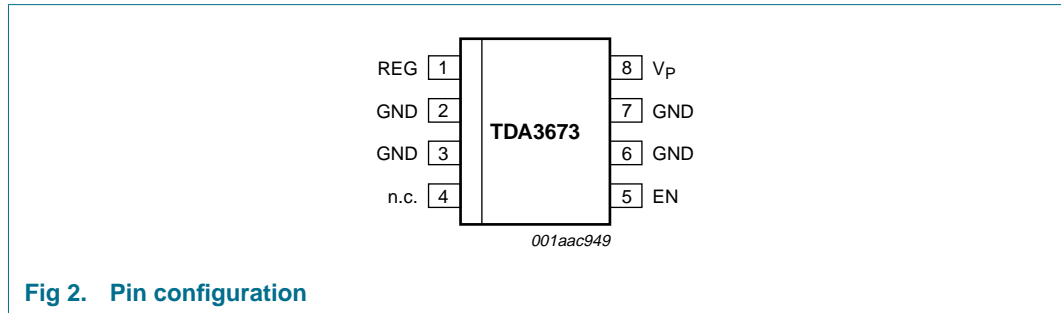

6.2 Pin description

Table 3: Pin description

Symbol	Pin	Description
REG	1	regulator output
GND	2, 3, 6 and 7	ground [1]
n.c.	4	not connected
EN	5	enable input
V _P	8	supply voltage

[1] All GND pins are connected to the lead frame and can also be used to reduce the total thermal resistance $R_{th(j-a)}$ by soldering these pins to a ground plane. The ground plane on the top side of the PCB acts like a heat spreader.

7. Functional description

The TDA3673 is a fixed 3.3 V regulator which can deliver output currents up to 100 mA. The regulator is available in an SO8 package with fused centre pins connected to the lead frame. The regulator is intended for portable, mains and telephone applications. To increase the lifetime of batteries, a specially built-in clamp circuit keeps the quiescent current of this regulator very low, also in dropout and full load conditions.

The regulator remains operating down to very low supply voltages and below it switches off.

A temperature protection circuit is included, which switches off the regulator output at a junction temperature above 150 °C.

8. Limiting values

Table 4: Limiting values

In accordance with the Absolute Maximum Rating System (IEC 60134).

Symbol	Parameter	Conditions	Min	Max	Unit
V_P	supply voltage		-	45	V
$V_{P(rp)}$	reverse polarity supply voltage	non-operating	-	-25	V
P_{tot}	total power dissipation	temperature of copper area is 25 °C	-	4.1	W
T_{stg}	storage temperature	non-operating	-55	+150	°C
T_{amb}	ambient temperature	operating	-40	+125	°C
T_j	junction temperature	operating	-40	+150	°C

9. Thermal characteristics

Table 5: Thermal characteristics

Symbol	Parameter	Conditions	Typ	Unit
$R_{th(j-a)}$	thermal resistance from junction to ambient	in free air; soldered	155	K/W
$R_{th(j-c)}$	thermal resistance from junction to case	to center pins; soldered	30	K/W

10. Characteristics

Table 6: Characteristics

$V_P = 14.4$ V; $T_{amb} = 25$ °C; measured in test circuit of [Figure 14](#); unless otherwise specified.

Symbol	Parameter	Conditions	Min	Typ	Max	Unit
Supply voltage: pin V_P						
V_P	supply voltage	regulator operating	[1] 3	14.4	45	V
I_q	quiescent supply current	$V_P = 14.4$ V; $I_{REG} = 0$ mA; $V_{I(EN)} = 0$ V	-	4	15	μA
		$V_P = 14.4$ V; $I_{REG} = 0$ mA; $V_{I(EN)} = 5$ V	-	15	30	μA
		6 V $\leq V_P \leq 22$ V; $I_{REG} = 10$ mA	-	0.2	0.5	mA
		6 V $\leq V_P \leq 22$ V; $I_{REG} = 50$ mA	-	1.4	2.5	mA
Enable input: pin EN						
$V_{I(EN)}$	enable input voltage	enable off; $V_{REG} \leq 0.8$ V	-1	-	+1.0	V
		enable on; $V_{REG} \geq 3$ V	3.0	-	18	V
$I_{I(EN)}$	enable input current	$V_{I(EN)} = 5$ V	-	0.3	-	μA
Regulator output: pin REG						
V_{REG}	output voltage	8 V $\leq V_P \leq 22$ V; $I_{REG} = 0.5$ mA	3.16	3.3	3.44	V
		0.5 mA $\leq I_{REG} \leq 100$ mA	3.13	3.3	3.47	V
		6 V $\leq V_P \leq 45$ V; $I_{REG} = 0.5$ mA	3.13	3.3	3.47	V
$V_{REG(drop)}$	dropout voltage	$V_P = 3.1$ V; $T_{amb} \leq 85$ °C; $I_{REG} = 50$ mA	-	0.18	0.3	V
$V_{REG(stab)}$	output voltage long-term stability	per 1000 h	-	20	-	mV

Table 6: Characteristics ...continued $V_P = 14.4\text{ V}$; $T_{amb} = 25\text{ }^\circ\text{C}$; measured in test circuit of [Figure 14](#); unless otherwise specified.

Symbol	Parameter	Conditions	Min	Typ	Max	Unit
$\Delta V_{REG(line)}$	line input regulation voltage	$7\text{ V} \leq V_P \leq 22\text{ V}$; $I_{REG} = 0.5\text{ mA}$	-	1	30	mV
		$7\text{ V} \leq V_P \leq 45\text{ V}$; $I_{REG} = 0.5\text{ mA}$	-	1	50	mV
$\Delta V_{REG(load)}$	load output regulation voltage	$0.5\text{ mA} \leq I_{REG} \leq 50\text{ mA}$	-	10	50	mV
SVRR	supply voltage ripple rejection	$f_i = 120\text{ Hz}$; $V_{i(ripple)} = 1\text{ V (RMS)}$; $I_{REG} = 0.5\text{ mA}$	50	60	-	dB
$I_{REG(cr)}$	output current limit	$V_{REG} > 2.8\text{ V}$	0.17	0.25	-	A
$I_{LO(rp)}$	output leakage current at reverse polarity input	$V_P = -15\text{ V}$; $V_{REG} \leq 0.3\text{ V}$	-	1	500	μA

[1] The regulator output will follow V_P if $V_P < V_{REG} + V_{REG(drop)}$.

11. Application information

11.1 Noise

The output noise is determined by the value of the output capacitor (see [Table 7](#)).

Table 7: Noise figures

Output current I_{REG} (mA)	Noise figure (μV) [1]		
	C2 = 10 μF	C2 = 47 μF	C2 = 100 μF
0.5	550	320	300
50	650	400	400

[1] Measured at a bandwidth of 10 Hz to 100 kHz

11.2 Stability

The regulator is stabilized with an external capacitor on the output.

For stable operation:

- The output capacitor ESR should not exceed 22 Ω
- A minimum ESR may be required, see [Table 8](#)
- It is recommended not to use below 1 mA output current because of reduced phase margin
- Use electrostatic capacitors for output capacitor values of 1 μF and above

Table 8: Minimum ESR values required

I_{REG}	C2 = 100 nF	C2 = 1 μF	C2 = 10 μF	C2 = 100 μF
1 mA	> 0 Ω	> 1.5 Ω	> 0 Ω	> 0 Ω
5 mA	> 0 Ω	> 0 Ω	> 0 Ω	> 0 Ω
10 mA	> 0 Ω	> 0 Ω	> 0 Ω	> 0 Ω
100 mA	> 0 Ω	> 0 Ω	> 0 Ω	> 0 Ω

11.3 Application circuits

The maximum output current of the regulator equals:

$$I_{REG(max)} = \frac{150 - T_{amb}}{R_{th(j-a)} \times (V_P - V_{REG})} = \frac{150 - T_{amb}}{100 \times (V_P - 3.3)} (mA)$$

When $T_{amb} = 21\text{ }^{\circ}\text{C}$, the maximum output current equals 116 mA at $V_P = 14\text{ V}$.

For successful operation of the IC (maximum output current capability) special attention has to be given to the copper area required as heatsink (connected to all GND pins), the thermal capacity of the heatsink and its ability to transfer heat to the external environment. It is possible to reduce the total thermal resistance from 155 K/W to 30 K/W.

11.3.1 Application circuit with backup function

Sometimes, a backup function is needed to supply, for example, a microcontroller for a short period of time when the supply voltage spikes to 0 V (or even -1 V).

This function can easily be built with the TDA3673 by using a large output capacitor. When the supply voltage is 0 V (or -1 V), only a small current will flow into pin REG from this large output capacitor (a few μA).

The application circuit is given in [Figure 3](#).

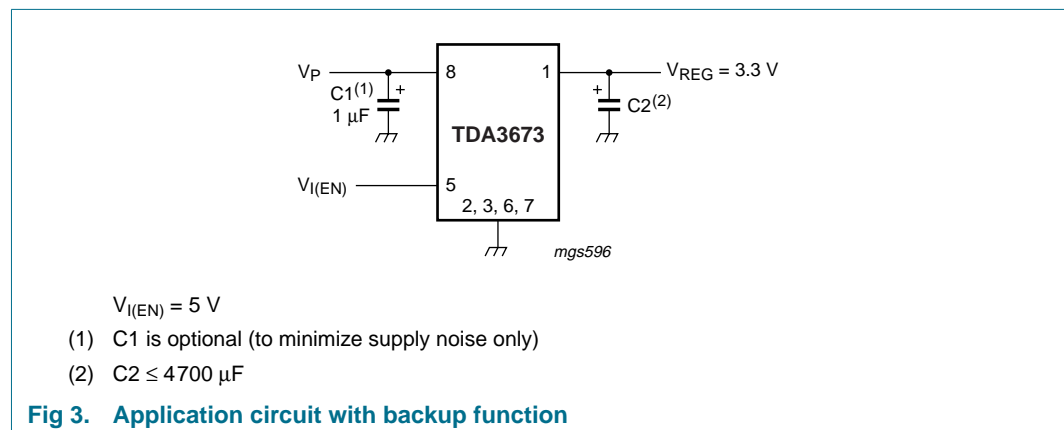

11.4 Additional application information

This section gives typical curves for various parameters measured on the TDA3673. Standard test conditions are: $V_P = 14.4\text{ V}$; $T_{\text{amb}} = 25\text{ }^\circ\text{C}$.

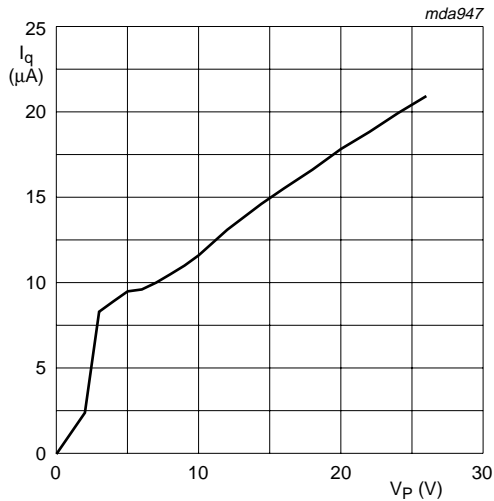

Fig 4. Quiescent current as a function of the supply voltage

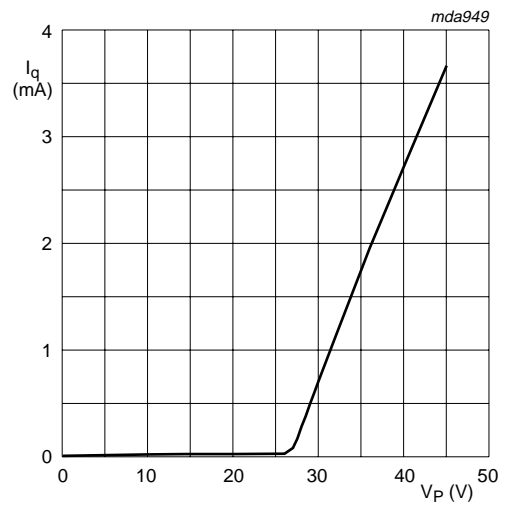

Fig 5. Quiescent current as a function of high supply voltage

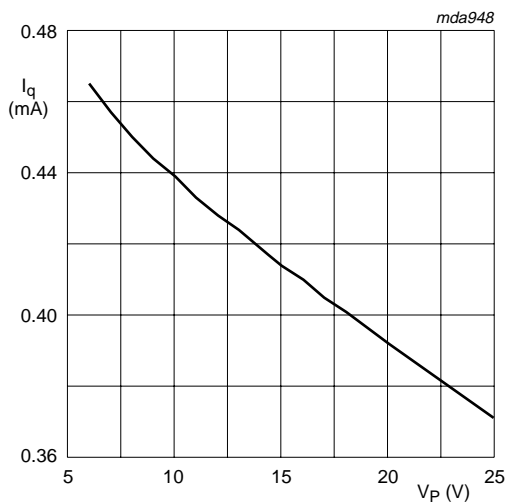

Fig 6. Quiescent current as a function of the supply voltage

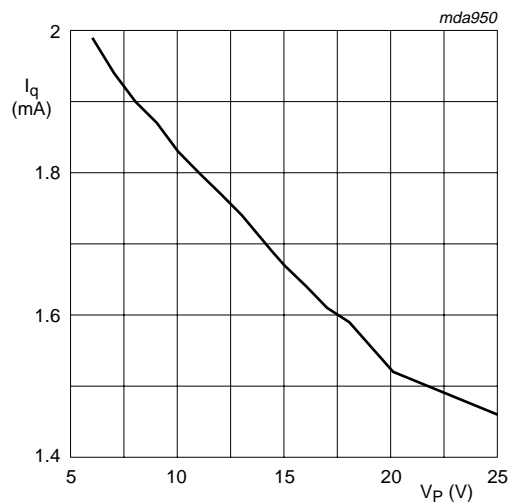
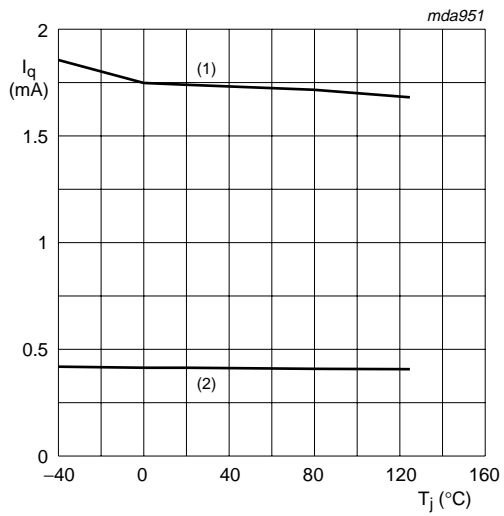

Fig 7. Quiescent current as a function of the supply voltage



- (1) I_q at 50 mA load
- (2) I_q at 10 mA load

Fig 8. Quiescent current as a function of the junction temperature.

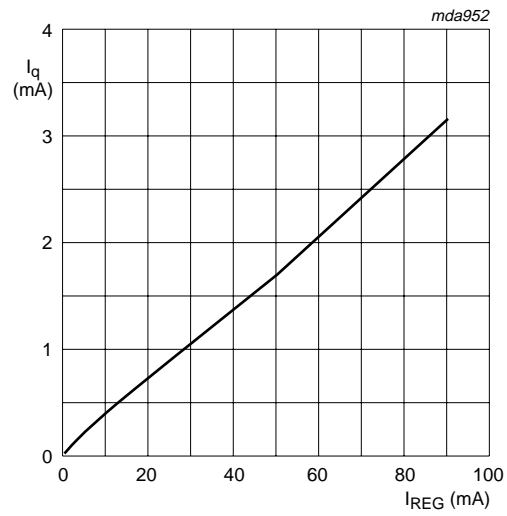
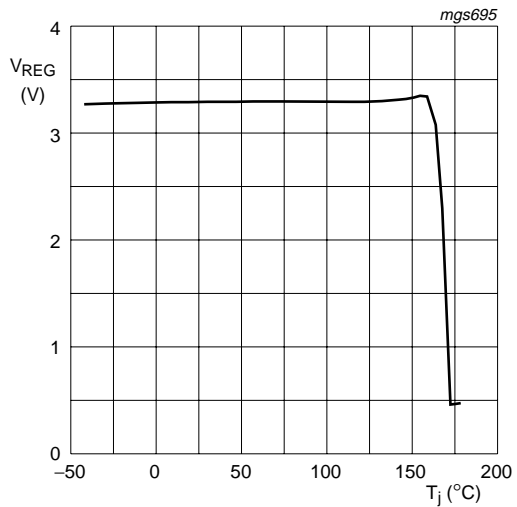

Fig 9. Quiescent current as a function of the output current



$I_{REG} = 0$ mA

Fig 10. Output voltage thermal protection as a function of the junction temperature

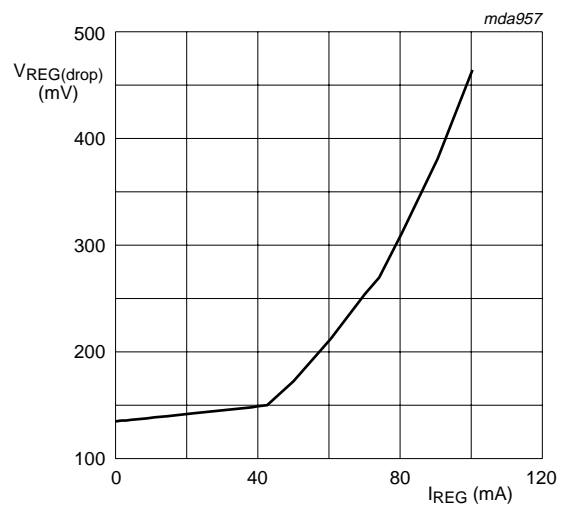
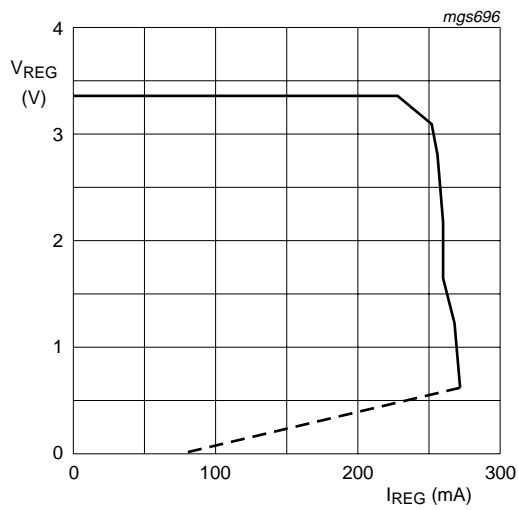
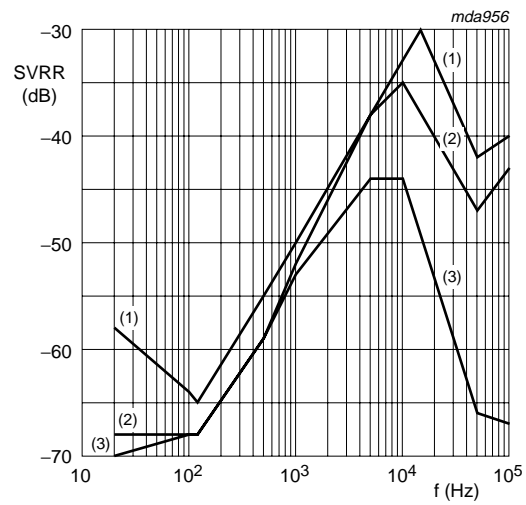

Fig 11. Dropout voltage as a function of the output current



$V_P = 8\text{ V}$; pulsed load.

Fig 12. Foldback protection mode



$I_{REG} = 10\text{ mA}$; $C_2 = 10\text{ }\mu\text{F}$

- (1) SVRR at $R_L = 100\text{ }\Omega$
- (2) SVRR at $R_L = 500\text{ }\Omega$.
- (3) SVRR at $R_L = 10\text{ k}\Omega$.

Fig 13. Supply voltage ripple rejection as a function of the ripple frequency

12. Test information

12.1 Quality information

The *General Quality Specification for Integrated Circuits, SNW-FQ-611* is applicable.

12.2 Test circuit

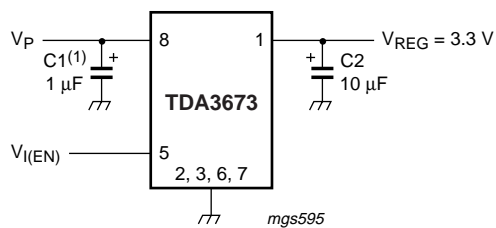

$V_{I(EN)} = 5\text{ V}$

- (1) C1 is optional (to minimize supply noise only)

Fig 14. Test circuit

13. Package outline

SO8: plastic small outline package; 8 leads; body width 3.9 mm

SOT96-1

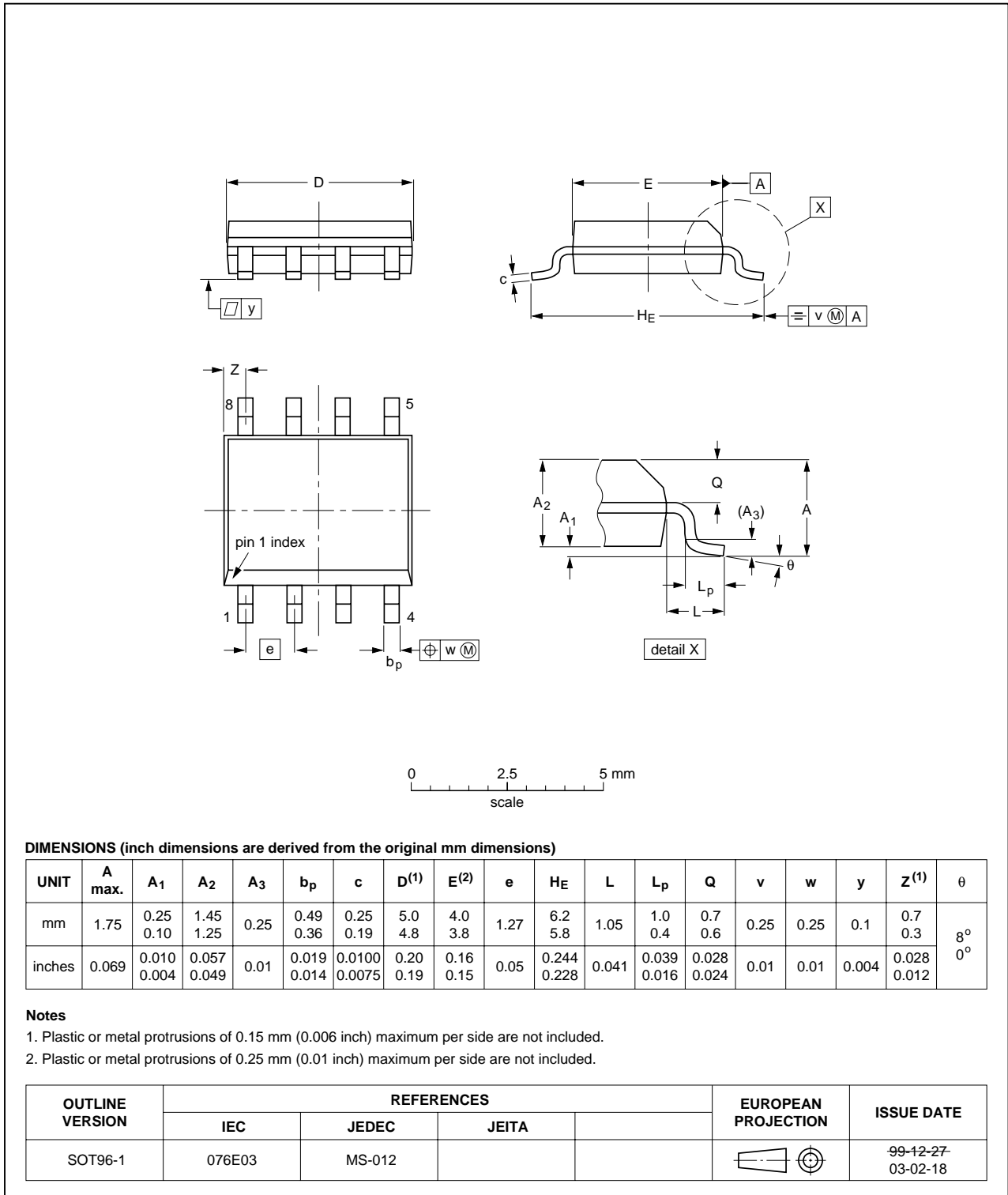

Fig 15. Package outline SOT96-1 (SO8)

14. Soldering

14.1 Introduction to soldering surface mount packages

This text gives a very brief insight to a complex technology. A more in-depth account of soldering ICs can be found in our *Data Handbook IC26; Integrated Circuit Packages* (document order number 9398 652 90011).

There is no soldering method that is ideal for all surface mount IC packages. Wave soldering can still be used for certain surface mount ICs, but it is not suitable for fine pitch SMDs. In these situations reflow soldering is recommended.

14.2 Reflow soldering

Reflow soldering requires solder paste (a suspension of fine solder particles, flux and binding agent) to be applied to the printed-circuit board by screen printing, stencilling or pressure-syringe dispensing before package placement. Driven by legislation and environmental forces the worldwide use of lead-free solder pastes is increasing.

Several methods exist for reflowing; for example, convection or convection/infrared heating in a conveyor type oven. Throughput times (preheating, soldering and cooling) vary between 100 seconds and 200 seconds depending on heating method.

Typical reflow peak temperatures range from 215 °C to 270 °C depending on solder paste material. The top-surface temperature of the packages should preferably be kept:

- below 225 °C (SnPb process) or below 245 °C (Pb-free process)
 - for all BGA, HTSSON..T and SSOP..T packages
 - for packages with a thickness ≥ 2.5 mm
 - for packages with a thickness < 2.5 mm and a volume ≥ 350 mm³ so called thick/large packages.
- below 240 °C (SnPb process) or below 260 °C (Pb-free process) for packages with a thickness < 2.5 mm and a volume < 350 mm³ so called small/thin packages.

Moisture sensitivity precautions, as indicated on packing, must be respected at all times.

14.3 Wave soldering

Conventional single wave soldering is not recommended for surface mount devices (SMDs) or printed-circuit boards with a high component density, as solder bridging and non-wetting can present major problems.

To overcome these problems the double-wave soldering method was specifically developed.

If wave soldering is used the following conditions must be observed for optimal results:

- Use a double-wave soldering method comprising a turbulent wave with high upward pressure followed by a smooth laminar wave.
- For packages with leads on two sides and a pitch (e):
 - larger than or equal to 1.27 mm, the footprint longitudinal axis is **preferred** to be parallel to the transport direction of the printed-circuit board;

- smaller than 1.27 mm, the footprint longitudinal axis **must** be parallel to the transport direction of the printed-circuit board.

The footprint must incorporate solder thieves at the downstream end.

- For packages with leads on four sides, the footprint must be placed at a 45° angle to the transport direction of the printed-circuit board. The footprint must incorporate solder thieves downstream and at the side corners.

During placement and before soldering, the package must be fixed with a droplet of adhesive. The adhesive can be applied by screen printing, pin transfer or syringe dispensing. The package can be soldered after the adhesive is cured.

Typical dwell time of the leads in the wave ranges from 3 seconds to 4 seconds at 250 °C or 265 °C, depending on solder material applied, SnPb or Pb-free respectively.

A mildly-activated flux will eliminate the need for removal of corrosive residues in most applications.

14.4 Manual soldering

Fix the component by first soldering two diagonally-opposite end leads. Use a low voltage (24 V or less) soldering iron applied to the flat part of the lead. Contact time must be limited to 10 seconds at up to 300 °C.

When using a dedicated tool, all other leads can be soldered in one operation within 2 seconds to 5 seconds between 270 °C and 320 °C.

14.5 Package related soldering information

Table 9: Suitability of surface mount IC packages for wave and reflow soldering methods

Package [1]	Soldering method	
	Wave	Reflow [2]
BGA, HTSSON..T [3], LBGA, LFBGA, SQFP, SSOP..T [3], TFBGA, VFBGA, XSON	not suitable	suitable
DHVQFN, HBCC, HBGA, HLQFP, HSO, HSOP, HSQFP, HSSON, HTQFP, HTSSOP, HVQFN, HVSON, SMS	not suitable [4]	suitable
PLCC [5], SO, SOJ	suitable	suitable
LQFP, QFP, TQFP	not recommended [5] [6]	suitable
SSOP, TSSOP, VSO, VSSOP	not recommended [7]	suitable
CWQCCN..L [8], PMFP [9], WQCCN..L [8]	not suitable	not suitable

[1] For more detailed information on the BGA packages refer to the *(LF)BGA Application Note (AN01026)*; order a copy from your Philips Semiconductors sales office.

[2] All surface mount (SMD) packages are moisture sensitive. Depending upon the moisture content, the maximum temperature (with respect to time) and body size of the package, there is a risk that internal or external package cracks may occur due to vaporization of the moisture in them (the so called popcorn effect). For details, refer to the Drypack information in the *Data Handbook IC26; Integrated Circuit Packages; Section: Packing Methods*.

[3] These transparent plastic packages are extremely sensitive to reflow soldering conditions and must on no account be processed through more than one soldering cycle or subjected to infrared reflow soldering with peak temperature exceeding 217 °C ± 10 °C measured in the atmosphere of the reflow oven. The package body peak temperature must be kept as low as possible.

- [4] These packages are not suitable for wave soldering. On versions with the heatsink on the bottom side, the solder cannot penetrate between the printed-circuit board and the heatsink. On versions with the heatsink on the top side, the solder might be deposited on the heatsink surface.
- [5] If wave soldering is considered, then the package must be placed at a 45° angle to the solder wave direction. The package footprint must incorporate solder thieves downstream and at the side corners.
- [6] Wave soldering is suitable for LQFP, QFP and TQFP packages with a pitch (e) larger than 0.8 mm; it is definitely not suitable for packages with a pitch (e) equal to or smaller than 0.65 mm.
- [7] Wave soldering is suitable for SSOP, TSSOP, VSO and VSSOP packages with a pitch (e) equal to or larger than 0.65 mm; it is definitely not suitable for packages with a pitch (e) equal to or smaller than 0.5 mm.
- [8] Image sensor packages in principle should not be soldered. They are mounted in sockets or delivered pre-mounted on flex foil. However, the image sensor package can be mounted by the client on a flex foil by using a hot bar soldering process. The appropriate soldering profile can be provided on request.
- [9] Hot bar soldering or manual soldering is suitable for PMFP packages.

15. Revision history

Table 10: Revision history

Document ID	Release date	Data sheet status	Change notice	Doc. number	Supersedes
TDA3673_5	20050610	Product data sheet	-	9397 750 15051	TDA3673_4
Modifications:					
			<ul style="list-style-type: none"> The format of this data sheet has been redesigned to comply with the new presentation and information standard of Philips Semiconductors. Section 2 "Features": removed some items. Section 7 "Functional description": changed. Table 5 "Thermal characteristics": changed typical value from 125 K/W to 155 K/W. Section 11.2 "Stability": changed text, removed figures and all examples. Section 11.3 "Application circuits": changed last sentence..."from 120 K/W to 50 K/W" to "...from 155 K/W to 30 K/W". Section 11.4 "Additional application information": changed and removed one figure. 		
TDA3673_4	20001214	Product specification	-	9397 750 07867	TDA3673_3
TDA3673_3	20001208	Preliminary specification	-	9397 750 07557	TDA3673_2
TDA3673_2	20000201	Preliminary specification	-	9397 750 06801	TDA3673_1
TDA3673_1	19990929	Preliminary specification	-	9397 750 06071	-

16. Data sheet status

Level	Data sheet status ^[1]	Product status ^{[2] [3]}	Definition
I	Objective data	Development	This data sheet contains data from the objective specification for product development. Philips Semiconductors reserves the right to change the specification in any manner without notice.
II	Preliminary data	Qualification	This data sheet contains data from the preliminary specification. Supplementary data will be published at a later date. Philips Semiconductors reserves the right to change the specification without notice, in order to improve the design and supply the best possible product.
III	Product data	Production	This data sheet contains data from the product specification. Philips Semiconductors reserves the right to make changes at any time in order to improve the design, manufacturing and supply. Relevant changes will be communicated via a Customer Product/Process Change Notification (CPCN).

[1] Please consult the most recently issued data sheet before initiating or completing a design.

[2] The product status of the device(s) described in this data sheet may have changed since this data sheet was published. The latest information is available on the Internet at URL <http://www.semiconductors.philips.com>.

[3] For data sheets describing multiple type numbers, the highest-level product status determines the data sheet status.

17. Definitions

Short-form specification — The data in a short-form specification is extracted from a full data sheet with the same type number and title. For detailed information see the relevant data sheet or data handbook.

Limiting values definition — Limiting values given are in accordance with the Absolute Maximum Rating System (IEC 60134). Stress above one or more of the limiting values may cause permanent damage to the device. These are stress ratings only and operation of the device at these or at any other conditions above those given in the Characteristics sections of the specification is not implied. Exposure to limiting values for extended periods may affect device reliability.

Application information — Applications that are described herein for any of these products are for illustrative purposes only. Philips Semiconductors make no representation or warranty that such applications will be suitable for the specified use without further testing or modification.

18. Disclaimers

Life support — These products are not designed for use in life support appliances, devices, or systems where malfunction of these products can reasonably be expected to result in personal injury. Philips Semiconductors

20. Contact information

For additional information, please visit: <http://www.semiconductors.philips.com>

For sales office addresses, send an email to: sales.addresses@www.semiconductors.philips.com

customers using or selling these products for use in such applications do so at their own risk and agree to fully indemnify Philips Semiconductors for any damages resulting from such application.

Right to make changes — Philips Semiconductors reserves the right to make changes in the products - including circuits, standard cells, and/or software - described or contained herein in order to improve design and/or performance. When the product is in full production (status 'Production'), relevant changes will be communicated via a Customer Product/Process Change Notification (CPCN). Philips Semiconductors assumes no responsibility or liability for the use of any of these products, conveys no license or title under any patent, copyright, or mask work right to these products, and makes no representations or warranties that these products are free from patent, copyright, or mask work right infringement, unless otherwise specified.

19. Trademarks

Notice — All referenced brands, product names, service names and trademarks are the property of their respective owners.

21. Contents

1	General description	1
2	Features	1
3	Quick reference data	1
4	Ordering information	2
5	Block diagram	2
6	Pinning information	3
6.1	Pinning	3
6.2	Pin description	3
7	Functional description	3
8	Limiting values	4
9	Thermal characteristics	4
10	Characteristics	4
11	Application information	5
11.1	Noise	5
11.2	Stability	5
11.3	Application circuits	6
11.3.1	Application circuit with backup function	6
11.4	Additional application information	7
12	Test information	9
12.1	Quality information	9
12.2	Test circuit	9
13	Package outline	10
14	Soldering	11
14.1	Introduction to soldering surface mount packages	11
14.2	Reflow soldering	11
14.3	Wave soldering	11
14.4	Manual soldering	12
14.5	Package related soldering information	12
15	Revision history	14
16	Data sheet status	15
17	Definitions	15
18	Disclaimers	15
19	Trademarks	15
20	Contact information	15



© Koninklijke Philips Electronics N.V. 2005

All rights are reserved. Reproduction in whole or in part is prohibited without the prior written consent of the copyright owner. The information presented in this document does not form part of any quotation or contract, is believed to be accurate and reliable and may be changed without notice. No liability will be accepted by the publisher for any consequence of its use. Publication thereof does not convey nor imply any license under patent- or other industrial or intellectual property rights.

Date of release: 10 June 2005
Document number: 9397 750 15051

Published in The Netherlands