



RF Power LDMOS Transistor

High Ruggedness N-Channel Enhancement-Mode Lateral MOSFET

This RF power transistor is designed for short pulse applications operating at frequencies from 850 to 950 MHz.

Typical Performance: $V_{DD} = 50 \text{ Vdc}$, $I_{DQ(A+B)} = 100 \text{ mA}$

Frequency (MHz)	Signal Type	P_{out} (W)	G_{ps} (dB)	η_D (%)
950	Pulse (100 μsec , 20% Duty Cycle)	1050 Peak	21.3	63.7

Load Mismatch/Ruggedness

Frequency (MHz)	Signal Type	VSWR	P_{in} (W)	Test Voltage	Result
950	Pulse (100 μsec , 20% Duty Cycle)	> 20:1 at all Phase Angles	15 W Peak (3 dB Overdrive)	50	No Device Degradation

Features

- Internally input and output matched for broadband operation and ease of use
- Device can be used in a single-ended, push-pull or quadrature configuration
- Qualified up to 50 V
- High ruggedness, handles > 20:1 VSWR
- Integrated ESD protection with greater negative voltage range for improved Class C operation and gate voltage pulsing
- Characterized with series equivalent large-signal impedance parameters

Typical Applications

- Land- or sea-based UHF radar

MMRF1050H

850–950 MHz, 1050 W PEAK, 50 V RF POWER LDMOS TRANSISTOR

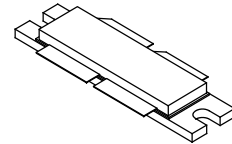

NI-1230H-4S

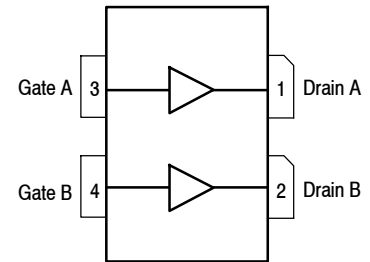

(Top View)

Note: The backside of the package is the source terminal for the transistor.

Figure 1. Pin Connections

Table 1. Maximum Ratings

Rating	Symbol	Value	Unit
Drain-Source Voltage	V_{DSS}	-0.5, +105	Vdc
Gate-Source Voltage	V_{GS}	-6.0, +10	Vdc
Storage Temperature Range	T_{stg}	-65 to +150	°C
Case Operating Temperature Range	T_C	-55 to 150	°C
Operating Junction Temperature Range (1,2)	T_J	-55 to 225	°C

Table 2. Thermal Characteristics

Characteristic	Symbol	Value (2,3)	Unit
Thermal Impedance, Junction to Case Pulse: Case Temperature 87°C, 1050 W Peak, 100 μ sec Pulse Width, 20% Duty Cycle, 50 Vdc, $I_{DQ(A+B)} = 100$ mA, 950 MHz	$Z_{\theta JC}$	0.034	°C/W

Table 3. ESD Protection Characteristics

Test Methodology	Class
Human Body Model (per JS-001-2017)	2, passes 2500 V
Charge Device Model (per JS-002-2014)	C3, passes 1000 V

Table 4. Electrical Characteristics ($T_A = 25^\circ\text{C}$ unless otherwise noted)

Characteristic	Symbol	Min	Typ	Max	Unit
----------------	--------	-----	-----	-----	------

Off Characteristics (4)

Gate-Source Leakage Current ($V_{GS} = 5$ Vdc, $V_{DS} = 0$ Vdc)	I_{GSS}	—	—	1	μ Adc
Drain-Source Breakdown Voltage ($V_{GS} = 0$ Vdc, $I_D = 10$ μ A)	$V_{(BR)DSS}$	105	—	—	Vdc
Zero Gate Voltage Drain Leakage Current ($V_{DS} = 50$ Vdc, $V_{GS} = 0$ Vdc)	I_{DSS}	—	—	1	μ Adc
Zero Gate Voltage Drain Leakage Current ($V_{DS} = 105$ Vdc, $V_{GS} = 0$ Vdc)	I_{DSS}	—	—	10	μ Adc

On Characteristics

Gate Threshold Voltage (4) ($V_{DS} = 10$ Vdc, $I_D = 396$ μ Adc)	$V_{GS(th)}$	1.3	1.7	2.3	Vdc
Gate Quiescent Voltage (5) ($V_{DD} = 50$ Vdc, $I_{DQ(A+B)} = 100$ mAdc, Measured in Functional Test)	$V_{GS(Q)}$	1.7	2.0	2.3	Vdc
Drain-Source On-Voltage (4) ($V_{GS} = 10$ Vdc, $I_D = 1.98$ Adc)	$V_{DS(on)}$	0.05	0.14	0.35	Vdc

Dynamic Characteristics (4)

Reverse Transfer Capacitance ($V_{DS} = 50$ Vdc \pm 30 mV(rms)ac @ 1 MHz, $V_{GS} = 0$ Vdc)	C_{rss}	—	1.85	—	pF
---	-----------	---	------	---	----

1. Continuous use at maximum temperature will affect MTTF.
2. MTTF calculator available at <http://www.nxp.com>.
3. Refer to AN1955, *Thermal Measurement Methodology of RF Power Amplifiers*. Go to <http://www.nxp.com/RF> and search for AN1955.
4. Each side of device measured separately.
5. Measurement made with device in push-pull configuration.

(continued)

Table 4. Electrical Characteristics ($T_A = 25^\circ\text{C}$ unless otherwise noted) (continued)

Characteristic	Symbol	Min	Typ	Max	Unit
Functional Tests ⁽¹⁾ (In NXP Production Test Fixture, 50 ohm system) $V_{DD} = 50\text{ Vdc}$, $I_{DQ(A+B)} = 100\text{ mA}$, $P_{out} = 1050\text{ W Peak}$ (210 W Avg.), $f = 950\text{ MHz}$, 100 μsec Pulse Width, 20% Duty Cycle					
Power Gain	G_{ps}	19.0	21.3	23.5	dB
Drain Efficiency	η_D	57.0	63.7	—	%
Input Return Loss	IRL	—	-18.5	-9.0	dB

Table 5. Load Mismatch/Ruggedness (In NXP Production Test Fixture, 50 ohm system) $I_{DQ(A+B)} = 100\text{ mA}$

Frequency (MHz)	Signal Type	VSWR	P_{in} (W)	Test Voltage, V_{DD}	Result
950	Pulse (100 μsec , 20% Duty Cycle)	> 20:1 at all Phase Angles	15 W Peak (3 dB Overdrive)	50	No Device Degradation

Table 6. Ordering Information

Device	Tape and Reel Information	Package
MMRF1050HR6	R6 Suffix = 150 Units, 56 mm Tape Width, 13-inch Reel	NI-1230H-4S

1. Measurement made with device in push-pull configuration.

TYPICAL CHARACTERISTICS

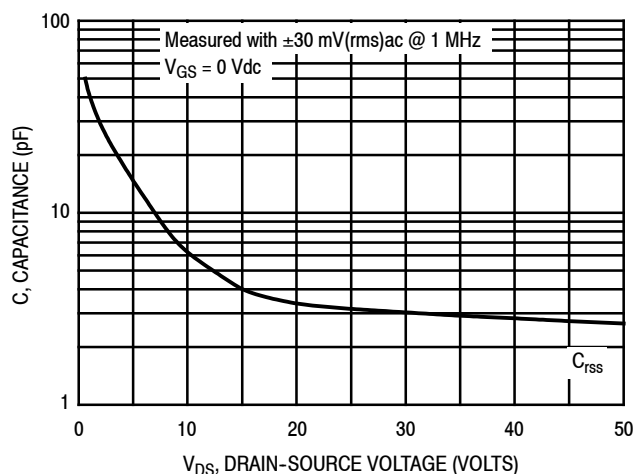

Note: Each side of device measured separately.

Figure 2. Capacitance versus Drain-Source Voltage

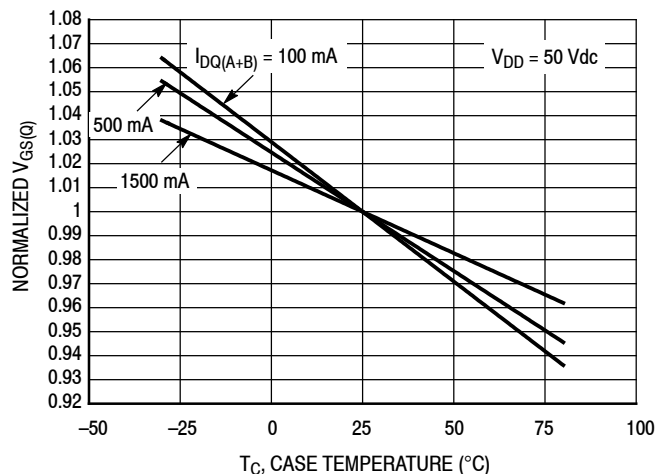

I_{DQ} (mA)	Slope (mV/°C)
100	-2.36
500	-2.26
1500	-1.84

Figure 3. Normalized V_{GS} versus Quiescent Current and Case Temperature

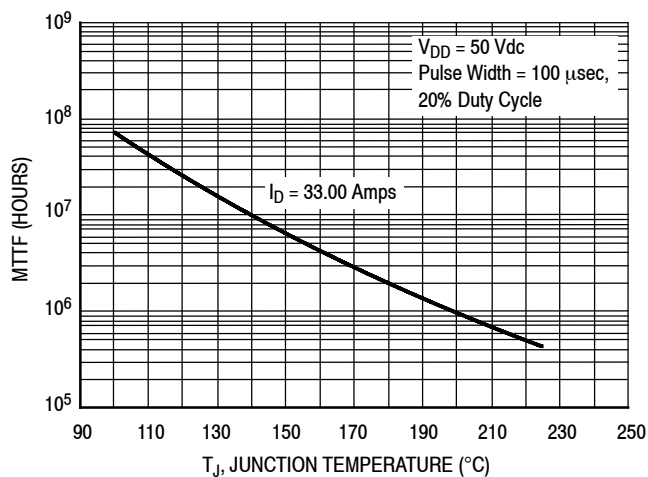

Note: MTTF value represents the total cumulative operating time under indicated test conditions.

MTTF calculator available at <http://www.nxp.com>.

Figure 4. MTTF versus Junction Temperature — Pulse

950 MHz PRODUCTION FIXTURE — 4" x 5" (10.2 cm x 12.7 cm)

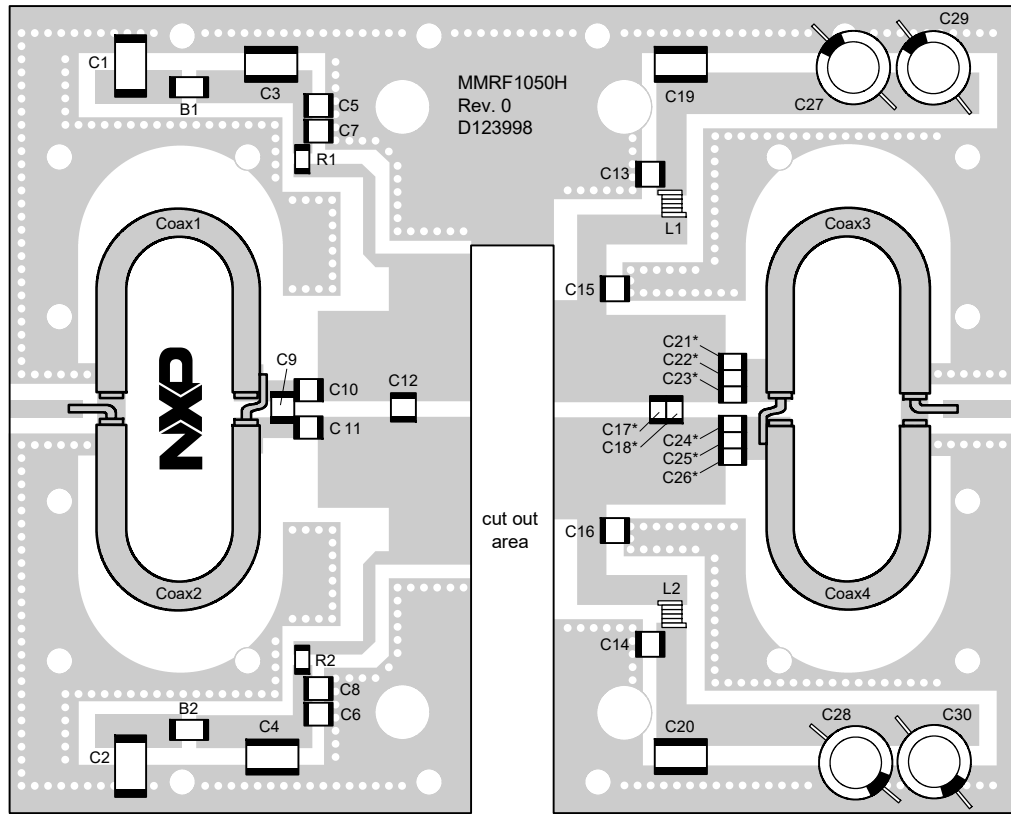

* C17, C18, C21, C22, C23, C24, C25 and C26 are mounted vertically.

aaa-039673

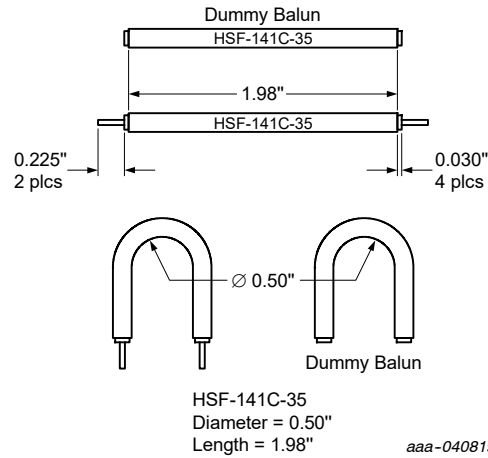

Figure 5. MMRF1050H Production Fixture Component Layout — 950 MHz

Table 7. MMRF1050H Production Fixture Component Designations and Values — 950 MHz

Part	Description	Part Number	Manufacturer
B1, B2	Short RF Bead	2743019447	Fair-Rite
C1, C2	22 μ F, 35 V Tantalum Capacitor	T491X226K035AS	Kemet
C3, C4	2.2 μ F Chip Capacitor	C1825C225J5RACTU	Kemet
C5, C6	0.1 μ F Chip Capacitor	CDR33BX104AKWS	AVX
C7, C8, C13, C14	36 pF Chip Capacitor	100B360JT500XT	ATC
C9	2.7 pF Chip Capacitor	100B2R7BT500XT	ATC
C10, C11	30 pF Chip Capacitor	100B300JT500XT	ATC
C12	6.2 pF Chip Capacitor	100B6R2BT500XT	ATC
C15, C16	8.2 pF Chip Capacitor	100B8R2CT500XT	ATC
C17, C18	4.7 pF Chip Capacitor	100B4R7CT500XT	ATC
C19, C20	0.01 μ F Chip Capacitor	C1825C103K1GAC-TU	Kemet
C21, C22, C23, C24, C25, C26	43 pF Chip Capacitor	100B430JT500XT	ATC
C27, C28, C29, C30	470 μ F, 63 V Electrolytic Capacitor	MCGPR63V477M13X26	Multicomp
Coax1, 2, 3, 4	35 Ω Semirigid Coax Cable, 1.98" Shield Length	HSF-141C-35	Hangzhou Hongsen
L1, L2	12 nH, 3 Turn Inductor	GA3094-ALC	Coilcraft
Q1	RF Power LDMOS Transistor	MMRF1050H	NXP
R1, R2	1000 Ω , 1/4 W Chip Resistor	CRCW12061K00FKEA	Vishay
PCB	Arlon 450 0.030", $\epsilon_r = 2.55$, 2 oz. Copper	D123998	MTL

**TYPICAL CHARACTERISTICS — 950 MHz, $T_C = 25^\circ\text{C}$
PRODUCTION TEST FIXTURE**

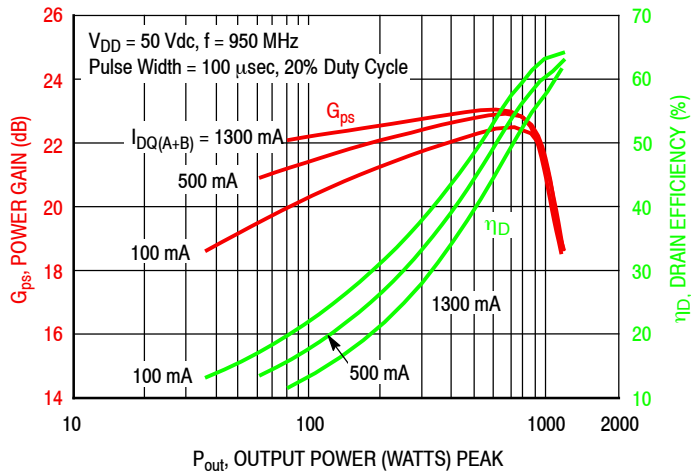

Figure 6. Power Gain and Drain Efficiency versus Output Power and Quiescent Current

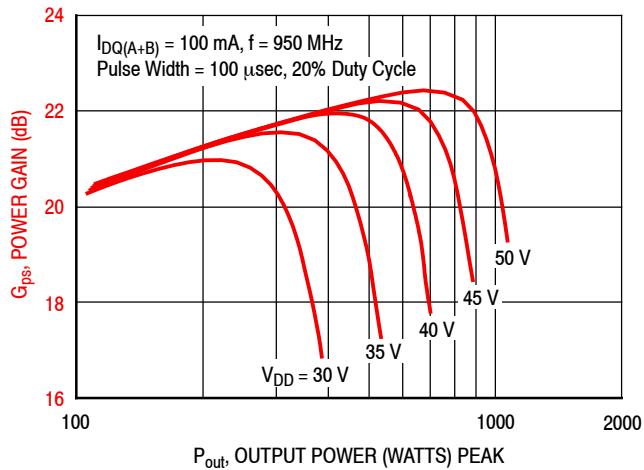

Figure 7. Power Gain versus Output Power and Drain-Source Voltage

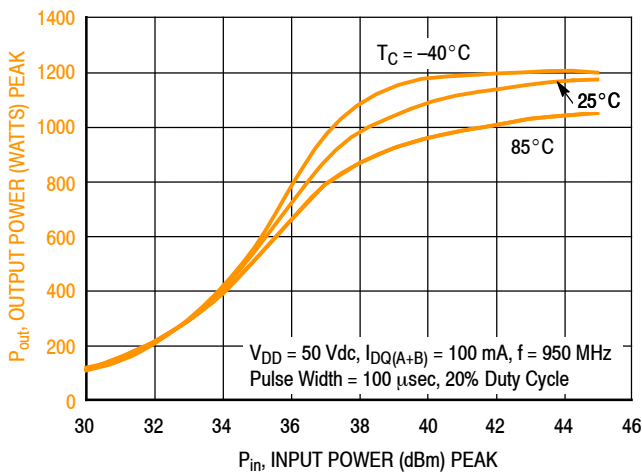

Figure 8. Output Power versus Input Power over Temperature

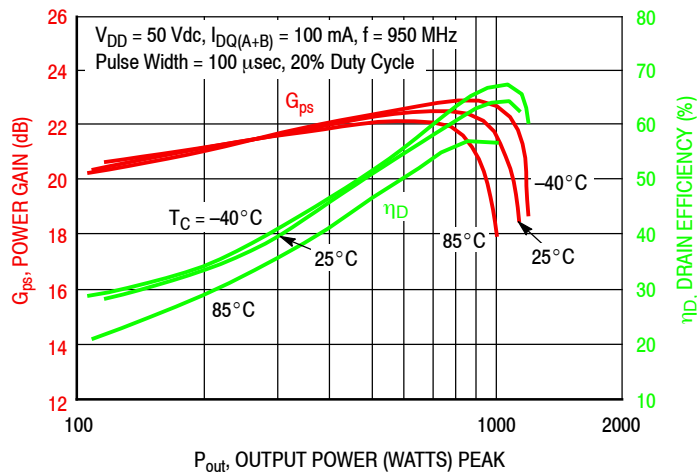

Figure 9. Power Gain and Drain Efficiency versus Output Power over Temperature

PRODUCTION FIXTURE

Band-Specific Optimized Performance and Impedance Information ($T_C = 25^\circ\text{C}$)

The measured input and output impedances are presented to the input of the device at the package reference plane. Measurements are performed in NXP optimally tuned fixtures in the frequency ranges of 850 and 950 MHz.

f (MHz)	Z_{source} (Ω)	Z_{load} (Ω)
850	$3.0 - j3.1$	$4.3 - j2.0$
950	$6.2 - j2.9$	$4.0 - j1.1$

Z_{source} = Test circuit impedance as measured from gate to gate.

Z_{load} = Test circuit impedance as measured from drain to drain.

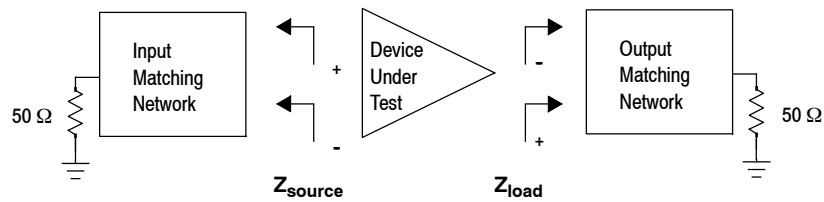
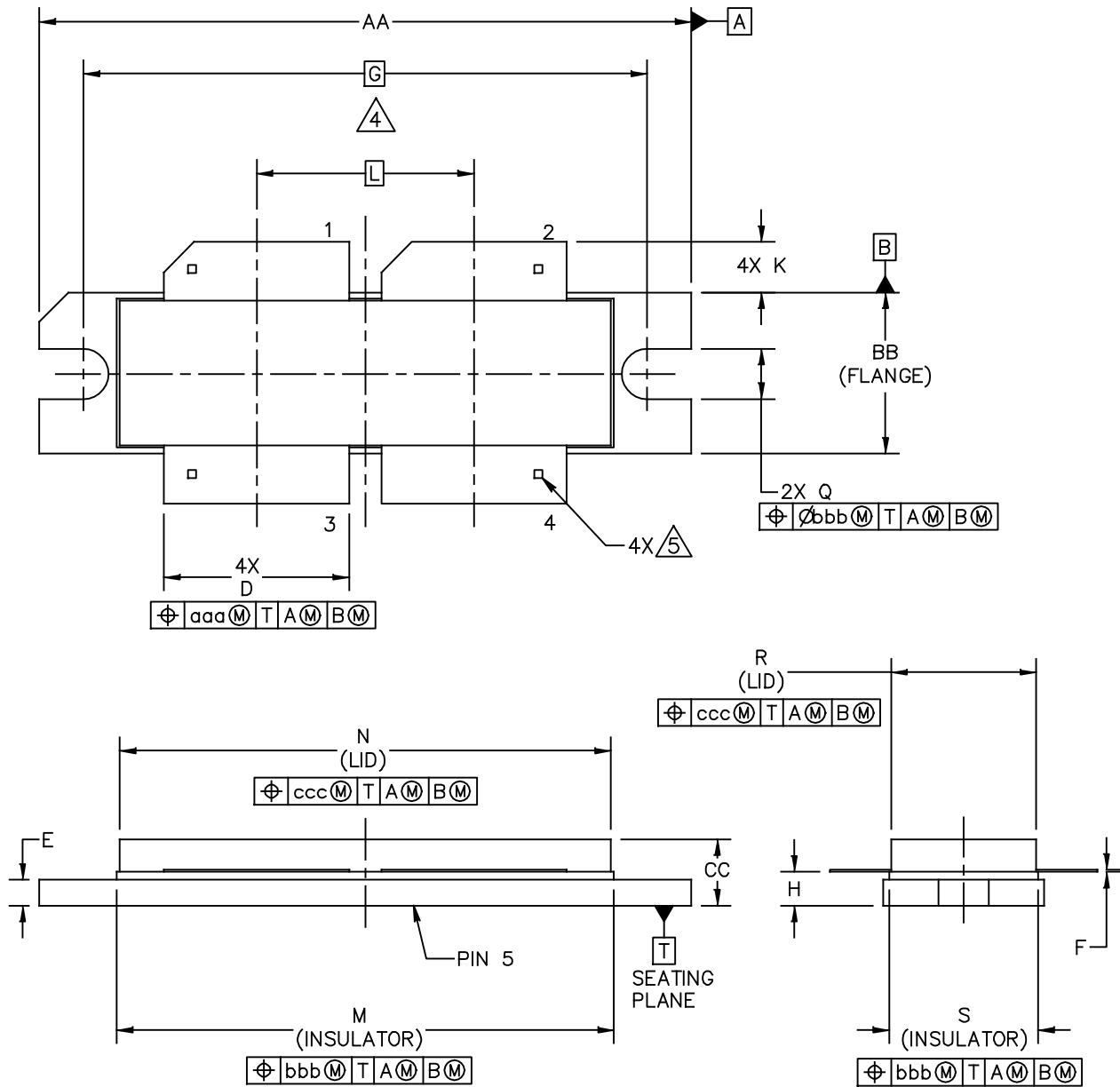

Figure 10. Series Equivalent Source and Load Impedance

PACKAGE INFORMATION

H-CFM-F-5 I/O 41.15 X 10.16 X 4.575 PKG, 13.72 PITCH - 4S
 NI-1230H-4S

SOT1787-1



© NXP B.V. ALL RIGHTS RESERVED

DATE: 25 OCT 2019

MECHANICAL OUTLINE PRINT VERSION NOT TO SCALE	STANDARD: NON JEDEC	DRAWING NUMBER: 98ASB16977C	REVISION: H	PAGE: 1 OF 2
--	------------------------	--------------------------------	----------------	-----------------

MMRF1050H

NOTES:

1. INTERPRET DIMENSIONS AND TOLERANCES PER ASME Y14.5M-1994.
2. CONTROLLING DIMENSION: INCH
3. DIMENSION H IS MEASURED .030 INCH (0.762 MM) AWAY FROM THE FLANGE TO CLEAR THE EPOXY FLOW OUT REGION PARALLEL TO DATUM B.
4. RECOMMENDED BOLT CENTER DIMENSION OF 1.52 INCH (38.61 MM) BASED ON M3 SCREW.
5. FIDUCIALS ARE OPTIONAL ON PINS 3 & 4.

DIM	INCH		MILLIMETER		DIM	INCH		MILLIMETER	
	MIN	MAX	MIN	MAX		MIN	MAX	MIN	MAX
AA	1.615	1.625	41.02	41.28	N	1.218	1.242	30.94	31.55
BB	.395	.405	10.03	10.29	Q	.120	.130	3.05	3.30
CC	.170	.190	4.32	4.83	R	.355	.365	9.02	9.27
D	.455	.465	11.56	11.81	S	.365	.375	9.27	9.53
E	.062	.066	1.57	1.68					
F	.004	.007	0.10	0.18					
G	1.400 BSC		35.56 BSC		aaa	.013		0.33	
H	.082	.090	2.08	2.29	bbb	.010		0.25	
K	.117	.137	2.97	3.48	ccc	.020		0.51	
L	.540 BSC		13.72 BSC						
M	1.219	1.241	30.96	31.52					

© NXP B.V. ALL RIGHTS RESERVED

DATE: 25 OCT 2019

MECHANICAL OUTLINE PRINT VERSION NOT TO SCALE	STANDARD: NON JEDEC	DRAWING NUMBER: 98ASB16977C	REVISION: H	PAGE: 2
--	------------------------	--------------------------------	----------------	------------

PRODUCT DOCUMENTATION, SOFTWARE AND TOOLS

Refer to the following resources to aid your design process.

Application Notes

- AN1908: Solder Reflow Attach Method for High Power RF Devices in Air Cavity Packages
- AN1955: Thermal Measurement Methodology of RF Power Amplifiers

Engineering Bulletins

- EB212: Using Data Sheet Impedances for RF LDMOS Devices

Software

- Electromigration MTTF Calculator
- .s2p File

Development Tools

- Printed Circuit Boards

REVISION HISTORY

The following table summarizes revisions to this document.

Revision	Date	Description
0	Feb. 2021	<ul style="list-style-type: none">• Initial release of data sheet

How to Reach Us:

Home Page:
nxp.com

Web Support:
nxp.com/support

Information in this document is provided solely to enable system and software implementers to use NXP products. There are no express or implied copyright licenses granted hereunder to design or fabricate any integrated circuits based on the information in this document. NXP reserves the right to make changes without further notice to any products herein.

NXP makes no warranty, representation, or guarantee regarding the suitability of its products for any particular purpose, nor does NXP assume any liability arising out of the application or use of any product or circuit, and specifically disclaims any and all liability, including without limitation consequential or incidental damages. "Typical" parameters that may be provided in NXP data sheets and/or specifications can and do vary in different applications, and actual performance may vary over time. All operating parameters, including "typicals," must be validated for each customer application by customer's technical experts. NXP does not convey any license under its patent rights nor the rights of others. NXP sells products pursuant to standard terms and conditions of sale, which can be found at the following address: nxp.com/SalesTermsandConditions.

NXP and the NXP logo are trademarks of NXP B.V. All other product or service names are the property of their respective owners.

© 2021 NXP B.V.