



Preliminary

Application Note

Audio Generation by DragonBall™ MC68EZ328 PWM Output

INTRODUCTION

This document describes an method of audio generation using DragonBall™ MC68EZ328 PWM Output. The Pulse Width Modulation (PWM) module of DragonBall™-EZ will modulate the audio signal into a pulse train of fixed periods but changing width. The changing width of the pulses corresponds to the voltage level of the sine wave.

A simple RC circuit, fourth-order low pass filter and audio amplifier are used to convert the PWM signal into audio signal. This circuit has been tested with audio sample at 16kHz and 32kHz reconstruction rate. The output sound quality is as good as an AM radio.

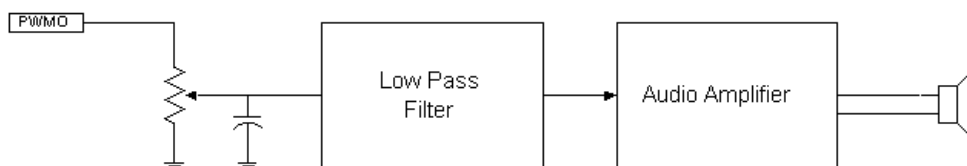

Figure 1. Block Diagram

HARDWARE

The audio generation circuit consists of a RC circuit, four-order low pass filter, audio amplifier and speaker. The RC circuit and Low Pass Filter is used for harmonics and carrier frequency generated by PWM signals. The audio amplifier will drive the speaker to generate the audio.

RC CIRCUIT

The RC circuit (Figure 2) is for attenuation and filtering harmonics of the PWM signals. It prevents the saturation of the low pass filter and the audio amplifier. After passing the signal to this RC circuit, the signal will change to a trangular wave. Figure 3 shows the ouput waveform of the RC circuit. The amplitude of each trangular wave is proportional to the value of each sample.

This document contains information on a product under development. Motorola reserves the right to change or discontinue this product without notice.

SEMICONDUCTOR PRODUCT INFORMATION

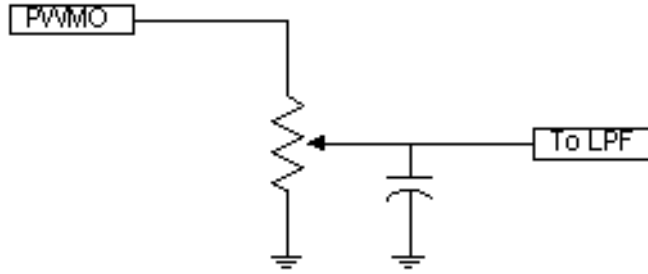

Figure 2. RC Circuit.

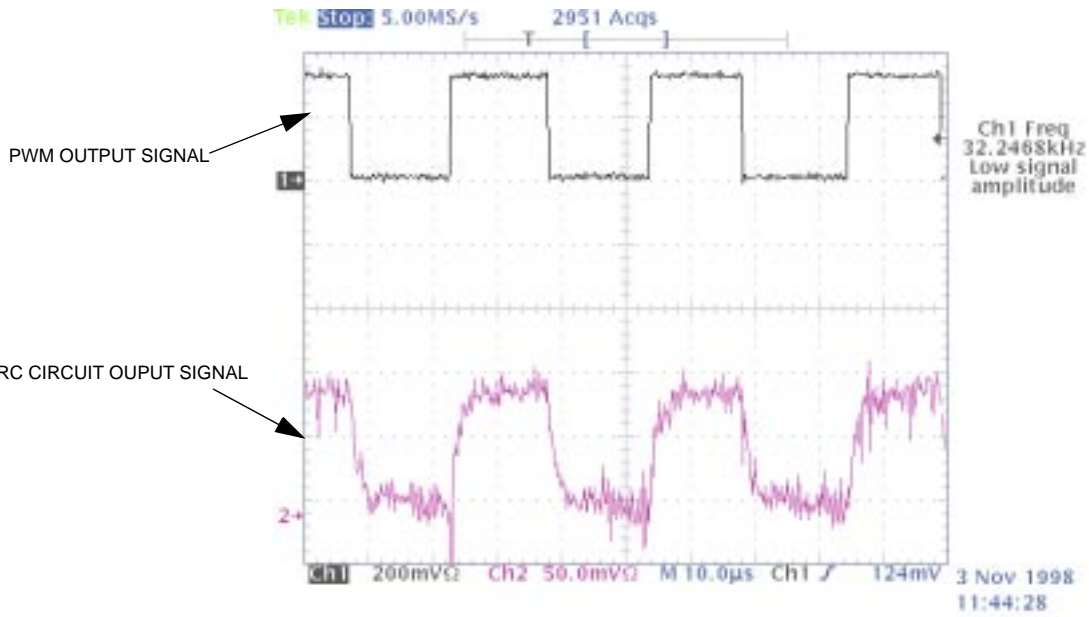

Figure 3. Output Waveform of the RC circuit.

FOURTH-ORDER LOW PASS FILTER

Figure 4 shows the schematic of the low pass filter. This four-order low pass filter is consisted of LM385 Low Power Op-Amp. It removes most of the harmonic generated by the PWM output waveform. The cut-off frequency of the circuit is about 21kHz.

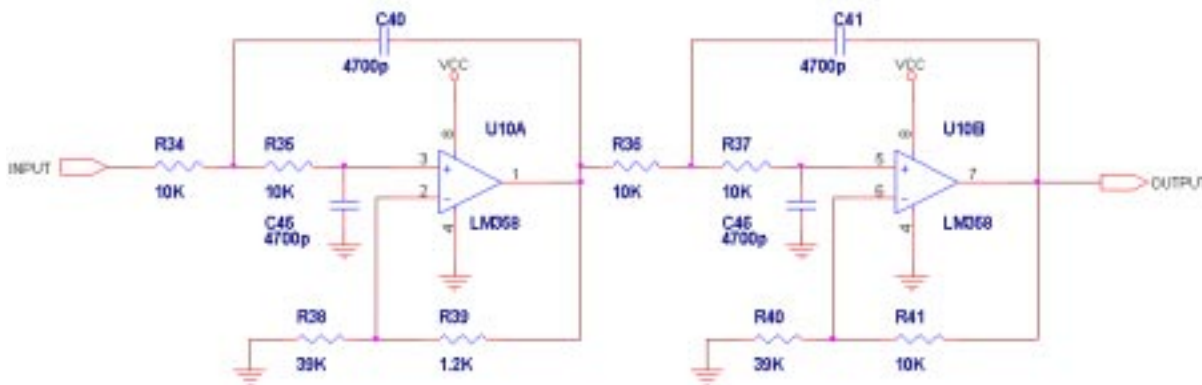

Figure 4. Fourth-order Butterworth Low Pass Filter.

AUDIO AMPLIFIER

The MC34119 Low Power Audio Amplifier is chosen for this application. This amplifier has the Chip-Disable (CD) pin, which can be set high to shut down the amplifier when it is not in use, thus minimizing the power consumption of the system.

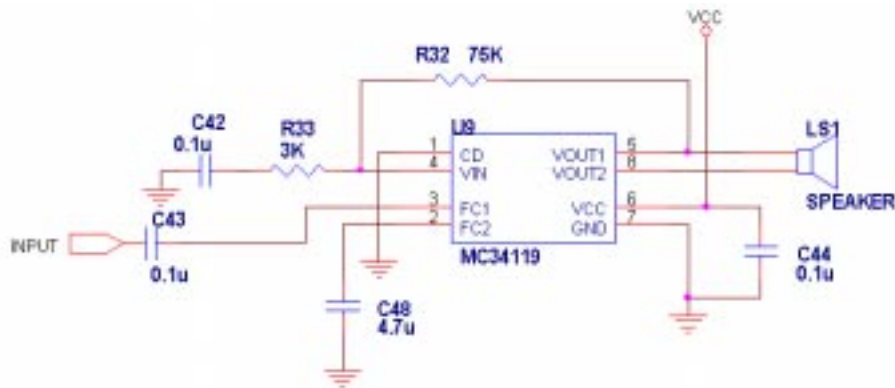

Figure 5. Audio Amplifier.

The gain of the amplifier is calculated by the following equation.

$$Gain = 2 \times \frac{R32}{R33}$$

SOFTWARE

In order to minimize the size of data storing the sound samples, the sound samples is at 8kHz sampling rate. It is because the human can heard the 8kHz carrier frequency. So, we need to set the reconstruction rate of PWM output to 32kHz and repeat the same sample to PWM output three times. Figure 6 shows the difference between the PWM output waveforms with reconstruction rate at 8kHz, 16kHz and 32kHz. The number of repetitions of each sample and reconstruction rate can be selected by changing the PWM Control Register of MC68EZ328. The DragonBall™-EZ User's Manual will describe the details of programming the PWM module. A example program will be attached with this document.

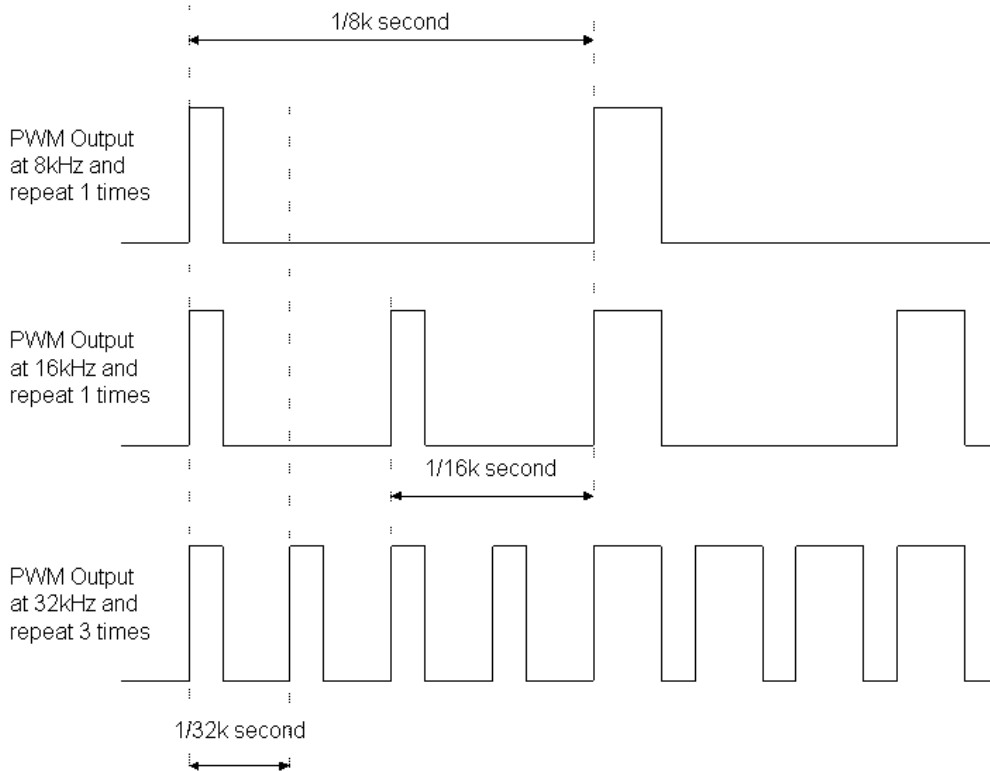

Figure 6. Waveform of PWM Output.



APPENDIX: EXAMPLE AUDIO GENERATION CIRCUIT



Audio Generation Circuit with Enable Circuit

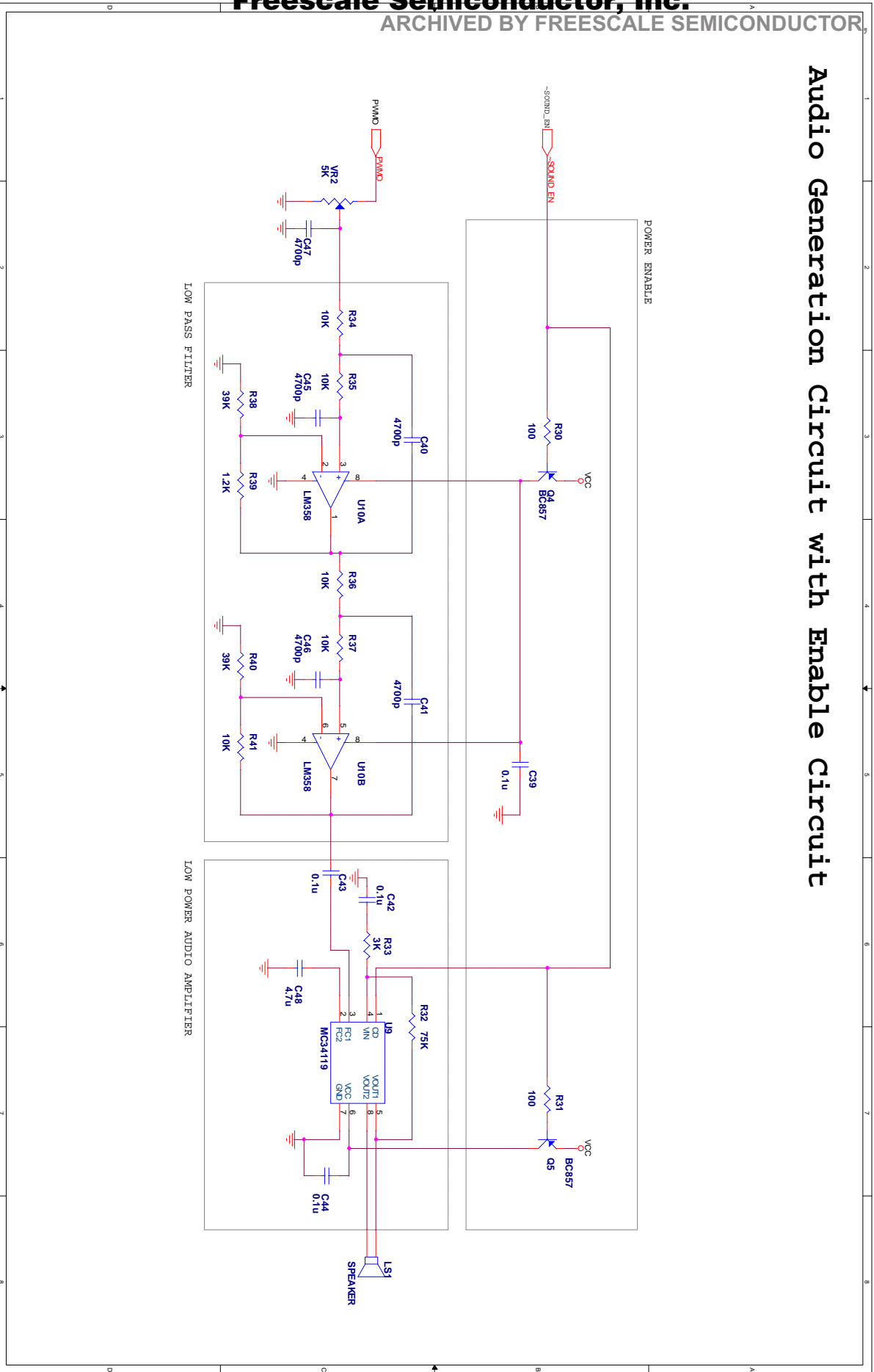



Audio Generation Circuit without Enable Circuit

