

Matching Network Designs with Computer Solutions

Prepared by: Frank Davis

INTRODUCTION

One of the problems facing the circuit design engineer is the design of high-frequency matching networks. Careful design of a network that will accomplish the required matching, harmonic attenuation, bandwidth, etc., and yield components of practical size can result in many hours spent with pencil and slide rule.

The design of matching networks for high-frequency circuits involves an infinite number of possibilities, and a complete tabulation of possible network solutions would be virtually impossible. However, it is often necessary to design matching networks with a $50 + j 0$ ohm impedance at one port. This, combined with a restricted range of impedance values to be matched, imposed by network and device limitations, makes practical a tabulation of some of the more commonly used networks. These design solutions are given in this report.

The network solutions included in this report have the limitation that one terminating impedance must be $50 + j 0$ ohms. These networks are often used for matching in transistor RF power amplifier circuits that have a 50-ohm source or load. When the network does not have a 50-ohm termination at either port, the mathematical procedure given for each network in Appendix I can be used for the solution.

COMPONENT CONSIDERATIONS

Four networks are presented in this report with solutions in the form of computer tabulations. Each network has its own limitations. Although the network configuration is normally up to the discretion of the design engineer, it is sometimes necessary to use one configuration in preference to another in order to obtain component values that are more realistic from a practical standpoint.

Component selection in the UHF and VHF frequency ranges becomes a major problem, and the network configuration to obtain realistic component values is of vital importance to the design engineer. Design calculations for matching networks can become completely meaningless unless the components for the network are measured at the operating frequency.

For example, a 100 pF silver mica capacitor that meets all specifications at 1 MHz can have as much capacitance as 300 pF at 100 MHz. At some frequency, the capacitor's series lead inductance will finally tune out the capacitance, thus leaving the capacitor net inductive.

Values of inductance in the low nanohenry range are also difficult to obtain, since the inductance of a one-inch straight piece of #20 solid tinned wire is approximately 20 nH.

Component tolerances have no meaning at VHF frequencies and above unless they are specified at the operating frequency. It cannot be over-emphasized that components must be measured at the operating frequency.

NETWORK SOLUTIONS

The resistor and capacitor shown in the box labeled "device to be matched" represent the complex input or output impedance of a transistor. These complex impedances have been represented in series form in some cases and parallel form in others, depending on which form is most convenient for network calculation. The resultant impedance of the network, when terminated with $50 + j 0$ ohms, must be equal to the conjugate of the impedance in the box. The computer tabulations provide this solution.

Network A (see Figure 1) is applicable only when the "device to be matched" has a series real part of less than 50 ohms. As we can see from the computer tabulation, as the series real part approaches 50 ohms, the reactance of C_1 approaches infinity. However, in RF power amplifiers, we normally find that the series real part of both the input and the output is less than 50 ohms, making this matching network applicable to most RF power amplifier stages. Where the terminating impedance is other than 50 ohms, the mathematical procedure for the network solution is given in Appendix I.

Network B (see Figure 2) is the Pi network widely used in vacuum tube transmitters. As is apparent from the computer tabulation, this network is often impractical for use where R_1 is small. For values of R_1 less than 50 ohms, the inductance of L becomes impractically small while the capacitance of both C_1 and C_2 become very large. Where the Pi network configuration must be used to match low values of impedance, a double Pi network, in which the Q of the first section is very low, can be utilized to yield practical components.

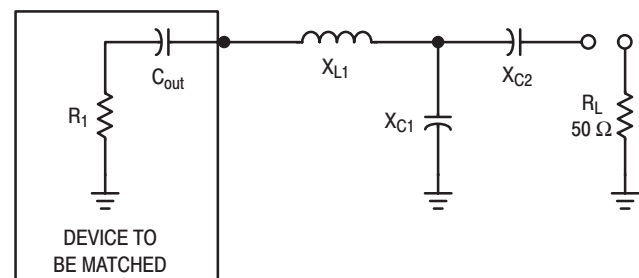

Figure 1. Network A

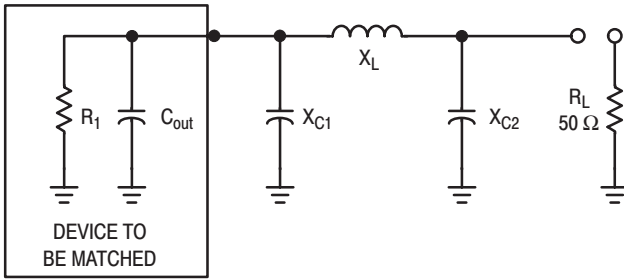

Figure 2. Network B

Network C has been solved in two forms (see Figure 3). Both of these networks have the limitation that R_1 must be less than 50 ohms. However, it must be stressed that this network configuration quite often yields the most practical components where low values of R_1 must be matched.

Network D (see Figure 4) is a "Tee" network. This network is useful for matching impedance less than or greater than 50 ohms. It has been observed in laboratory tests that this network configuration also yields very high collector efficiencies when used for output matching in transistor RF power amplifier stages.

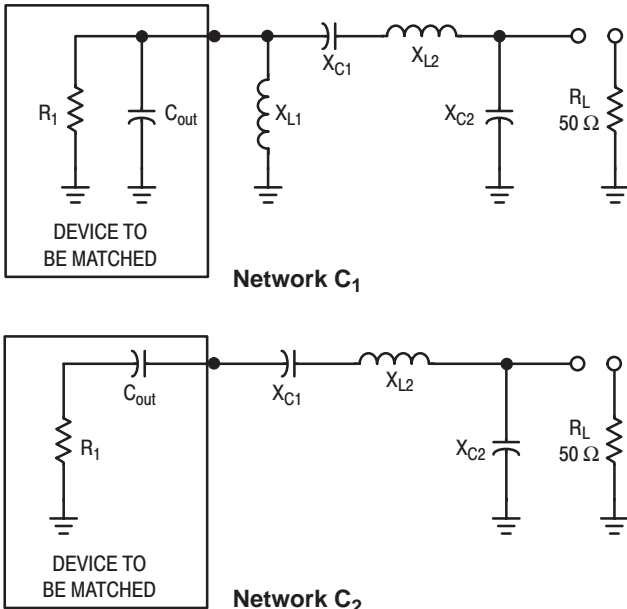

Figure 3.

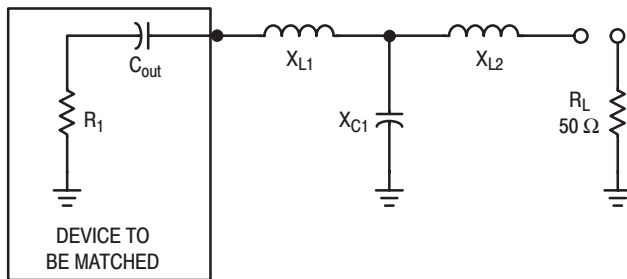

Figure 4. Network D

SUMMARY

Four computer-solved networks have been presented. The mathematical procedure for the solution of each network has been given in Appendix I.* Although the networks have found major use in matching solid-state RF power amplifier stages, they are also applicable to any circuit where the individual network's limitations are fulfilled.

*For the derivation of the equations used, refer to Electronic Circuit Analysis, Volume 1, "Passive Networks," Philip Cutler.

APPENDIX I

To convert a parallel resistance and reactance combination to series:

$$R_s = \frac{R_p}{1 + (R_p/X_p)^2}$$

$$X_s = R_s \frac{R_p}{X_p}$$

To convert a series resistance and reactance combination to parallel:

$$R_p = R_s [1 + (X_s/R_s)^2]$$

$$X_p = \frac{R_p}{X_s/R_s}$$

To solve network A:

1. Select a Q

$$X_{L1} = QR_1 + X_{Cout}$$

$$X_{C2} = AR_L$$

$$X_{C1} = \frac{(B/A)(B/Q)}{(B/A) - (B/Q)} = \frac{B}{Q - A}$$

$$\text{where } A = \sqrt{\left[\frac{R_1(1+Q^2)}{R_L} \right] - 1}$$

$$B = R_1(1+Q^2)$$

To solve network B:

1. Select a Q

$$X_{C1} = R_1/Q$$

$$X_{C2} = R_L \sqrt{\frac{R_1/R_L}{(Q^2 + 1) - (R_1/R_L)}}$$

$$X_L = \frac{QR_1 + (R_1R_L/X_{C2})}{Q^2 + 1}$$

To solve network C1:

1. Select a Q

$$X_{L1} = X_{Cout}$$

$$X_{C1} = QR_1$$

$$X_{C2} = R_L \sqrt{\frac{R_1}{R_L - R_1}}$$

$$X_{L2} = X_{C1} + \left(\frac{R_1R_L}{X_{C2}} \right)$$

To solve network C₂:

1. Select a Q
2. L₁ is not used in this network

$$X_{C1} = QR_1$$

$$X_{C2} = R_L \sqrt{\frac{R_1}{R_L - R_1}}$$

$$X_{L2} = X_{C1} + \left(\frac{R_1 R_L}{X_{C2}} \right) + X_{Cout}$$

To solve network D:

1. Select a Q

$$X_{L1} = (R_1 Q) + X_{Cout}$$

$$X_{L2} = R_L B$$

$$X_{C1} = \frac{(A/Q)(A/B)}{(A/Q) + (A/B)} = \frac{A}{Q + B}$$

where $A = R_1 (1 + Q^2)$

$$B = \sqrt{\left(\frac{A}{R_L} \right) - 1}$$

NETWORK A

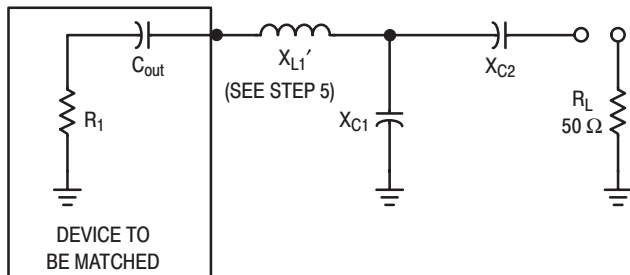

TO DESIGN A NETWORK USING THE TABLES

1. Transform the parallel impedance of the device to be matched to series form $(R_1 + jX_{Cout})$.
2. Define Q, in column one, as $X_{L1'}/R_1$.
3. Choose a Q.
4. For a Q, find the R_s to be matched in the R column and read the reactive value of the components.
5. $X_{L1'}$ is equal to the quantity X_{L1} obtained from the tables plus $|X_{Cout}|$.
6. This completes the network.

Q	X_{L1}	X_{C1}	X_{C2}	R_1
1	26	65	10	26
1	27	75.3	14.14	27
1	28	85.68	17.32	28
1	29	96.66	20	29
1	30	108.5	22.36	30
1	32	136	26.46	32
1	34	170	30	34
1	36	213.8	33.16	36
1	38	272.5	36.05	38
1	40	355	38.7	40
1	42	479	41.23	42
1	44	686.32	43.59	44
1	46	1102	45.83	46
1	48	2351	48	48
2	22	32.7	15.8	11
2	24	38.6	22.4	12
2	26	45	27.4	13
2	28	51.2	31.6	14
2	30	58	35.4	15
2	32	65.3	38.7	16
2	34	73.1	41.8	17
2	36	81.4	44.7	18
2	38	90.3	47.4	19
2	40	100	50	20
2	42	110.4	52.4	21
2	44	122	55	22
2	46	134	57	23
2	48	147	59	24
2	50	161	61	25
2	52	177	63	26
2	54	194	65	27
2	56	213	67	28
2	58	233	69	29
2	60	256	71	30
2	64	310	74	32
2	68	377	77	34
2	72	464	81	36
2	76	582	84	38
2	80	746	87	40
2	84	995	89	42
2	88	1409	92	44
2	92	2241	95	46
2	96	4739	97	48
3	18	23.5	22.3	6
3	21	29.6	31.6	7
3	24	35.9	38.7	8
3	27	42.7	44.7	9
3	30	50	50	10
3	33	57.8	54.8	11
3	36	66	59	12
3	39	75	63.2	13

Q	X_{L1}	X_{C1}	X_{C2}	R_1
3	42	84	67	14
3	45	95	71	15
3	48	105	74	16
3	51	117	77	17
3	54	130	81	18
3	57	143	84	19
3	60	158	87	20
3	63	173	89	21
3	66	190	92	22
3	69	209	95	23
3	72	228	97	24
3	75	250	100	25
3	78	274	102	26
3	81	299	105	27
3	84	327	107	28
3	87	358	110	29
3	90	393	112	30
3	96	473	116	32
3	102	575	120	34
3	108	706	124	36
3	114	882	128	38
3	120	1129	132	40
3	126	1502	136	42
3	132	2124	140	44
3	138	3372	143	46
3	144	7119	146	48
4	12	13.2	7.1	3
4	16	20	30	4
4	20	26.9	41.8	5
4	24	34.2	51	6
4	28	42.1	58.7	7
4	32	50.6	66	8
4	36	60	72	9
4	40	69	77	10
4	44	80	83	11
4	48	91	88	12
4	52	103	92	13
4	56	115	97	14
4	60	129	101	15
4	64	144	105	16
4	68	159	109	17
4	72	176	113	18
4	76	194	117	19
4	80	214	120	20
4	84	235	124	21
4	88	257	127	22
4	92	282	131	23
4	96	308	134	24
4	100	337	137	25
4	104	368	140	26
4	108	403	143	27

Q	X_{L1}	X_{C1}	X_{C2}	R_1
4	112	440	146	28
4	116	482	149	29
4	120	527	152	30
4	128	635	157	32
4	136	770	162	34
4	144	945	168	36
4	152	1180	173	38
4	160	1510	177	40
4	168	2007	182	42
4	176	2837	187	44
4	184	4500	191	46
4	192	9497	196	48
5	10	10.8	10	2
5	15	18.3	37.4	3
5	20	26.3	52	4
5	25	34.8	63.2	5
5	30	44	73	6
5	35	54	81	7
5	40	65	89	8
5	45	76	96	9
5	50	88	102	10
5	55	101	108	11
5	60	115	114	12
5	65	130	120	13
5	70	146	125	14
5	75	163	130	15
5	80	181	135	16
5	85	201	140	17
5	90	222	145	18
5	95	245	149	19
5	100	269	153	20
5	105	295	157	21
5	110	323	162	22
5	115	354	166	23
5	120	387	169	24
5	125	423	173	25
5	130	462	177	26
5	135	505	181	27
5	140	553	184	28
5	145	604	188	29
5	150	662	191	30
5	160	796	198	32
5	170	965	204	34
5	180	1184	210	36
5	190	1477	217	38
5	200	1890	222	40
5	210	2510	228	42
5	220	3548	234	44
5	230	5628	239	46
5	240	11874	245	48

Q	X _{L1}	X _{C1}	X _{C2}	R ₁
6	12	13.9	34.6	2
6	18	22.7	55.2	3
6	24	32.2	70	4
6	30	42.5	82	5
6	36	53.6	93	6
6	42	65.5	102	7
6	48	78	110	8
6	54	92	119	9
6	60	107	126	10
6	66	122	133	11
6	72	139	140	12
6	78	157	147	13
6	84	176	153	14
6	90	197	159	15
6	96	219	165	16
6	102	242	170	17
6	108	267	175	18
6	114	295	181	19
6	120	324	186	20
6	126	355	191	21
6	132	389	195	22
6	138	426	200	23
6	144	466	205	24
6	150	509	209	25
6	156	556	214	26
6	162	608	218	27
6	168	664	222	28
6	174	727	226	29
6	180	795	230	30
6	192	957	238	32
6	204	1160	246	34
6	216	1422	253	36
6	228	1775	260	38
6	240	2270	267	40
6	252	3015	274	42
6	264	4260	281	44
6	276	6755	287	46
6	288	14250	294	48
7	14	16.7	50	2
7	21	26.8	71	3
7	28	38	87	4
7	35	50	100	5
7	42	63	112	6
7	49	77	122	7
7	56	92	132	8
7	63	108	141	9
7	70	125	150	10
7	77	143	158	11
7	84	163	166	12
7	91	184	173	13
7	98	206	180	14
7	105	230	187	15
7	112	256	193	16
7	119	283	200	17
7	126	313	206	18
7	133	344	212	19
7	140	379	218	20
7	147	415	224	21
7	154	455	229	22
7	161	498	234	23
7	168	544	239	24
7	175	595	245	25
7	182	650	250	26

Q	X _{L1}	X _{C1}	X _{C2}	R ₁
7	189	710	255	27
7	196	776	260	28
7	203	849	265	29
7	210	929	269	30
7	224	1117	278	32
7	238	1354	287	34
7	252	1661	296	36
7	266	2071	304	38
7	280	2649	312	40
7	294	3518	320	42
7	308	4971	328	44
7	322	7882	335	46
7	336	16626	343	48
8	8	8.7	27.4	1
8	16	19.3	63.2	2
8	24	31	85	3
8	32	43.6	102	4
8	40	57.4	117	5
8	48	72	130	6
8	56	88	142	7
8	64	105	153	8
8	72	124	164	9
8	80	143	173	10
8	88	164	182	11
8	96	187	191	12
8	104	211	199	13
8	112	236	207	14
8	120	264	215	15
8	128	293	222	16
8	136	324	230	17
8	144	358	237	18
8	152	394	243	19
8	160	433	250	20
8	168	475	256	21
8	176	521	263	22
8	184	570	269	23
8	192	623	275	24
8	200	681	281	25
8	208	744	286	26
8	216	812	292	27
8	224	888	297	28
8	232	971	303	29
8	240	1062	308	30
8	256	1277	318	32
8	272	1548	329	34
8	288	1899	338	36
8	304	2368	348	38
8	320	3028	357	40
8	336	4022	366	42
8	352	5682	375	44
8	368	9009	383	46
9	9	10	40	1
9	18	21.9	76	2
9	27	35	99	3
9	36	49.4	118	4
9	45	65	134	5
9	54	82	149	6
9	63	100	162	7
9	72	119	174	8
9	81	139	185	9
9	90	162	196	10
9	99	185	206	11

Q	X _{L1}	X _{C1}	X _{C2}	R ₁
9	108	210	216	12
9	117	237	225	13
9	126	266	234	14
9	135	297	243	15
9	144	330	251	16
9	153	365	259	17
9	162	403	267	18
9	171	444	275	19
9	180	488	282	20
9	189	535	289	21
9	198	586	296	22
9	207	641	303	23
9	216	701	310	24
9	225	766	316	25
9	234	837	323	26
9	243	914	329	27
9	252	999	335	28
9	261	1092	341	29
9	270	1196	347	30
9	288	1438	359	32
9	306	1743	370	34
9	324	2137	381	36
9	342	2665	391	38
9	360	3407	402	40
9	378	4525	412	42
9	396	6393	422	44
10	10	11.2	50.5	1
10	20	24.5	87	2
10	30	39	112	3
10	40	55	133	4
10	50	72	151	5
10	60	91	167	6
10	70	111	181	7
10	80	132	195	8
10	90	155	207	9
10	100	180	219	10
10	110	206	230	11
10	120	234	241	12
10	130	264	251	13
10	140	296	261	14
10	150	330	271	15
10	160	367	280	16
10	170	406	289	17
10	180	448	297	18
10	190	494	306	19
10	200	543	314	20
10	210	595	322	21
10	220	652	330	22
10	230	713	337	23
10	240	780	345	24
10	250	852	352	25
10	260	930	359	26
10	270	1016	366	27
10	280	1111	373	28
10	290	1214	379	29
10	300	1329	383	30
10	320	1598	399	32
10	340	1937	411	34
10	360	2375	423	36
10	380	2961	435	38
10	400	3787	446	40
10	420	5029	458	42
10	440	7104	469	44

NETWORK B

The following is a computer solution for the Pi network when R_L equals 50 ohms.

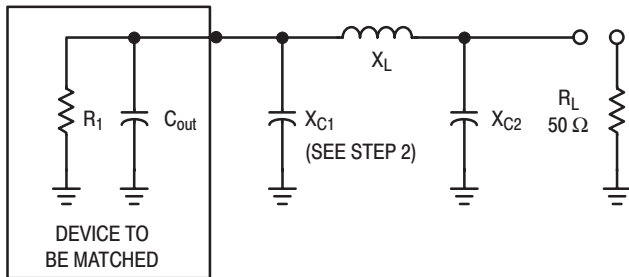

TO DESIGN A NETWORK USING THE TABLES

1. Define Q, in column one, as R_1/X_{C1} .
2. C_1 actual is equal to C_1 – parallel C_{out} of device to be matched.
3. This completes the network.

Q	X_{C1}	X_{C2}	X_L	R_1
1	1	5.03	5.47	1
1	2	7.14	8	2
1	3	8.79	10.03	3
1	4	10.21	11.8	4
1	5	11.47	13.4	5
1	10	16.67	20	10
1	15	21	25.35	15
1	20	25	30	20
1	25	28.87	34.15	25
1	30	32.73	37.91	30
1	35	36.69	41.35	35
1	40	40.82	44.49	40
1	45	45.23	47.37	45
1	50	50	50	50
1	55	55.28	52.37	55
1	60	61.24	54.49	60
1	65	68.14	56.35	65
1	70	76.38	57.91	70
1	75	86.6	59.15	75
1	80	100	60	80
1	85	119.02	60.35	85
1	90	150	60	90
2	0.5	3.17	3.56	1
2	1	4.49	5.25	2
2	1.5	5.51	6.64	3
2	2	6.38	7.87	4
2	2.5	7.14	9	5
2	5	10.21	13.8	10
2	7.5	12.63	17.87	15
2	10	14.74	21.56	20
2	12.5	16.67	25	25
2	15	18.46	28.25	30
2	17.5	20.17	31.35	35
2	20	21.82	34.33	40
2	22.5	23.43	37.21	45
2	25	25	40	50
2	27.5	26.55	42.71	55
2	30	28.1	45.35	60
2	32.5	29.64	47.93	65
2	35	31.18	50.45	70
2	37.5	32.73	52.91	75
2	40	34.3	55.32	80
2	42.5	35.89	57.69	85
2	45	37.5	60	90
2	47.5	39.14	62.27	95
2	50	40.82	64.49	100
2	62.5	50	75	125
2	75	61.24	84.49	150
2	87.5	76.38	92.91	175
2	100	100	100	200
2	112.5	150	105	225

Q	X_{C1}	X_{C2}	X_L	R_1
3	0.33	2.24	2.53	1
3	0.67	3.17	3.76	2
3	1	3.88	4.76	3
3	1.33	4.49	5.65	4
3	1.67	5.03	6.47	5
3	3.33	7.14	10	10
3	5	8.79	13.03	15
3	6.67	10.21	15.8	20
3	8.33	11.47	18.4	25
3	10	12.63	20.87	30
3	11.67	13.72	23.26	35
3	13.33	14.74	25.56	40
3	15	15.72	27.81	45
3	16.67	16.67	30	50
3	18.33	17.58	32.14	55
3	20	18.46	34.25	60
3	21.67	19.33	36.32	65
3	23.33	20.17	38.35	70
3	25	21	40.35	75
3	26.67	21.82	42.33	80
3	28.33	22.63	44.28	85
3	30	23.43	46.21	90
3	31.67	24.22	48.12	95
3	33.33	25	50	100
3	41.67	28.87	59.12	125
3	50	32.73	67.91	150
3	58.33	36.69	76.35	175
3	66.67	40.82	84.49	200
3	75	45.23	92.37	225
3	83.33	50	100	250
4	6.25	8.7	14.33	25
4	12.5	12.5	23.53	50
4	18.75	15.55	31.83	75
4	25	18.26	39.64	100
4	31.25	20.76	47.12	125
4	37.5	23.15	54.36	150
4	43.75	25.46	61.39	175
4	50	27.74	68.27	200
4	56.25	30	75	225
4	62.5	32.27	81.61	250
4	75	36.93	94.48	300
4	100	47.14	119.07	400
4	125	59.76	142.25	500
4	150	77.46	163.96	600
4	175	108.01	183.77	700
4	200	200	200	800
5	0.2	1.39	1.58	1
5	5	7	11.67	25
5	10	10	19.23	50
5	15	12.37	26.08	75

Q	X_{C1}	X_{C2}	X_L	R_1
5	20	14.43	32.55	100
5	25	16.31	38.78	125
5	30	18.06	44.82	150
5	35	19.72	50.72	175
5	40	21.32	56.5	200
5	45	22.87	62.18	225
5	50	24.4	67.78	250
5	60	27.39	78.76	300
5	80	33.33	100	400
5	100	39.53	120.48	500
5	120	46.29	140.31	600
5	140	54.01	159.54	700
5	160	63.25	178.17	800
5	180	75	196.15	900
5	200	91.29	213.37	1000
5	220	117.26	229.58	1100
5	240	173.21	244.09	1200
6	0.17	1.16	1.32	1
6	4.17	5.85	9.83	25
6	8.33	8.33	16.22	50
6	12.5	10.28	22.02	75
6	16.67	11.95	27.52	100
6	20.83	13.46	32.82	125
6	25	14.85	37.97	150
6	29.17	16.16	43.01	175
6	33.33	17.41	47.96	200
6	37.5	18.61	52.83	225
6	41.67	19.76	57.63	250
6	50	22	67.08	300
6	66.67	26.26	85.45	400
6	83.33	30.43	103.29	500
6	100	34.64	120.7	600
6	116.67	39.01	137.76	700
6	133.33	43.64	154.5	800
6	150	48.67	170.94	900
6	166.67	54.23	187.08	1000
6	183.33	60.55	202.93	1100
6	200	67.94	218.46	1200
6	216.67	76.87	233.66	1300
6	233.33	88.19	248.48	1400
6	250	103.51	262.83	1500
6	266.67	126.49	276.55	1600
6	283.33	168.33	289.32	1700
6	300	300	300	1800
7	0.14	1	1.14	1
7	3.57	5.03	8.47	25
7	7.14	7.14	14	50
7	10.71	8.79	19.03	75
7	14.29	10.21	23.8	100
7	17.86	11.47	28.4	125

Q	X _{C1}	X _{C2}	X _L	R ₁	Q	X _{C1}	X _{C2}	X _L	R ₁	Q	X _{C1}	X _{C2}	X _L	R ₁
7	21.43	12.63	32.87	150	10	0.1	0.7	0.8	1	16	18.75	7.73	26.23	300
7	25	13.72	37.26	175	10	5	5	9.9	50	16	25	8.96	33.59	400
7	28.57	14.74	41.56	200	10	10	7.11	16.87	100	16	31.25	10.06	40.8	500
7	32.14	15.72	45.81	225	10	15	8.75	23.34	150	16	37.5	11.07	47.9	600
7	35.71	16.67	50	250	10	20	10.15	29.55	200	16	43.75	12	54.93	700
7	42.86	18.46	58.25	300	10	25	11.41	35.6	250	16	50	12.88	61.89	800
7	57.14	21.82	74.33	400	10	30	12.57	41.52	300	16	56.25	13.72	68.79	900
7	71.43	25	90	500	10	40	14.66	53.11	400	16	62.5	14.52	75.65	1000
7	85.71	28.1	105.35	600	10	50	16.57	64.44	500	16	75	16.05	89.26	1200
7	100	31.18	120.45	700	10	60	18.36	75.58	600	16	87.5	17.48	102.74	1400
7	114.29	34.3	135.32	800	10	70	20.06	86.58	700	16	100	18.86	116.12	1600
7	128.57	37.5	150	900	10	80	21.69	97.46	800	16	112.5	20.18	129.42	1800
7	142.86	40.82	164.49	1000	10	90	23.28	108.24	900	16	125	21.47	142.64	2000
7	171.43	48.04	192.98	1200	10	100	24.85	118.94	1000	16	137.5	22.73	155.8	2200
7	200	56.41	220.82	1400	10	120	27.91	140.09	1200	16	150	23.96	168.9	2400
7	228.57	66.67	248	1600	10	140	30.97	161	1400	16	162.5	25.18	181.95	2600
7	257.14	80.18	274.45	1800	10	160	34.05	181.68	1600	16	175	26.39	194.96	2800
7	285.71	100	300	2000	10	180	37.21	202.17	1800	16	187.5	27.59	207.92	3000
7	314.29	135.4	324.25	2200	10	200	40.49	222.47	2000	16	218.75	30.59	240.16	3500
7	342.86	244.95	345.8	2400	10	220	43.93	242.61	2200	16	250	33.61	272.18	4000
8	0.13	0.88	1	1	10	240	47.58	262.59	2400	16	281.25	36.71	304.01	4500
8	3.13	4.4	7.45	25	12	25	10.39	34.79	300	16	312.5	39.9	335.66	5000
8	6.25	6.25	12.31	50	12	33.33	12.08	44.52	400	16	343.75	43.25	367.15	5500
8	9.38	7.68	16.74	75	12	41.67	13.61	54.05	500	16	375	46.8	398.49	6000
8	12.5	8.91	20.94	100	12	50	15.02	63.43	600	18	16.67	6.86	23.35	300
8	15.63	10	25	125	12	58.33	16.35	72.7	700	18	22.22	7.94	29.9	400
8	18.75	11	28.95	150	12	66.67	17.61	81.87	800	18	27.78	8.91	36.33	500
8	21.88	11.93	32.82	175	12	75	18.82	90.97	900	18	33.33	9.79	42.66	600
8	25	12.8	36.63	200	12	83.33	20	100	1000	18	38.89	10.61	48.92	700
8	28.13	13.64	40.38	225	12	100	22.27	117.89	1200	18	44.44	11.38	55.13	800
8	31.25	14.43	44.09	250	12	116.67	24.46	135.6	1400	18	50	12.11	61.28	900
8	37.5	15.94	51.4	300	12	133.33	26.61	153.15	1600	18	55.56	12.8	67.4	1000
8	50	18.73	65.66	400	12	150	28.73	170.57	1800	18	66.67	14.12	79.54	1200
8	62.5	21.32	79.58	500	12	166.67	30.86	187.86	2000	18	77.78	15.35	91.57	1400
8	75	23.79	93.25	600	12	183.33	33	205.06	2200	18	88.89	16.52	103.51	1600
8	87.5	26.2	106.71	700	12	200	35.17	222.15	2400	18	100	17.65	115.38	1800
8	100	28.57	120	800	12	216.67	37.39	239.16	2600	18	111.11	18.73	127.2	2000
8	112.5	30.94	133.14	900	12	233.33	39.66	256.07	2800	18	122.22	19.79	138.95	2200
8	125	33.33	146.15	1000	12	250	42.01	272.9	3000	18	133.33	20.81	150.66	2400
8	150	38.25	171.82	1200	12	291.67	48.3	314.64	3500	18	144.44	21.82	162.33	2600
8	175	43.5	197.07	1400	12	333.33	55.47	355.9	4000	18	155.56	22.81	173.96	2800
8	200	49.24	221.92	1600	12	375	63.96	396.67	4500	18	166.67	23.79	185.55	3000
8	225	55.71	246.39	1800	12	416.67	74.54	436.92	5000	18	194.44	26.2	214.4	3500
8	250	63.25	270.48	2000	12	458.33	88.64	476.57	5500	18	222.22	28.57	243.08	4000
8	275	72.37	294.15	2200	12	500	109.54	515.44	6000	18	250	30.94	271.6	4500
8	300	84.02	317.36	2400	12	500	109.54	515.44	6000	18	277.78	33.33	300	5000
9	8.33	6.83	14.93	75	14	21.43	8.86	29.91	300	18	305.56	35.76	328.27	5500
9	11.11	7.91	18.69	100	14	28.57	10.29	38.3	400	18	333.33	38.25	356.44	6000
9	13.89	8.87	22.32	125	14	35.71	11.56	46.51	500	20	15	6.16	21.03	300
9	16.67	9.74	25.85	150	14	42.86	12.73	54.6	600	20	20	7.13	26.94	400
9	19.44	10.56	29.31	175	14	50	13.83	62.59	700	20	25	8	32.73	500
9	22.22	11.32	32.72	200	14	57.14	14.87	70.51	800	20	30	8.78	38.44	600
9	25	12.05	36.08	225	14	64.29	15.86	78.37	900	20	35	9.51	44.09	700
9	27.78	12.74	39.4	250	14	71.43	16.81	86.17	1000	20	40	10.19	49.69	800
9	33.33	14.05	45.95	300	14	85.71	18.62	101.63	1200	20	45	10.84	55.24	900
9	44.44	16.44	58.74	400	14	100	20.35	116.95	1400	20	50	11.46	60.76	1000
9	55.56	18.63	71.24	500	14	114.29	22.02	132.15	1600	20	60	12.62	71.71	1200
9	66.67	20.7	83.53	600	14	128.57	23.64	147.24	1800	20	70	13.7	82.57	1400
9	77.78	22.69	95.64	700	14	142.86	25.24	162.25	2000	20	80	14.72	93.35	1600
9	88.89	24.62	107.62	800	14	157.14	26.81	177.17	2200	20	90	15.7	104.07	1800
9	100	26.52	119.48	900	14	171.43	28.38	192.02	2400	20	100	16.64	114.73	2000
9	111.11	28.4	131.23	1000	14	185.71	29.94	206.81	2600	20	110	17.55	125.35	2200
9	133.33	32.16	154.46	1200	14	200	31.51	221.54	2800	20	120	18.44	135.93	2400
9	155.56	36	177.37	1400	14	214.29	33.09	236.21	3000	20	130	19.3	146.47	2600
9	177.78	40	200	1600	14	250	37.12	272.66	3500	20	140	20.14	156.98	2800
9	200	44.23	222.37	1800	14	285.71	41.34	308.82	4000	20	150	20.97	167.46	3000
9	222.22	48.8	244.5	2000	14	321.43	45.86	344.7	4500	20	175	22.99	193.54	3500
9	244.44	53.8	266.4	2200	14	357.14	50.77	380.33	5000	20	200	24.96	219.48	4000
9	266.67	59.41	288.05	2400	14	392.86	56.22	415.69	5500	20	225	26.9	245.3	4500
					14	428.57	62.42	450.79	6000	20	250	28.82	271.01	5000
										20	275	30.74	296.62	5500
										20	300	32.67	322.15	6000

NETWORK C₁

The following is a computer solution for an RF matching network.
This computer solution is applicable for two forms of matching networks.

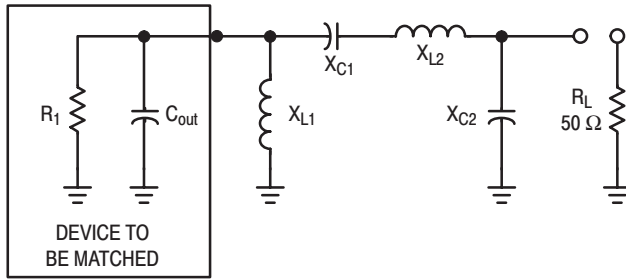

TO DESIGN A NETWORK USING THE TABLES

1. $X_{L1} = X_{Cout}$.
2. Define Q, in column one, as X_{C1}/R_1 .
3. All network values can now be read from the charts in terms of reactance.
4. This completes network C₁.

NETWORK C₂

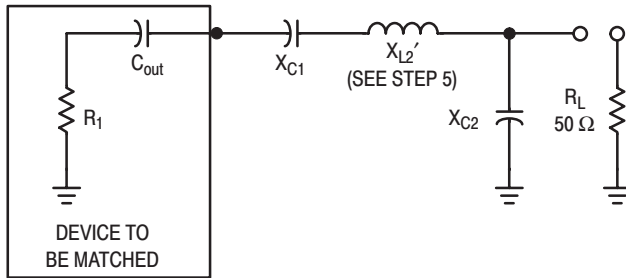

TO DESIGN A NETWORK USING THE TABLES

1. L₁ is not used in this network.
2. Transform the impedance of the device to be matched to series form ($R_1 + jX_{Cout}$).
3. Define Q, in column one, as X_{C1}/R_1 .
4. For a desired Q, find the R_s to be matched in the R₁ column and read the reactive value of the components
5. $X_{L2'}$ is equal to the quantity X_{L2} obtained from the tables plus $|X_{Cout}|$.
6. This completes network C₂.

Q	X _{C1}	X _{C2}	X _{L2}	R ₁
1	1	7.14	8	1
1	2	10.21	11.8	2
1	3	12.63	14.87	3
1	4	14.74	17.56	4
1	5	16.67	20	5
1	6	18.46	22.25	6
1	7	20.17	24.35	7
1	8	21.82	26.33	8
1	9	23.43	28.21	9
1	10	25	30	10
1	11	26.55	31.81	11
1	12	28.1	33.35	12
1	13	29.64	34.93	13
1	14	31.13	36.45	14
1	15	32.73	37.91	15
1	16	34.3	39.32	16
1	17	35.89	40.69	17
1	18	37.5	42	18
1	19	39.14	43.27	19
1	20	40.82	44.49	20
1	21	42.55	45.68	21
1	22	44.32	46.82	22
1	23	46.15	47.92	23
1	24	48.04	48.98	24
1	25	50	50	25
1	26	52.04	50.98	26
1	27	54.17	51.92	27
1	28	56.41	52.82	28
1	29	58.76	53.68	29
1	30	61.24	54.49	30
1	32	66.67	56	32
1	34	72.89	57.32	34
1	36	80.18	58.45	36

Q	X _{C1}	X _{C2}	X _{L2}	R ₁
1	38	88.98	59.35	38
1	40	100	60	40
1	42	114.56	60.33	42
1	44	135.4	60.25	44
1	46	169.56	59.56	46
1	48	244.95	57.8	48
2	2	7.14	9	1
2	4	10.21	13.8	2
2	6	12.63	17.87	3
2	8	14.74	21.56	4
2	10	16.67	25	5
2	12	18.46	28.25	6
2	14	20.17	31.35	7
2	16	21.82	34.33	8
2	18	23.43	37.21	9
2	20	25	40	10
2	22	26.55	42.71	11
2	24	28.1	45.35	12
2	26	29.64	47.93	13
2	28	31.18	50.45	14
2	30	32.73	52.91	15
2	32	34.3	55.32	16
2	34	35.89	57.69	17
2	36	37.5	60	18
2	38	39.14	62.27	19
2	40	40.82	64.49	20
2	42	42.55	66.68	21
2	44	44.32	68.82	22
2	46	46.15	70.92	23
2	48	48.04	72.98	24
2	50	50	75	25
2	52	52.04	76.98	26

Q	X _{C1}	X _{C2}	X _{L2}	R ₁
2	54	54.17	78.92	27
2	56	56.41	80.82	28
2	58	58.76	82.68	29
2	60	61.24	84.49	30
2	64	66.67	88	32
2	68	72.89	91.32	34
2	72	80.18	94.45	36
2	76	88.98	97.35	38
2	80	100	100	40
2	84	114.56	102.33	42
2	88	135.4	104.25	44
2	92	169.56	105.56	46
2	96	244.95	105.8	48
3	3	7.14	10	1
3	6	10.21	15.8	2
3	9	12.63	20.87	3
3	12	14.74	25.56	4
3	15	16.67	30	5
3	18	18.46	34.25	6
3	21	20.17	38.35	7
3	24	21.82	42.33	8
3	27	23.43	46.21	9
3	30	25	50	10
3	33	26.55	53.71	11
3	36	28.1	57.35	12
3	39	29.64	60.98	13
3	42	31.18	64.45	14
3	45	32.73	67.91	15
3	48	34.3	71.32	16
3	51	35.89	74.69	17
3	54	37.5	78	18
3	57	39.14	81.27	19

Q	X _{C1}	X _{C2}	X _{L2}	R ₁
3	60	40.82	84.49	20
3	63	42.55	87.68	21
3	66	44.32	90.82	22
3	69	46.15	93.93	23
3	72	48.04	96.98	24
3	75	50	100	25
3	78	52.04	102.98	26
3	81	54.17	105.92	27
3	84	56.41	108.82	28
3	87	58.76	111.68	29
3	90	61.24	114.49	30
3	96	66.67	120	32
3	102	72.89	125.32	34
3	108	80.18	130.45	36
3	114	88.98	135.35	38
3	120	100	140	40
3	126	114.56	144.33	42
3	132	135.4	148.25	44
3	138	169.56	151.56	46
3	144	244.95	153.8	48
4	4	7.14	11	1
4	8	10.21	17.8	2
4	12	12.63	23.87	3
4	16	14.74	29.56	4
4	20	16.67	35	5
4	24	18.46	40.25	6
4	28	20.17	45.35	7
4	32	21.82	50.33	8
4	36	23.43	55.21	9
4	40	25	60	10
4	44	26.55	64.71	11
4	48	28.1	69.35	12
4	52	29.64	73.93	13
4	56	31.18	78.45	14
4	60	32.73	82.91	15
4	64	34.3	87.32	16
4	68	35.89	91.69	17
4	72	37.5	96	18
4	76	39.14	100.27	19
4	80	40.82	104.49	20
4	84	42.55	108.68	21
4	88	44.32	112.82	22
4	92	46.15	116.92	23
4	96	48.04	120.98	24
4	100	50	125	25
4	104	52.04	128.98	26
4	108	54.17	132.92	27
4	112	56.41	136.82	28
4	116	58.76	140.68	29
4	120	61.24	144.49	30
4	128	66.67	152	32
4	136	72.89	159.32	34
4	144	80.18	166.45	36
4	152	88.98	173.35	38
4	160	100	180	40
4	168	114.56	186.33	42
4	176	135.4	192.25	44
4	184	169.56	197.56	46
4	192	244.95	201.8	48
5	5	7.14	12	1
5	10	10.21	19.8	2
5	15	12.63	26.87	3
5	20	14.74	33.56	4
5	25	16.67	40	5
5	30	18.46	46.25	6
5	35	20.17	52.35	7

Q	X _{C1}	X _{C2}	X _{L2}	R ₁
5	40	21.82	58.33	8
5	45	23.43	64.21	9
5	50	25	70	10
5	55	26.55	75.71	11
5	60	28.1	81.35	12
5	65	29.64	86.93	13
5	70	31.18	92.45	14
5	75	32.73	97.91	15
5	80	34.3	103.32	16
5	85	35.89	108.69	17
5	90	37.5	114	18
5	95	39.14	119.27	19
5	100	40.82	124.49	20
5	105	42.55	129.68	21
5	110	44.32	134.82	22
5	115	46.15	139.92	23
5	120	48.04	144.98	24
5	125	50	150	25
5	130	52.04	154.98	26
5	135	54.17	159.92	27
5	140	56.41	164.82	28
5	145	58.76	169.68	29
5	150	61.24	174.49	30
5	160	66.67	184	32
5	170	72.89	193.32	34
5	180	80.18	202.45	36
5	190	88.98	211.35	38
5	200	100	220	40
5	210	114.56	228.33	42
5	220	135.4	236.25	44
5	230	169.56	243.56	46
5	240	244.95	249.8	48
6	6	7.14	13	1
6	12	10.21	21.8	2
6	18	12.63	29.87	3
6	24	14.74	37.56	4
6	30	16.67	45	5
6	36	18.46	52.25	6
6	42	20.17	59.35	7
6	48	21.82	66.33	8
6	54	23.43	73.21	9
6	60	25	80	10
6	66	26.55	86.71	11
6	72	28.1	93.35	12
6	78	29.64	99.93	13
6	84	31.18	106.45	14
6	90	32.73	112.91	15
6	96	34.3	119.32	16
6	102	35.89	125.69	17
6	108	37.5	132	18
6	114	39.14	138.27	19
6	120	40.82	144.49	20
6	126	42.55	150.68	21
6	132	44.32	156.82	22
6	138	46.15	162.92	23
6	144	48.04	168.98	24
6	150	50	175	25
6	156	52.04	180.98	26
6	162	54.17	186.92	27
6	168	56.41	192.82	28
6	174	58.76	198.68	29
6	180	61.24	204.49	30
6	192	66.67	216	32
6	204	72.89	227.32	34
6	216	80.18	238.45	36
6	228	88.98	249.35	38
6	240	100	260	40

Q	X _{C1}	X _{C2}	X _{L2}	R ₁
6	252	114.56	270.33	42
6	264	135.4	280.25	44
6	276	169.56	289.56	46
6	288	244.95	297.8	48
7	7	7.14	14	1
7	14	10.21	23.8	2
7	21	12.63	32.87	3
7	28	14.74	41.56	4
7	35	16.67	50	5
7	42	18.46	58.25	6
7	49	20.17	66.35	7
7	56	21.82	74.33	8
7	63	23.43	82.21	9
7	70	25	90	10
7	77	26.55	97.71	11
7	84	28.1	105.35	12
7	91	29.64	112.93	13
7	98	31.18	120.45	14
7	105	32.73	127.91	15
7	112	34.3	135.32	16
7	119	35.89	142.69	17
7	126	37.5	150	18
7	133	39.14	157.27	19
7	140	40.82	164.49	20
7	147	42.55	171.68	21
7	154	44.32	178.82	22
7	161	46.15	185.92	23
7	168	48.04	192.98	24
7	175	50	200	25
7	182	52.04	206.98	26
7	189	54.17	213.92	27
7	196	56.41	220.82	28
7	203	58.76	227.68	29
7	210	61.24	234.49	30
7	224	66.67	248	32
7	238	72.89	261.32	34
7	252	80.18	274.45	36
7	266	88.98	287.35	38
7	280	100	300	40
7	294	114.56	312.33	42
7	308	135.4	324.25	44
7	322	169.56	335.56	46
7	336	244.95	345.8	48
8	8	7.14	15	1
8	16	10.21	25.8	2
8	24	12.63	35.87	3
8	32	14.74	45.56	4
8	40	16.67	55	5
8	48	18.46	64.25	6
8	56	20.17	73.35	7
8	64	21.82	82.33	8
8	72	23.43	91.21	9
8	80	25	100	10
8	88	26.55	108.71	11
8	96	28.1	117.35	12
8	104	29.64	125.93	13
8	112	31.18	134.45	14
8	120	32.73	142.91	15
8	128	34.3	151.32	16
8	136	35.89	159.69	17
8	144	37.5	168	18
8	152	39.14	176.27	19
8	160	40.82	184.49	20
8	168	42.55	192.68	21
8	176	44.32	200.82	22
8	184	46.15	208.92	23

Q	X _{C1}	X _{C2}	X _{L2}	R ₁
8	192	48.04	216.98	24
8	200	50	225	25
8	208	52.04	232.98	26
8	216	54.17	240.92	27
8	224	56.41	248.82	28
8	232	58.76	256.68	29
8	240	61.24	264.49	30
8	256	66.67	280	32
8	272	72.89	295.32	34
8	288	80.18	310.45	36
8	304	88.98	325.35	38
8	320	100	340	40
8	336	114.56	354.33	42
8	352	135.4	368.25	44
8	368	169.56	381.56	46
8	384	244.95	393.8	48
9	9	7.14	16	1
9	18	10.21	27.8	2
9	27	12.63	38.87	3
9	36	14.74	49.56	4
9	45	16.67	60	5
9	54	18.46	70.25	6
9	63	20.17	80.35	7
9	72	21.82	90.33	8
9	81	23.43	100.21	9
9	90	25	110	10
9	99	26.55	119.71	11
9	108	28.1	129.35	12
9	117	29.64	138.93	13
9	126	31.18	148.45	14
9	135	32.73	157.91	15
9	144	34.3	167.32	16

Q	X _{C1}	X _{C2}	X _{L2}	R ₁
9	153	35.89	176.69	17
9	162	37.5	186	18
9	171	39.17	195.27	19
9	180	40.82	204.49	20
9	189	42.55	213.68	21
9	198	44.32	222.82	22
9	207	46.15	231.92	23
9	414	169.56	427.56	46
9	432	244.95	441.8	48
9	216	48.04	240.98	24
9	225	50	250	25
9	234	52.04	258.98	26
9	243	54.17	267.92	27
9	252	56.41	276.82	28
9	261	58.76	285.88	29
9	270	61.24	294.49	30
9	288	66.67	312	32
9	306	72.89	329.32	34
9	324	80.18	346.45	36
9	342	88.98	363.35	38
9	360	100	380	40
9	378	114.56	396.33	42
9	396	135.4	412.25	44
10	10	7.14	17	1
10	20	10.21	29.8	2
10	30	12.63	41.87	3
10	40	14.74	53.56	4
10	50	16.67	65	5
10	60	18.46	76.25	6
10	70	20.17	87.35	7
10	80	21.82	98.33	8

Q	X _{C1}	X _{C2}	X _{L2}	R ₁
10	90	23.43	109.21	9
10	100	25	120	10
10	110	26.55	130.71	11
10	120	28.1	141.35	12
10	130	29.64	151.93	13
10	140	31.18	162.45	14
10	150	32.73	172.91	15
10	160	34.3	183.32	16
10	170	35.89	193.69	17
10	180	37.5	204	18
10	190	39.14	214.27	19
10	200	40.82	224.49	20
10	210	42.55	234.68	21
10	220	44.32	244.82	22
10	230	46.15	254.92	23
10	240	48.04	264.98	24
10	250	50	275	25
10	260	52.04	284.98	26
10	270	54.17	294.92	27
10	280	56.41	304.82	28
10	290	58.76	314.68	29
10	300	61.24	324.49	30
10	320	66.67	344	32
10	340	72.89	363.32	34
10	360	80.18	382.45	36
10	380	88.98	401.35	38
10	400	100	420	40
10	420	114.56	438.33	42
10	440	135.4	456.25	44
10	460	169.56	473.56	46
10	480	244.95	489.8	48

NETWORK D

The following is a computer solution for an RF "Tee" matching network.

Tuning is accomplished by using a variable capacitor for C_1 .

Variable matching may also be accomplished by increasing X_{L2} and adding an equal amount of X_C in series in the form of a variable capacitor.

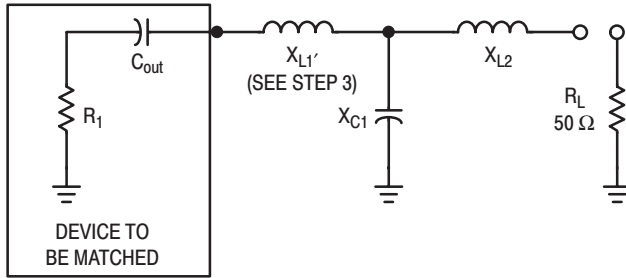

TO DESIGN A NETWORK USING THE TABLES

1. Define Q, in column one, as X_{L1}/R_1 .
2. For an R_1 to be matched and a desired Q, read the reactances of the network components from the charts.
3. X_{L1}' is equal to the quantity X_{L1} obtained from the tables plus $|X_{Cout}|$.
4. This completes the network.

Q	X_{L1}	X_{L2}	X_{C1}	R_1
1	26	10	43.33	26
1	27	14.14	42.09	27
1	28	17.32	41.59	28
1	29	20	41.43	29
1	30	22.36	41.46	30
1	32	26.46	41.85	32
1	34	30	42.5	34
1	36	33.17	43.29	36
1	38	36.06	44.16	38
1	40	38.73	45.08	40
1	42	41.23	46.04	42
1	44	43.59	47.01	44
1	46	45.83	48	46
1	48	47.96	49	48
1	50	50	50	50
1	55	54.77	52.49	55
1	60	59.16	54.96	60
1	65	63.25	57.4	65
1	70	67.08	59.79	70
1	75	70.71	62.13	75
1	80	74.16	64.43	80
1	85	77.46	66.69	85
1	90	80.62	68.9	90
1	95	83.67	71.07	95
1	100	86.6	73.21	100
1	125	100	83.33	125
1	150	111.8	92.71	150
1	175	122.47	101.46	175
1	200	132.29	109.72	200
1	225	141.42	117.54	225
1	250	150	125	250
1	275	158.11	132.14	275
1	300	165.83	139	300
2	22	15.81	23.75	11
2	24	22.36	24.52	12
2	26	27.39	25.51	13
2	28	31.62	26.59	14
2	30	35.36	27.7	15
2	32	38.73	28.83	16
2	34	41.83	29.96	17
2	36	44.72	31.09	18
2	38	47.43	32.22	19
2	40	50	33.33	20
2	42	52.44	34.44	21
2	44	54.77	35.54	22
2	46	57.01	36.62	23
2	48	59.16	37.7	24

Q	X_{L1}	X_{L2}	X_{C1}	R_1
2	50	61.24	38.76	25
2	52	63.25	39.82	26
2	54	65.19	40.86	27
2	56	67.08	41.9	28
2	58	68.92	42.92	29
2	60	70.71	43.93	30
2	64	74.16	45.93	32
2	68	77.46	47.9	34
2	72	80.62	49.83	36
2	76	83.67	51.72	38
2	80	86.6	53.59	40
2	84	89.44	55.43	42
2	88	92.2	57.23	44
2	92	94.87	59.01	46
2	96	97.47	60.77	48
2	100	100	62.5	50
2	110	106.07	66.73	55
2	120	111.8	70.82	60
2	130	117.26	74.8	65
2	140	122.47	78.66	70
2	150	127.48	82.43	75
2	160	132.29	86.1	80
2	170	136.93	89.69	85
2	180	141.42	93.2	90
2	190	145.77	96.63	95
2	200	150	100	100
2	250	169.56	115.93	125
2	300	187.08	130.62	150
2	350	203.1	144.34	175
2	400	217.94	157.26	200
2	450	231.84	169.51	225
2	500	244.95	181.19	250
2	550	257.39	192.37	275
2	600	269.26	203.11	300
3	18	22.36	17.41	6
3	21	31.62	19.27	7
3	24	38.73	21.19	8
3	27	44.72	23.11	9
3	30	50	25	10
3	33	54.77	26.86	11
3	36	59.16	28.69	12
3	39	63.25	30.48	13
3	42	67.08	32.25	14
3	45	70.71	33.98	15
3	48	74.16	35.69	16
3	51	77.46	37.37	17
3	54	80.62	39.02	18

Q	X_{L1}	X_{L2}	X_{C1}	R_1
3	57	83.67	40.66	19
3	60	86.6	42.26	20
3	63	89.44	43.85	21
3	66	92.2	45.42	22
3	69	94.87	46.96	23
3	72	97.47	48.49	24
3	75	100	50	25
3	78	102.47	51.49	26
3	81	104.88	52.97	27
3	84	107.24	54.42	28
3	87	109.54	55.87	29
3	90	111.8	57.29	30
3	96	116.19	60.11	32
3	102	120.42	62.87	34
3	108	124.5	65.57	36
3	114	128.45	68.23	38
3	120	132.29	70.85	40
3	126	136.01	73.42	42
3	132	139.64	75.96	44
3	138	143.18	78.45	46
3	144	146.63	80.91	48
3	150	150	83.33	50
3	165	158.11	89.25	55
3	180	165.83	94.99	60
3	195	173.21	100.56	65
3	210	180.28	105.97	70
3	225	187.08	111.25	75
3	240	193.65	116.4	80
3	255	200	121.43	85
3	270	206.16	126.35	90
3	285	212.13	131.17	95
3	300	217.94	135.89	100
3	375	244.95	158.25	125
3	450	269.26	178.89	150
3	525	291.55	198.17	175
3	600	312.25	216.33	200
3	675	331.66	233.57	225
3	750	350	250	250
3	825	367.42	265.74	275
3	900	384.06	280.87	300
4	12	7.07	12.31	3
4	16	30	14.78	4
4	20	41.83	17.57	5
4	24	50.99	20.32	6
4	28	58.74	23	7
4	32	65.57	25.6	8
4	36	71.76	28.15	9

Q	X _{L1}	X _{L2}	X _{C1}	R ₁
4	40	77.46	30.64	10
4	44	82.76	33.07	11
4	48	87.75	35.45	12
4	52	92.47	37.78	13
4	56	96.95	40.07	14
4	60	101.24	42.32	15
4	64	105.36	44.54	16
4	68	109.32	46.72	17
4	72	113.14	48.86	18
4	76	116.83	50.97	19
4	80	120.42	53.06	20
4	84	123.9	55.11	21
4	88	127.28	57.14	22
4	92	130.58	59.14	23
4	96	133.79	61.12	24
4	100	136.93	63.07	25
4	104	140	65	26
4	108	143	66.91	27
4	112	145.95	68.8	28
4	116	148.83	70.67	29
4	120	151.66	72.51	30
4	128	157.16	76.16	32
4	136	162.48	79.73	34
4	144	167.63	83.24	36
4	152	172.63	86.68	38
4	160	177.48	90.07	40
4	168	182.21	93.4	42
4	176	186.82	96.69	44
4	184	191.31	99.92	46
4	192	195.7	103.11	48
4	200	200	106.25	50
4	220	210.36	113.93	55
4	240	220.23	121.36	60
4	260	229.67	128.59	65
4	280	238.75	135.61	70
4	300	247.49	142.46	75
4	320	255.93	148.15	80
4	340	264.1	155.68	85
4	360	272.03	162.07	90
4	380	279.73	168.32	95
4	400	287.23	174.46	100
4	500	322.1	203.5	125
4	600	353.55	230.33	150
4	700	382.43	255.4	175
4	800	409.27	279.02	200
4	900	434.45	301.44	225
4	1000	458.26	322.82	250
4	1100	480.88	343.3	275
4	1200	502.49	362.99	300
5	10	10	10	2
5	15	37.42	13.57	3
5	20	51.96	17.22	4
5	25	63.25	20.75	5
5	30	72.8	24.16	6
5	35	81.24	27.47	7
5	40	88.88	30.69	8
5	45	95.92	33.82	9
5	50	102.47	36.88	10
5	55	108.63	39.87	11
5	60	114.46	42.8	12
5	65	120	45.68	13
5	70	125.3	48.49	14
5	75	130.38	51.26	15
5	80	135.28	53.99	16
5	85	140	56.67	17
5	90	144.57	59.31	18
5	95	149	61.91	19

Q	X _{L1}	X _{L2}	X _{C1}	R ₁
5	100	153.3	64.47	20
5	105	157.48	67	21
5	110	161.55	69.49	22
5	115	165.53	71.96	23
5	120	169.41	74.39	24
5	125	173.21	76.79	25
5	130	176.92	79.17	26
5	135	180.55	81.52	27
5	140	184.12	83.85	28
5	145	187.62	86.15	29
5	150	191.05	88.43	30
5	160	197.74	92.91	32
5	170	204.21	97.31	34
5	180	210.48	101.63	36
5	190	216.56	105.88	38
5	200	222.49	110.06	40
5	210	228.25	114.17	42
5	220	233.88	118.21	44
5	230	239.37	122.2	46
5	240	244.74	126.13	48
5	250	260	130	50
5	275	262.68	139.46	55
5	300	274.77	148.64	60
5	325	286.36	157.54	65
5	350	297.49	166.21	70
5	375	308.22	174.66	75
5	400	318.59	182.91	80
5	425	328.63	190.97	85
5	450	338.38	198.85	90
5	475	347.85	206.57	95
5	500	357.07	214.14	100
5	625	400	250	125
5	750	438.75	283.12	150
5	875	474.34	314.08	175
5	1000	507.44	343.26	200
5	1125	538.52	370.95	225
5	1250	567.89	397.36	250
5	1375	595.82	422.67	275
5	1500	622.49	446.99	300
6	12	34.64	11.06	2
6	18	55.23	15.62	3
6	24	70	20	4
6	30	82.16	24.2	5
6	36	92.74	28.26	6
6	42	102.23	32.2	7
6	48	110.91	36.02	8
6	54	118.95	39.74	9
6	60	126.49	43.38	10
6	66	133.6	46.93	11
6	72	140.36	50.41	12
6	78	146.8	53.83	13
6	84	152.97	57.18	14
6	90	158.9	60.47	15
6	96	164.62	63.71	16
6	102	170.15	66.89	17
6	108	175.5	70.03	18
6	114	180.69	73.12	19
6	120	185.74	76.17	20
6	126	190.66	79.18	21
6	132	195.45	82.15	22
6	138	200.12	85.08	23
6	144	204.69	87.97	24
6	150	209.17	90.83	25
6	156	213.54	93.66	26
6	162	217.83	96.46	27
6	168	222.04	99.23	28
6	174	226.16	101.96	29

Q	X _{L1}	X _{L2}	X _{C1}	R ₁
6	180	230.22	104.67	30
6	192	238.12	110.01	32
6	204	245.76	115.25	34
6	216	253.18	120.39	36
6	228	260.38	125.45	38
6	240	267.39	130.42	40
6	252	274.23	135.31	42
6	264	280.89	140.13	44
6	276	287.4	144.88	46
6	288	293.77	149.55	48
6	300	300	154.17	50
6	330	315.04	165.44	55
6	360	329.39	176.36	60
6	390	343.15	186.97	65
6	420	356.37	197.3	70
6	450	369.12	207.36	75
6	480	381.44	217.19	80
6	510	393.38	226.79	85
6	540	404.97	236.18	90
6	570	416.23	245.38	95
6	600	427.2	254.4	100
6	750	478.28	297.13	125
6	900	524.4	336.61	150
6	1050	566.79	373.5	175
6	1200	606.22	408.29	200
6	1350	643.23	441.3	225
6	1500	678.23	472.79	250
6	1650	711.51	502.96	275
6	1800	743.3	531.96	300
7	14	50	12.5	2
7	21	70.71	17.83	3
7	28	86.6	22.9	4
7	35	100	27.78	5
7	42	111.8	32.48	6
7	49	122.47	37.04	7
7	56	132.29	41.47	8
7	63	141.42	45.79	9
7	70	150	50	10
7	77	158.11	54.12	11
7	84	165.83	58.16	12
7	91	173.21	62.12	13
7	98	180.28	66	14
7	105	187.08	69.82	15
7	112	193.65	73.58	16
7	119	200	77.27	17
7	126	206.16	80.91	18
7	133	212.13	84.5	19
7	140	217.94	88.04	20
7	147	223.61	91.53	21
7	154	229.13	94.97	22
7	161	234.52	98.37	23
7	168	239.79	101.73	24
7	175	244.95	105.05	25
7	182	250	108.33	26
7	189	254.95	111.58	27
7	196	259.81	114.79	28
7	203	264.58	117.97	29
7	210	269.26	121.11	30
7	224	278.39	127.31	32
7	238	287.23	133.39	34
7	252	295.8	139.36	36
7	266	304.14	145.23	38
7	280	312.25	151	40
7	294	320.16	156.68	42
7	308	327.87	162.27	44
7	322	335.41	167.78	46
7	336	342.78	173.21	48

Q	X _{L1}	X _{L2}	X _{C1}	R ₁
7	350	350	178.57	50
7	385	367.42	191.66	55
7	420	384.06	204.34	60
7	455	400	216.67	65
7	490	415.33	228.66	70
7	525	430.12	240.35	75
7	560	444.41	251.76	80
7	595	458.86	262.91	85
7	630	471.7	273.82	90
7	665	484.77	284.51	95
7	700	497.49	294.99	100
7	875	556.78	344.63	125
7	1050	610.33	390.49	150
7	1225	659.55	433.36	175
7	1400	705.34	473.78	200
7	1575	748.33	512.14	225
7	1750	788.99	548.73	250
7	1925	827.65	583.79	275
7	2100	864.58	617.5	300
8	8	27.39	7.6	1
8	16	63.25	14.03	2
8	24	85.15	20.1	3
8	32	102.47	25.87	4
8	40	117.26	31.42	5
8	48	130.38	36.77	6
8	56	142.3	41.95	7
8	64	153.3	46.99	8
8	72	163.55	51.9	9
8	80	173.21	56.7	10
8	88	182.35	61.39	11
8	96	191.05	65.98	12
8	104	199.37	70.49	13
8	112	207.36	74.91	14
8	120	215.06	79.26	15
8	128	222.49	83.54	16
8	136	229.67	87.74	17
8	144	236.64	91.89	18
8	152	243.41	95.97	19
8	160	250	100	20
8	168	256.42	103.97	21
8	176	262.68	107.9	22
8	184	268.79	111.77	23
8	192	274.77	115.59	24
8	200	280.62	119.38	25
8	208	286.36	123.11	26
8	216	291.98	126.81	27
8	224	297.49	130.47	28
8	232	302.9	134.09	29
8	240	308.22	137.67	30
8	256	318.59	144.73	32
8	272	328.63	151.65	34
8	288	338.38	158.46	36
8	304	347.85	165.14	38
8	320	357.07	171.71	40
8	336	366.06	178.18	42
8	352	374.83	184.56	44
8	368	383.41	190.83	46
8	384	391.79	197.02	48
8	400	400	203.13	50
8	440	419.82	218.04	55
8	480	438.75	232.49	60
8	520	456.89	246.53	65
8	560	474.34	260.2	70
8	600	491.17	273.52	75

Q	X _{L1}	X _{L2}	X _{C1}	R ₁
8	640	507.44	286.52	80
8	680	523.21	299.23	85
8	720	538.52	311.66	90
8	760	553.4	323.84	95
8	800	567.89	335.78	100
8	1000	635.41	392.36	125
8	1200	696.42	444.63	150
8	1400	752.5	493.49	175
8	1600	804.67	539.57	200
8	1800	853.67	583.29	225
8	2000	900	625	250
8	2200	944.06	664.96	275
8	2400	986.15	703.38	300
9	9	40	8.37	1
9	18	75.5	15.6	2
9	27	98.99	22.4	3
9	36	117.9	28.88	4
9	45	134.16	35.09	5
9	54	148.66	41.09	6
9	63	161.86	46.91	7
9	72	174.07	52.56	8
9	81	185.47	58.07	9
9	90	196.21	63.45	10
9	99	206.4	68.71	11
9	108	216.1	73.86	12
9	117	225.39	78.92	13
9	126	234.31	83.88	14
9	135	242.9	88.76	15
9	144	251.2	93.55	16
9	153	259.23	98.28	17
9	162	267.02	102.93	18
9	171	274.59	107.51	19
9	180	281.96	112.03	20
9	189	289.14	116.49	21
9	198	296.14	120.89	22
9	207	302.99	125.23	23
9	216	309.68	129.53	24
9	225	316.23	133.77	25
9	234	322.65	137.97	26
9	243	328.94	142.12	27
9	252	335.11	146.22	28
9	261	341.17	150.28	29
9	270	347.13	154.3	30
9	288	358.75	162.23	32
9	306	370	170	34
9	324	380.92	177.63	36
9	342	391.54	185.14	38
9	360	401.87	192.52	40
9	378	411.95	199.78	42
9	396	421.78	206.93	44
9	414	431.39	213.98	46
9	432	440.79	220.93	48
9	450	450	227.78	50
9	495	472.23	244.52	55
9	540	493.46	260.74	60
9	585	513.81	276.51	65
9	630	533.39	291.85	70
9	675	552.27	306.8	75
9	720	570.53	321.4	80
9	765	588.22	335.67	85
9	810	605.39	349.63	90
9	855	622.09	363.31	95
9	900	638.36	376.71	100
9	1125	714.14	440.24	125
9	1350	782.62	498.94	150

Q	X _{L1}	X _{L2}	X _{C1}	R ₁
9	1575	845.58	553.81	175
9	1800	904.16	605.54	200
9	2025	959.17	654.64	225
9	2250	1011.19	701.48	250
9	2475	1060.66	746.36	275
9	2700	1107.93	789.51	300
10	10	50.5	9.17	1
10	20	87.18	17.2	2
10	30	112.47	24.74	3
10	40	133.04	31.91	4
10	50	150.83	38.8	5
10	60	166.73	45.45	6
10	70	181.25	51.89	7
10	80	194.68	58.16	8
10	90	207.24	64.26	9
10	100	219.09	70.23	10
10	110	230.33	76.06	11
10	120	241.04	81.78	12
10	130	251.3	87.38	13
10	140	261.15	92.89	14
10	150	270.65	98.29	15
10	160	279.82	103.61	16
10	170	288.7	108.85	17
10	180	297.32	114.01	18
10	190	305.7	119.09	19
10	200	313.85	124.1	20
10	210	321.79	129.05	21
10	220	329.55	133.93	22
10	230	337.12	138.75	23
10	240	344.53	143.51	24
10	250	351.78	148.22	25
10	260	358.89	152.87	26
10	270	365.86	157.47	27
10	280	372.69	162.03	28
10	290	379.41	166.53	29
10	300	386.01	170.99	30
10	320	398.87	179.78	32
10	340	411.34	188.4	34
10	360	423.44	196.87	36
10	380	435.2	205.2	38
10	400	446.65	213.38	40
10	420	457.82	221.44	42
10	440	468.72	229.37	44
10	460	479.37	237.19	46
10	480	489.8	244.9	48
10	500	500	252.5	50
10	550	524.64	271.07	55
10	600	548.18	289.07	60
10	650	570.75	306.56	65
10	700	592.45	323.58	70
10	750	613.39	340.18	75
10	800	633.64	356.37	80
10	850	653.26	372.21	85
10	900	672.31	387.7	90
10	950	690.83	402.87	95
10	1000	708.87	417.74	100
10	1250	792.94	488.23	125
10	1500	868.91	553.36	150
10	1750	938.75	614.25	175
10	2000	1003.74	671.66	200
10	2250	1064.78	726.14	225
10	2500	1122.5	778.12	250
10	2750	1177.39	827.92	275
10	3000	1229.84	875.8	300



Motorola reserves the right to make changes without further notice to any products herein. Motorola makes no warranty, representation or guarantee regarding the suitability of its products for any particular purpose, nor does Motorola assume any liability arising out of the application or use of any product or circuit, and specifically disclaims any and all liability, including without limitation consequential or incidental damages. "Typical" parameters can and do vary in different applications. All operating parameters, including "Typicals" must be validated for each customer application by customer's technical experts. Motorola does not convey any license under its patent rights nor the rights of others. Motorola products are not designed, intended, or authorized for use as components in systems intended for surgical implant into the body, or other applications intended to support or sustain life, or for any other application in which the failure of the Motorola product could create a situation where personal injury or death may occur. Should Buyer purchase or use Motorola products for any such unintended or unauthorized application, Buyer shall indemnify and hold Motorola and its officers, employees, subsidiaries, affiliates, and distributors harmless against all claims, costs, damages, and expenses, and reasonable attorney fees arising out of, directly or indirectly, any claim of personal injury or death associated with such unintended or unauthorized use, even if such claim alleges that Motorola was negligent regarding the design or manufacture of the part. Motorola and  are registered trademarks of Motorola, Inc. Motorola, Inc. is an Equal Opportunity/Affirmative Action Employer.

Literature Distribution Centers:

USA: Motorola Literature Distribution; P.O. Box 20912; Phoenix, Arizona 85036.

EUROPE: Motorola Ltd.; European Literature Centre; 88 Tanners Drive, Blakelands, Milton Keynes, MK14 5BP, England.

JAPAN: Nippon Motorola Ltd.; 4-32-1, Nishi-Gotanda, Shinagawa-ku, Tokyo 141, Japan.

ASIA PACIFIC: Motorola Semiconductors H.K. Ltd.; Silicon Harbour Center, No. 2 Dai King Street, Tai Po Industrial Estate, Tai Po, N.T., Hong Kong.

**MOTOROLA**

For More Information On This Product,
Go to: www.freescale.com

AN267/D