



# 16-Bit I<sup>2</sup>C-Bus LED Driver with Programmable Blink Rates

## PCA9552

Last Updated: Sep 5, 2022

The PCA9552 LED blinker blinks LEDs in I<sup>2</sup>C-bus and SMBus applications where it is necessary to limit bus traffic or free up the I<sup>2</sup>C-bus controller's (MCU, MPU, DSP, chipset, etc.) timer. The uniqueness of this device is the internal oscillator with two programmable blink rates. To blink LEDs using normal I/O expanders like the PCF8574 or PCA9554, the bus controller must send repeated commands to turn the LED on and off. This greatly increases the amount of traffic on the I<sup>2</sup>C-bus and uses up one of the controller's timers. The PCA9552 LED blinker instead requires only the initial setup command to program BLINK RATE 1 and BLINK RATE 2 (that is, the frequency and duty cycle) for each individual output. From then on, only one command from the bus controller is required to turn each individual open-drain output on, off, or to cycle at BLINK RATE 1 or BLINK RATE 2. Maximum output sinks current is 25 mA per bit and 200 mA per package.

Any bits not used for controlling the LEDs can be used for General Purpose Parallel Input/Output (GPIO) expansion.

The active LOW hardware reset pin (RESET) and Power-On Reset (POR) initializes the registers to their default state, all zeroes, causing the bits to be set HIGH (LED off).

Three hardware address pins on the PCA9552 allow eight devices to operate on the same bus.

## PCA955 Block Diagram Block Diagram

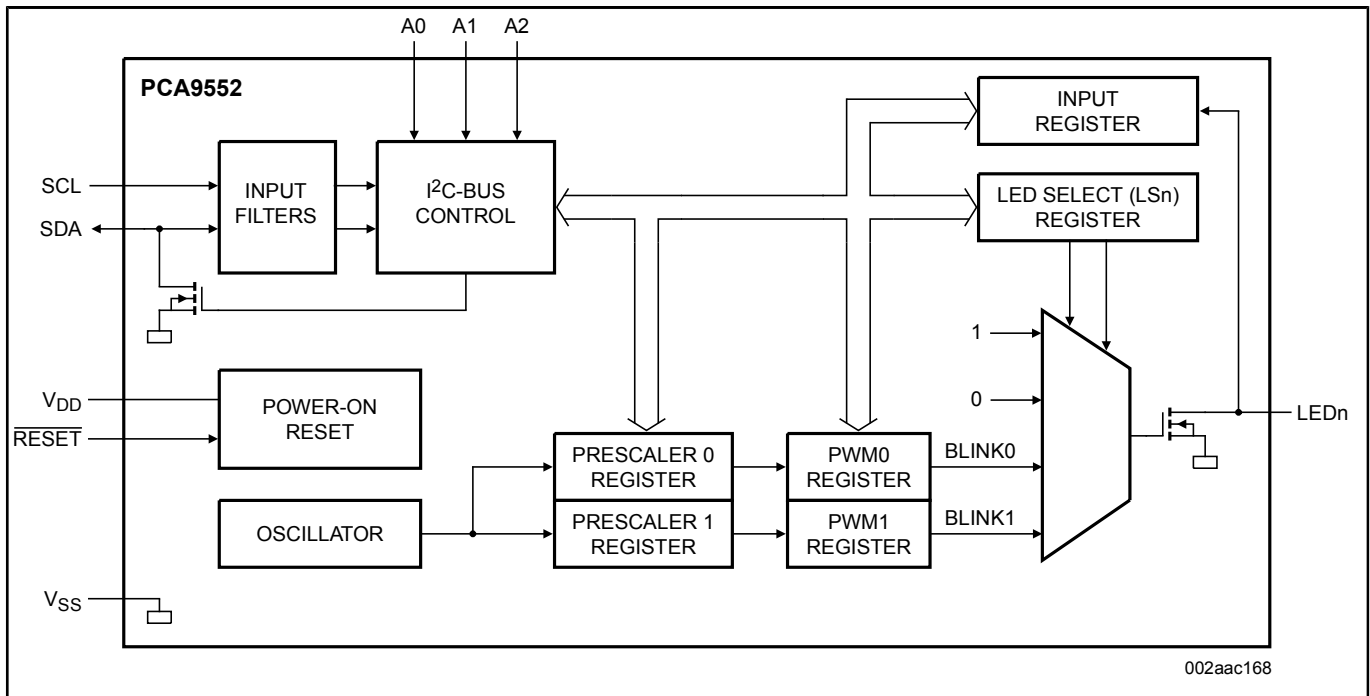

## Block diagram: PCA9552BS, PCA9552D, PCA9552PW Block Diagram

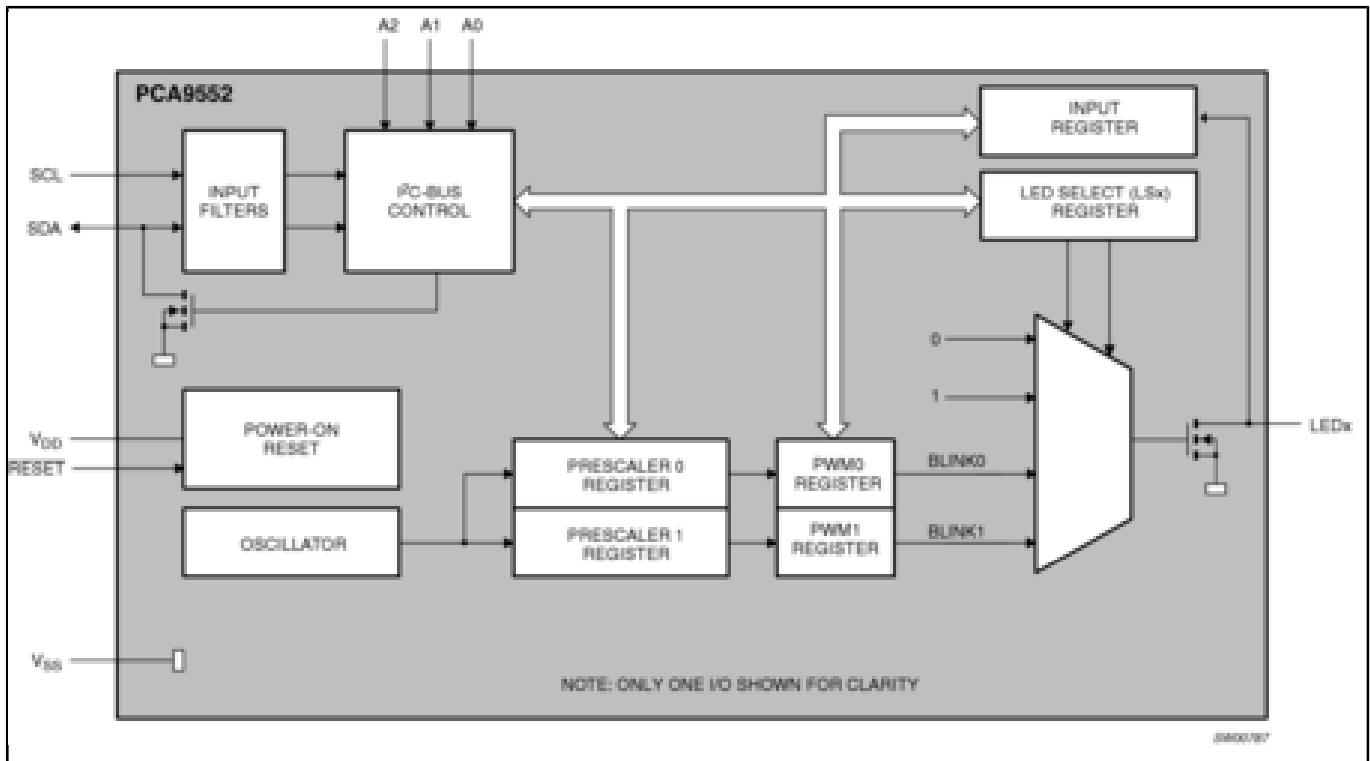

View additional information for [16-Bit I<sup>2</sup>C-Bus LED Driver with Programmable Blink Rates](#).

**Note:** The information on this document is subject to change without notice.

---

**[www.nxp.com](http://www.nxp.com)**

NXP and the NXP logo are trademarks of NXP B.V. All other product or service names are the property of their respective owners. The related technology may be protected by any or all of patents, copyrights, designs and trade secrets. All rights reserved. © 2024 NXP B.V.