



Single-chip 16-bit/32-bit MCU; up to 128 kB flash with ISP/IAP, Ethernet, USB 2.0 device/host/OTG, CAN, and 10-bit ADC/DAC

LPC2361FBD100

新規採用非推奨

このページでは、新規設計を推奨しない製品に関する情報を掲載しています。

Last Updated: Apr 8, 2022

The LPC2361/2362 microcontrollers are based on a 16-bit/32-bit Arm7TDMI-S™ CPU with real-time emulation that combines the microcontroller with up to 128 kB of embedded high-speed flash memory. A 128-bit wide memory interface and a unique accelerator architecture enable 32-bit code execution at the maximum clock rate. For critical performance in interrupt service routines and DSP algorithms, this increases performance up to 30 % over Thumb mode. For critical code size applications, the alternative 16-bit Thumb mode reduces code by more than 30 % with minimal performance penalty.

The LPC2361/2362 are ideal for multi-purpose serial communication applications. They incorporate a 10/100 Ethernet Media Access Controller (MAC) (LPC2362 only), USB full speed device with 4 kB of endpoint RAM, four UARTs, two CAN channels, an SPI interface, two Synchronous Serial Ports (SSP), three I²C interfaces, and an I²S interface. This blend of serial communications interfaces combined with an on-chip 4 MHz internal oscillator, SRAM of up to 32 kB, 16 kB SRAM for Ethernet (available as general purpose SRAM for the LPC2361), 8 kB SRAM for USB and general purpose use, together with 2 kB battery powered SRAM make these devices very well suited for communication gateways and protocol converters. Various 32-bit timers, an improved 10-bit ADC, 10-bit DAC, one PWM unit, a CAN control unit, and up to 70 fast GPIO lines with up to 12 edge or level sensitive external interrupt pins make these microcontrollers particularly suitable for industrial control and medical systems.

Block diagram: LPC2361FBD100, LPC2362FBD100 Block Diagram

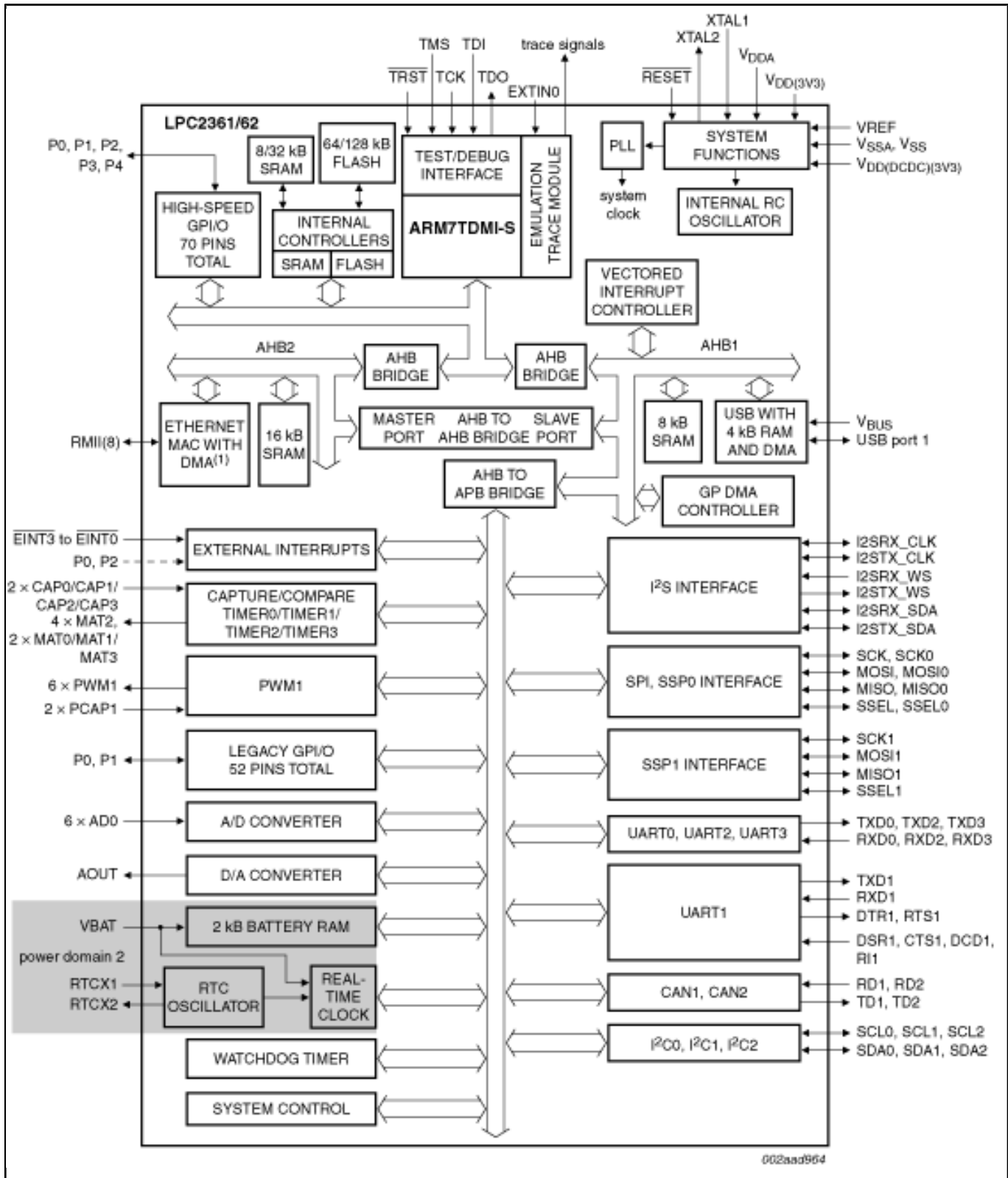

View additional information for [Single-chip 16-bit/32-bit MCU; up to 128 kB flash with ISP/IAP, Ethernet, USB 2.0 device/host/OTG, CAN, and 10-bit ADC/DAC.](#)

Note: The information on this document is subject to change without notice.

www.nxp.com

NXP and the NXP logo are trademarks of NXP B.V. All other product or service names are the property of their respective owners. The related technology may be protected by any or all of patents, copyrights, designs and trade secrets. All rights reserved. © 2024 NXP B.V.